

















































Contents























Component wiring diagram index	2
Component wiring diagrams	6
Illustrations	47
Circuit board (32) electrical centre	114
Fuses on circuit board (32) electrical centre	116
Relays on circuit board (32) electrical centre	117
6-unit fuse holder	118
Cable harness illustration index	119
List of connectors	122
List of components	128
Abbreviations	133
Cable colour code	134
Feedback	

Component wiring diagram index

		AA	Starter motor, alternator, 24 V	page 6			
					BB	Coolant level, preheating, exhaust pressure governor, exhaust brake, range inhibitor, interval wiping	page 7
B = Contact extra exhaust brake (RHD)							
	BG	Engine shut-off	page 7				
	BK	Speed limiter	page 8				
A = VDO							
B = Econocruise							
	BN	EDC, electronically controlled fuel injection	page 9				
H = MGS							
J = AGS							
P = Powertronic							
		CE	Parking lights, side marker lights, roof lights, tail lights full beams, dipped beams, spotlights	page 10			
	CF	Bulb, position light at mirror	page 11				
	CG	Fog lights	page 11				
	CH	Side marker lights	page 11				
	CK	Brake lights	page 12				
A = AUS							
		CN	Direction indicator, hazard warning lights	page 12			
A = AUS							
	CS	Voltage converter	page 12				
	EA	Reversing lights	page 13				
	ED	Loading light, fifth wheel light	page 13				
	EG	Rear fog lights	page 13				

	EN	Rotating warning light	page 13
	ER	Interior lights, low cab	page 14
	EV	Cigarette lighter, lighting el. distribution center	page 14
	FA	Horn	page 14
	FB	Reverse warner	page 14
	GA	Windscreen wipers and washers, headlamp wipers and washers	page 15
		A = Normal chassis	
		B = High chassis	
	HA	Climate unit (air conditioning)	page 16
		A = CU-ACAUT	
		B = CU-ACMAN	
		C = CU-HEAT	
	DW 80 HC	Parking heater DW80	page 18
		A = CU-ACAUT	
		B = CU-ACMAN	
		C = CU-HEAT	
	HD	Heated seat	page 19
	HG	Electrically heated rearview mirror	page 19
	HH	Electrically operated rearview mirror	page 19
		A = VAB2500	
		B = VAB2600	
	HK	Air dryer	page 20
	JA	Radio, communication radio and loudspeakers	page 20
		A = RHD	

	KA	Electrically operated window winder	page 21
	KD	Seat belt	page 21
	LD	Power take-off	page 22
		A = Power take-off	
		B = Double power take-off	
	LE	Power take-off, clutch-independent	page 23
	LG	Diff. lock	page 23
	LJ	Lock, self-steered axle	page 24
	LK	Automatic transmission	page 25
		J = Powertronic	
	LO	Geartronic	page 26
	LP	Powertronic	page 28
	MA	Bogie lift (hydraulic)	page 29
	MD	Bogie lift (hydraulic), with axle load limiter	page 30
	MG	Bogie lift (air-operated)	page 31
	MK	Bogie lift (air-operated), with axle load limiter	page 31
	MN	Air suspension	page 32
		A = Tractor	
		B = Rigid	
		C = INFOSYST	
		D = KONVSYST	
		E = Bogie lift air suspension < 15 tonnes	
		F = Bogie lift air suspension 15 tonnes	
		G = Bogie press	

		MP	Bogie lift, air suspension < 15 tonnes	page 33
		MR	Bogie lift, air suspension, pusher	page 34
		MS	Bogie lift, air suspension 15 tonnes	page 35
		MV	Drive axle load-increase	page 35
		MX	Bogie press	page 36
		MY	Bogie lift, tridem	page 36
		NA	Combination instrument	page 37
A = Without tachograph				
		ND	Indicator lamps	page 38
		NG	Instruments, buzzer, rheostat	page 39
		NK	Driver information system (INFOSYST)	page 40
		OA	Anti-lock brakes (ABS), 4-channel	page 41
		OB	Anti-lock brakes (ABS), 6-channel	page 42
		PA	Level control, headlights	page 43
		XA	6-unit fuse holder	page 43
		XD	Connection, extra equipment	page 44
A = AVGASB4				
B = Powertronic				
		ZA	Earth connections	page 45
		ZD	Joint sleeve	page 46

Component wiring diagrams

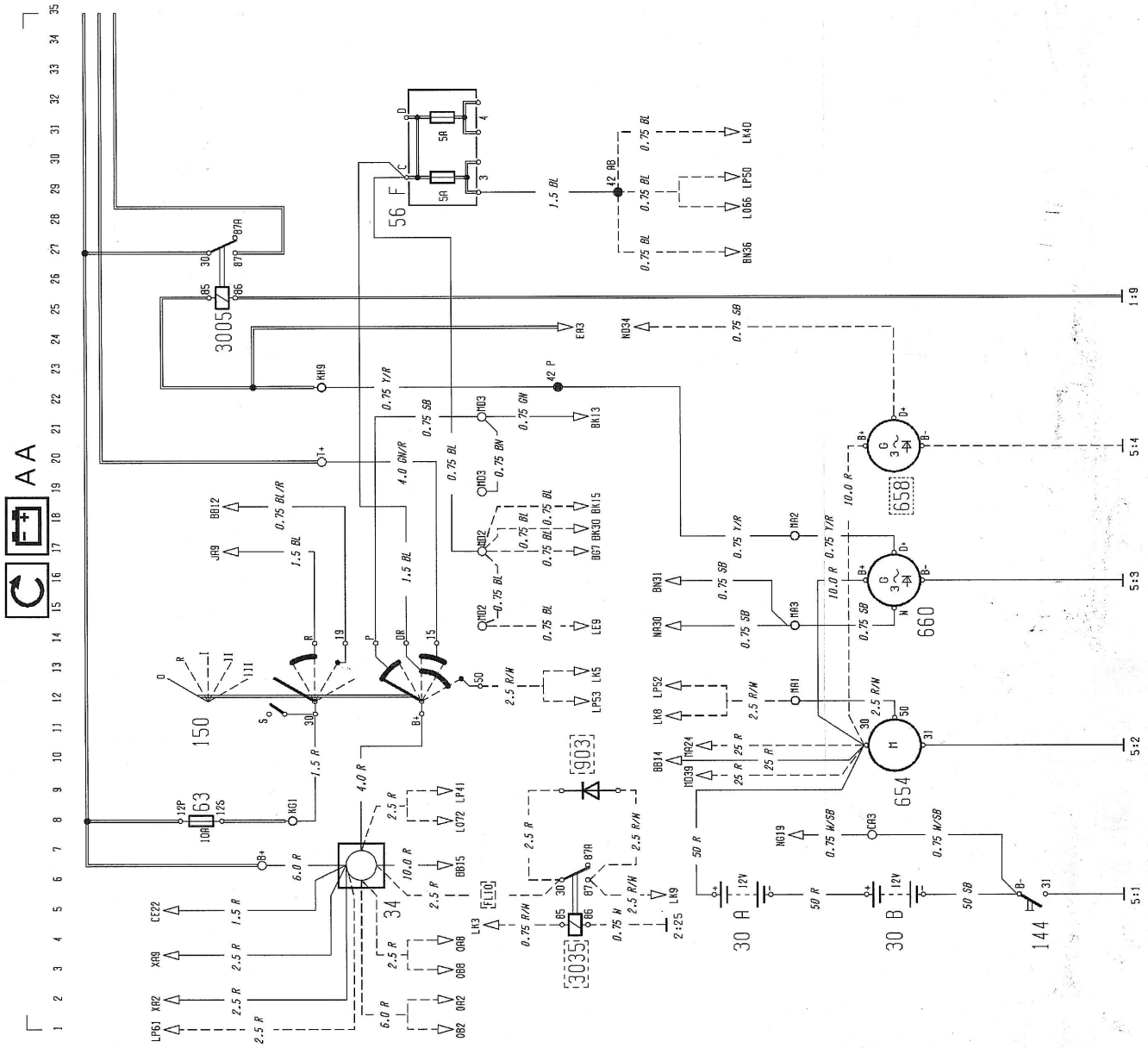

T3008262

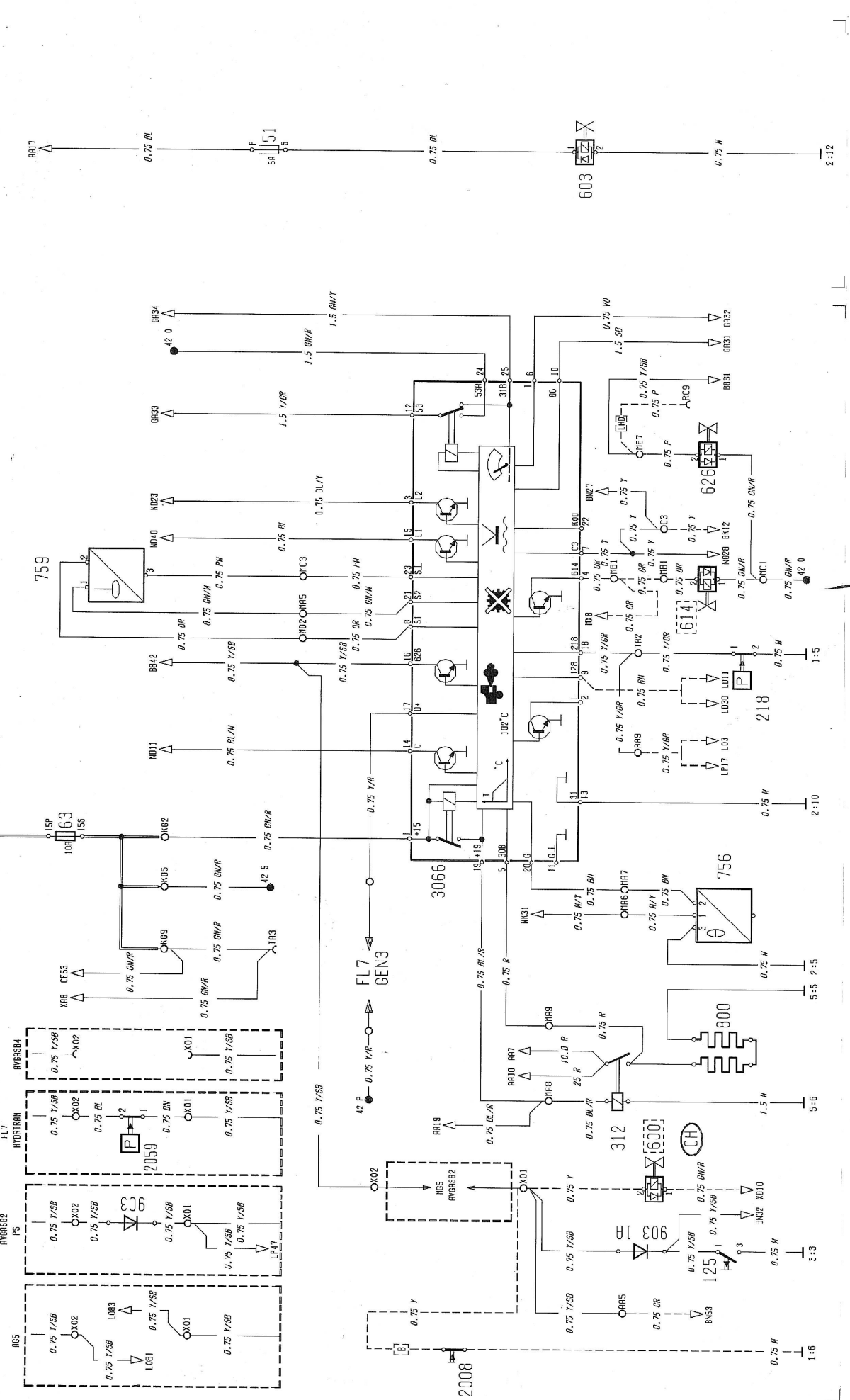
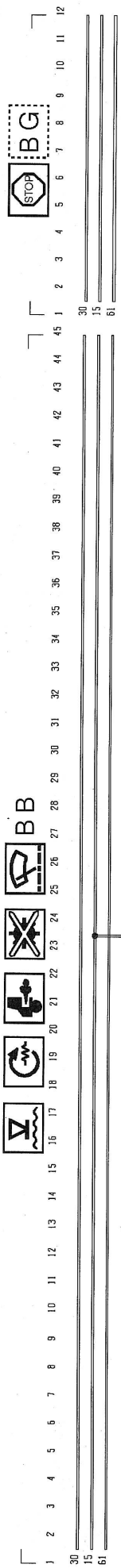

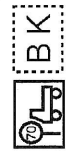

- 1
- 2
- 3
- 4
- 5
- 6
- 7
- 8
- 9
- 10
- 11
- 12
- 13
- 14
- 15
- 16
- 17
- 18
- 19
- 20
- 21
- 22
- 23
- 24
- 25
- 26
- 27
- 28
- 29
- 30
- 31
- 32
- 33
- 34
- 35
- 36
- 37
- 38
- 39
- 40

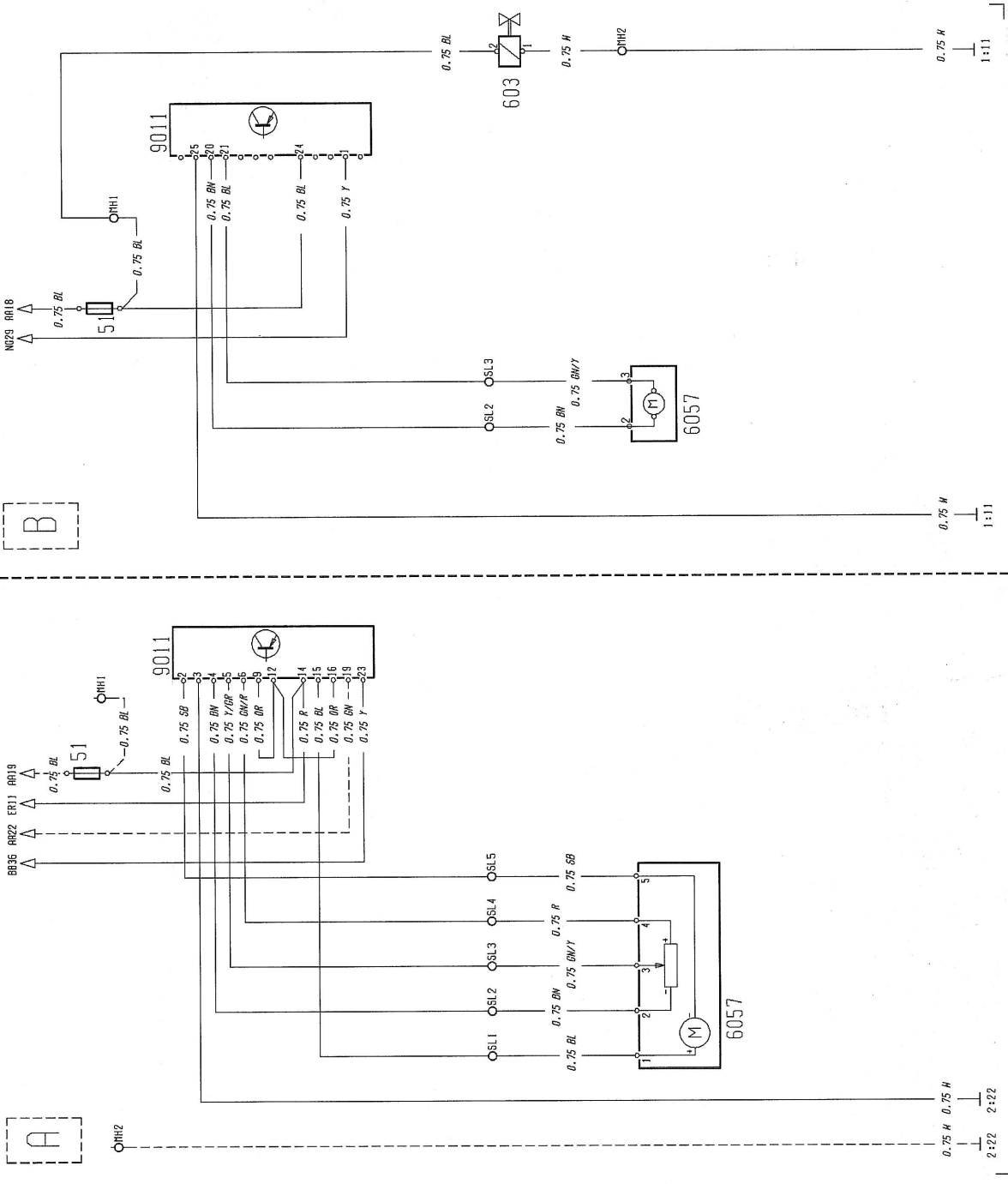

T3008264

EDC BN

1 2 3 4 5 6 7 8 9 10 11 12 13 14 15 16 17 18 19 20 21 22 23 24 25 26 27 28 29 30 31 32 33 34 35 36 37 38 39 40 41 42 43 44 45 46 47 48 49 50 51 52 53 54 55 56 57 58 59 60 61 62 63 64 65 66 67 68 69 70

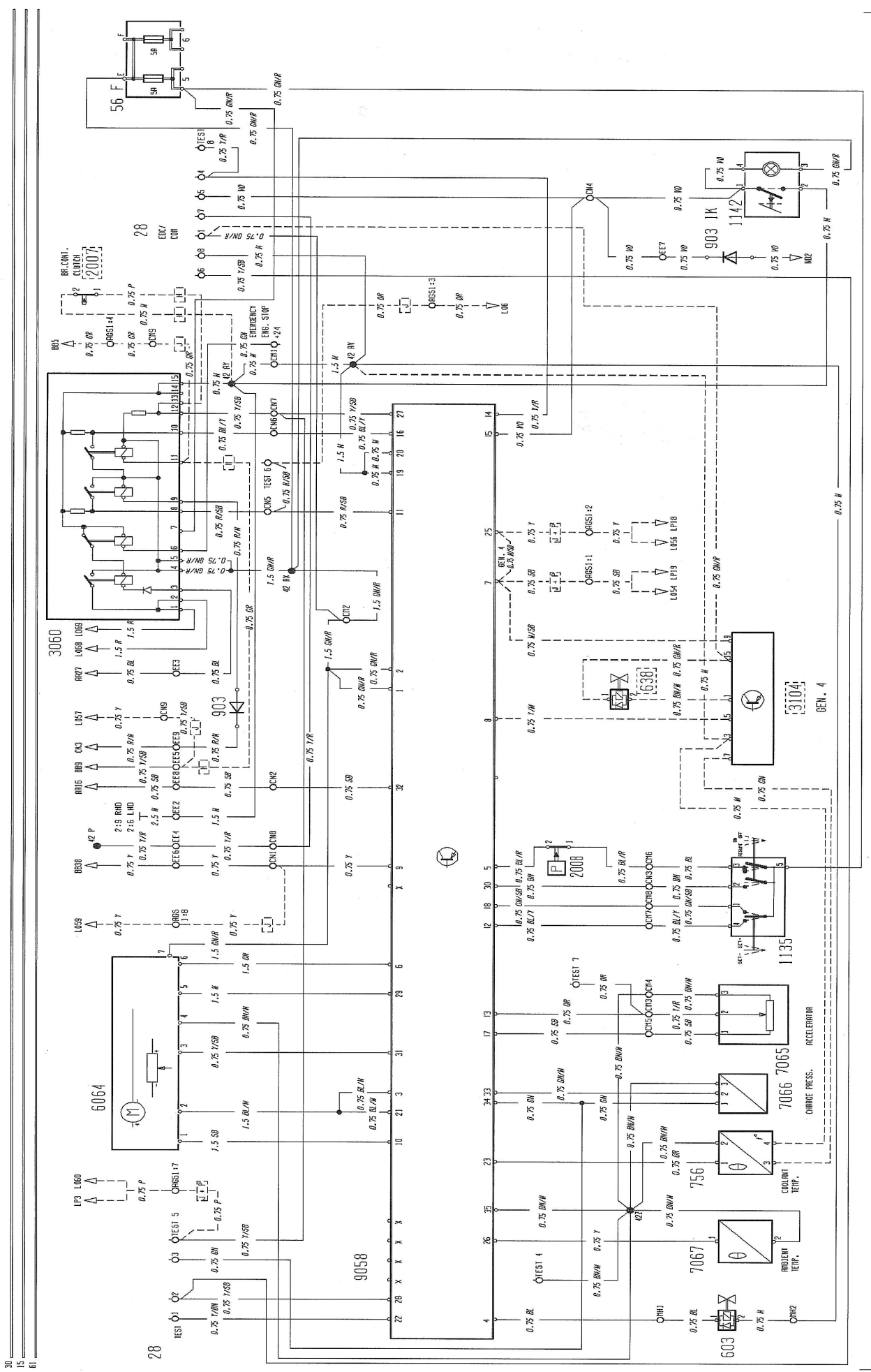

Component wiring diagrams

Group 37 Wiring Diagram

This is the cut pages sample. Download all 134 page(s) at: ManualPlace.com

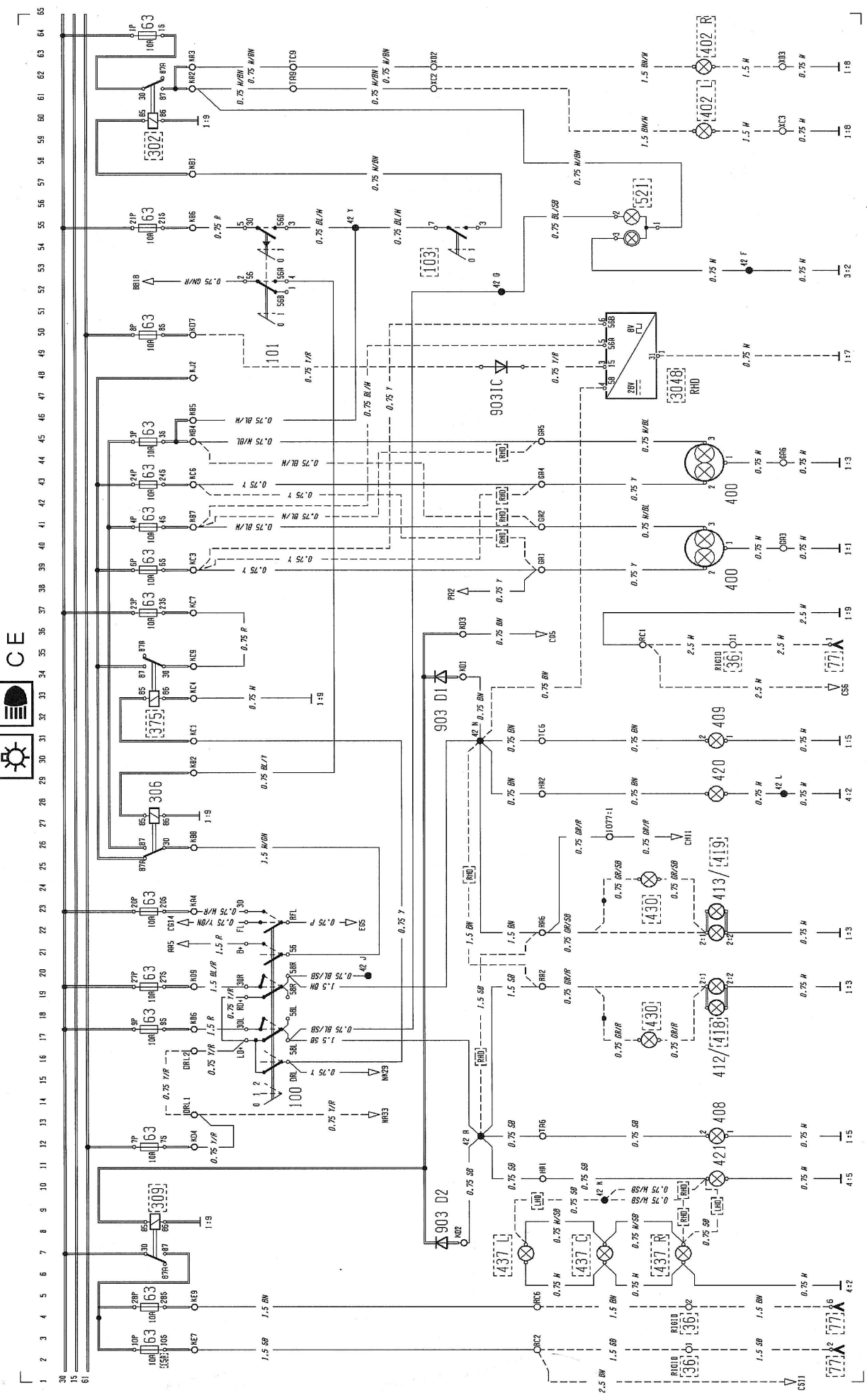

CE