



Volkswagen Passat

Official Factory Repair Manual

1995

Gasoline, Turbo Diesel, TDI

4-cylinder and VR6, including wagon

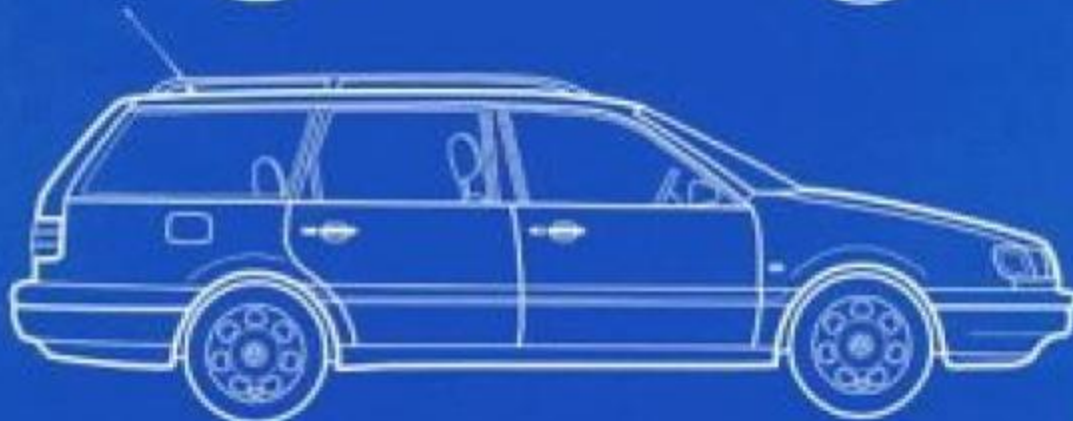
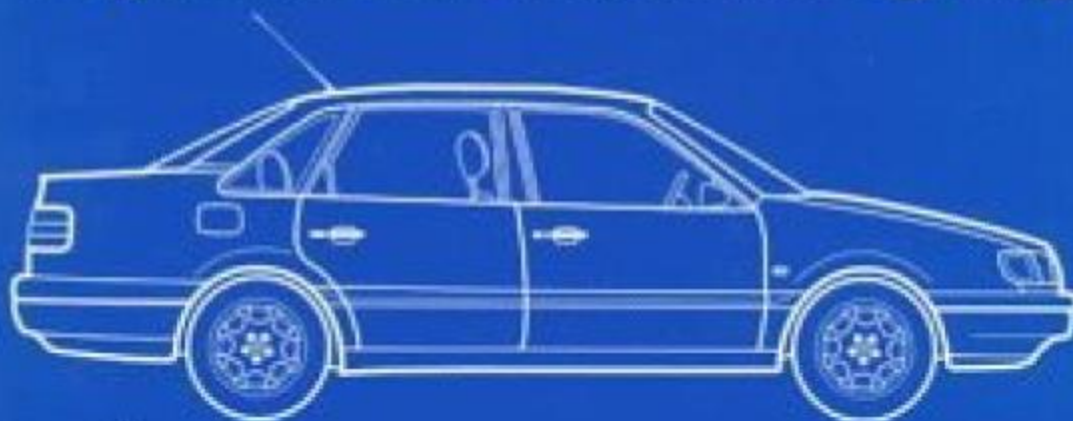

Richard Bentley

PASSAT '95-'97



Wiring diagram layout

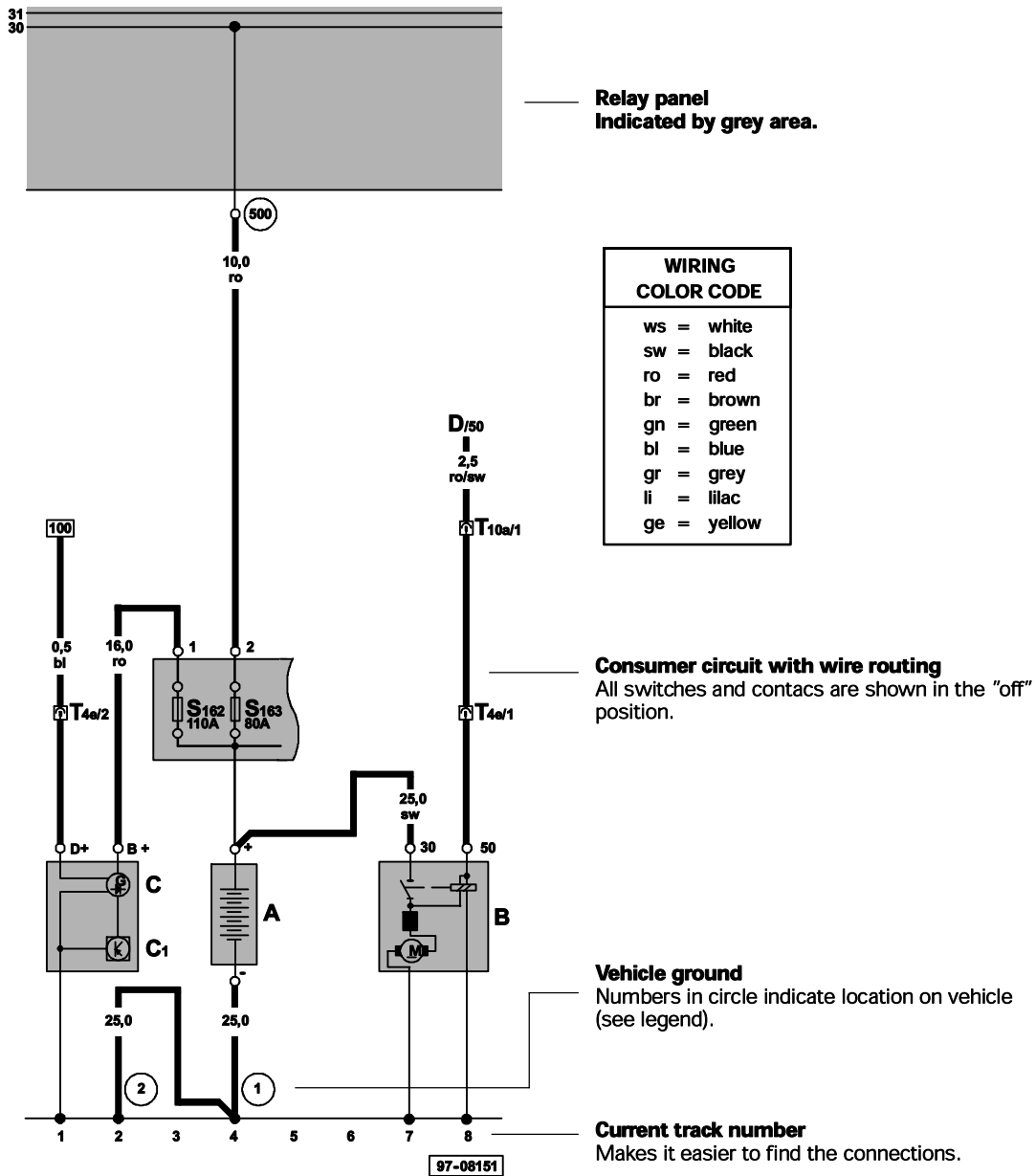

- A - Battery
- B - Starter
- C - Generator (GEN)
- C1 - Voltage Regulator (VR)
- D - Ignition/Starter Switch
- S162 - Fuse -1- (30) in fuse bracket / battery
- S163 - Fuse -2- (30) in fuse bracket / battery
- T4e - 4-Pin Connector, on transmission
- T10a - 10-Pin Connector, on protective housing for control module, in engine compartment, left
- ① - Ground strap, battery to body
- ② - Ground strap, transmission to body
- ⑤00 - Screw connection -1- (30), on relay panel

Legend
In all wiring diagrams the same component designation (code) is used for a particular component; for example, always A for battery.

How to read wiring diagrams

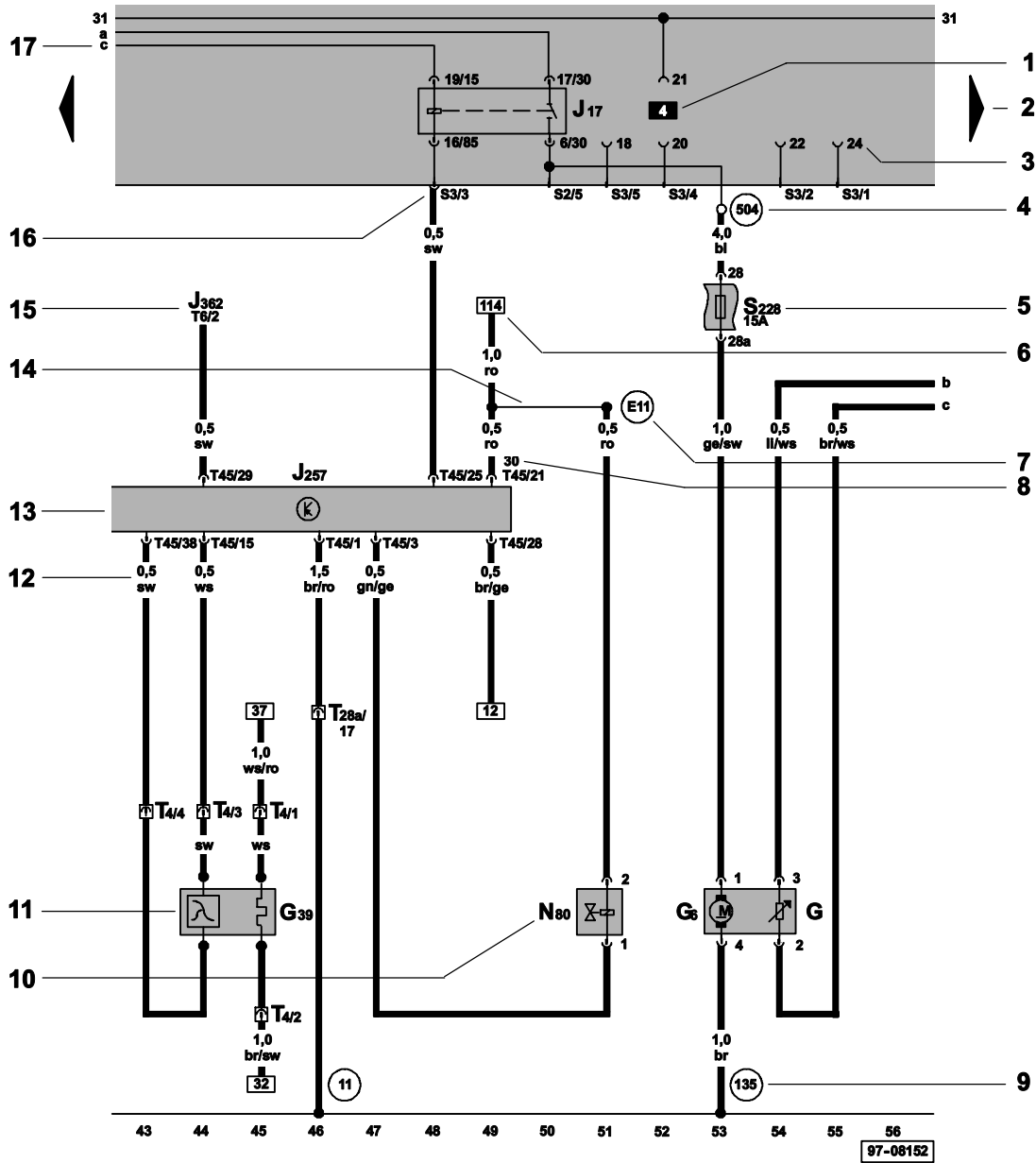









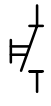

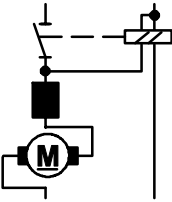

How to read wiring diagrams

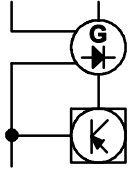
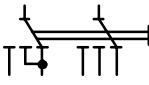
- 1 - Relay location number**
Indicates location on relay panel.
- 2 - Arrow**
Indicates wiring circuit is continued on the previous and/or next page.
- 3 - Connection designation - relay control module on relay panel**
Shows the individual terminals in a multi-point connector.
For example: contact 24 on terminal **4** on relay panel.
- 4 - Diagram of threaded pin on relay panel**
White circle shows a detachable connection.
- 5 - Fuse designation**
For example: S228 = Fuse number 28, 15 amps, in fuse holder
- 6 - Reference of wire continuation (current track number)**
Number in frame indicates current track where wire is continued.
- 7 - Wire connection designation in wiring harness**
Location of wire connections are indicated in the legend.
- 8 - Terminal designation**
Designation which appears on actual component and/or terminal number of a multi-point connector.
- 9 - Ground connection designation in wire harness**
Locations of ground connections are indicated in legend.
- 10 - Component designation**
Use legend at bottom of page to identify the component code.
- 11 - Component symbols (see page IV - VI)**
- 12 - Wire cross-section size (in mm²) and wire colors**
Abbreviations are explaining in color chart beside the wiring diagram.
- 13 - Component symbol with open drawing side**
Indicated component is continued on another wiring diagram. The number of corresponding wiring diagram can taken from list of contents.
- 14 - Internal connections (thin lines)**
These connections are **not** wires. Internal connections are current carrying and are listed to allow tracing of current flow inside components and wiring harness.
- 15 - Reference of continuation of wire to component**
For example: Control module for anti-theft immobilizer J362 on 6-Pin Connector, terminal 2
- 16 - Relay panel connectors**
Shows wiring of multi-point or single connectors on relay panel
For example: S3/3 - Multi-point connector S3, terminal 3
- 17 - Reference of internal connection continuation**
Letters indicate where connection continues on the previous and/or next page.

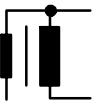
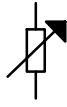
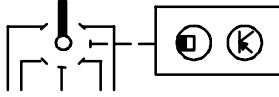



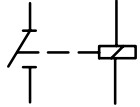

















Symbols used in wiring diagrams

	Fuse		Switch (manually operated)
	Thermo-fuse (Circuit Breaker)		Switch (thermally operated)
	Battery		Push button switch (manually operated)
	Starter		Switch (mechanically operated)
	Switch (pressure operated)		Generator (GEN)
	Multiple switch (manually operated)		Resistance
	Ignition Coil		Variable resistor (Rheostat)
	Distributor (electronic)		Resistor temperature dependent
	Spark plug connector and plug		Heater element temperature dependent
	Glow plug Heater element		Relay

97-12201

Symbols used in wiring diagrams

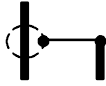
	Diode		Solenoid valve
	Zener diode		Magnetic clutch
	Diode light sensitiv		Wire connector
	Light bulb		Pin connector
	Light bulb (dual filament)		Multi-point connector at component
	LED		Internal connections in component
	Interior light		Wire connection detachable
	Instrument (Gauge)		Wire connection fixed
	Electronic control module		Wire connection in wiring harness
	Rear window defogger heat element		Resistance wire
	Cigarette lighter		Shield wire

97-08153

Symbols used in wiring diagrams

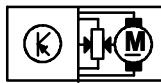

Control motor, headlight range adjustment



Speaker



Motor

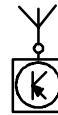

Antenna with electronic antenna amplifier

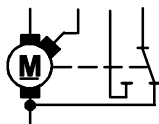

Wiper motor 2-speed

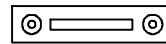

Radio



Crankshaft position sensor (CKP)

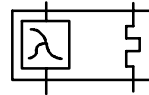

Heated oxygen sensor

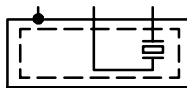

Knock sensor (KS)



Analog clock

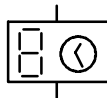

Digital clock

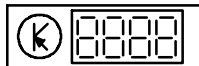

Multi-function indicator



Airbag spiral spring



Speed sensor

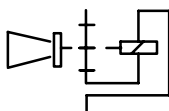

Horn

97-08154

Explanation of troubleshooting procedures

Starting with the reported problem, troubleshooting procedures show step-by-step **what** is checked and **how** it is checked in order to find the problem in the quickest and most reliable way. If several causes (of a problem) are possible in one system, a test procedure is used for diagnosis.

Structure of a Test step:

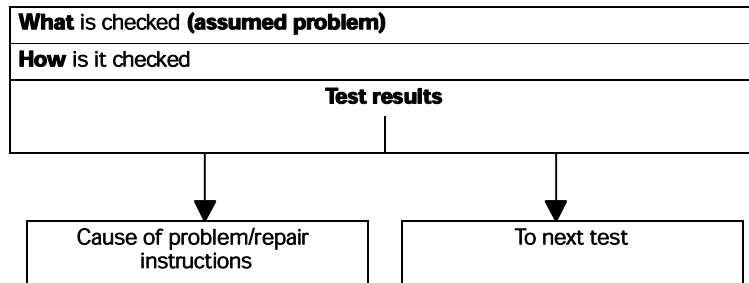

Example of a troubleshooting procedure:

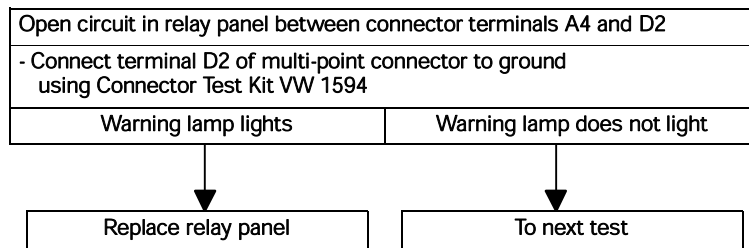

Passat (2.8L-Engine - Motronic Multiport Fuel Injection (MFI)/128kW), code AAA, from August 1994

Diagram Title	Num/Page
- <u>Passat (2.8L-Engine - Motronic Multiport Fuel Injection (MFI)/128kW), code AAA, from August 1994</u>	<u>02/01</u>
- <u>Battery, ignition/starter switch</u>	<u>01/02</u>
- <u>Fresh air blower</u>	<u>01/03</u>
- <u>Coolant fan, two speeds</u>	<u>03/01</u>
- <u>Generator (GEN), starter, fuel pump (FP), fuel level sensor</u>	<u>02/02</u>
- <u>Ignition system, motronic engine control module (ECM), heated oxygen sensor (HO2S), heated oxygen sensor (HO2S) relay</u>	<u>02/03</u>
- <u>Motronic engine control module (ECM), knock sensors, throttle position (TP) sensor, engine coolant temperature (ECT) sensor</u>	<u>02/04</u>
- <u>Motronic engine control module (ECM), injectors, mass air flow (MAF) sensor</u>	<u>02/05</u>
- <u>Motronic engine control module (ECM), EGR vacuum regulator solenoid valve, EGR temperature sensor</u>	<u>02/06</u>
- <u>Motronic engine control module (ECM) power supply relay, secondary air injection (AIR) system</u>	<u>02/07</u>
- <u>Instrument cluster, engine coolant level/temperature (ECL/ECT) warning light, visual and acoustical oil pressure control, odometer display, fuel gauge</u>	<u>02/09</u>
- <u>Instrument cluster, tachometer</u>	<u>01/05</u>
- <u>Instrument cluster, digital clock</u>	<u>01/06</u>
- <u>Instrument cluster, outside air temperature sensor, parking brake warning light switch and brake fluid level warning light switch</u>	<u>01/07</u>
- <u>Interior light, luggage compartment light, radio/parking light warning buzzer, seat belt warning system relay, door contact switch</u>	<u>01/08</u>
- <u>Data link Connector (DLC) wire connection, radio connection, cigarette lighter, ashtray light</u>	<u>01/09</u>
- <u>Headlights, front side markers, headlight dimmer flasher switch</u>	<u>01/10</u>
- <u>Turn signal and emergency flasher system, parking light switch</u>	<u>01/11</u>
- <u>Tail lights, brake lights, turn signal lights</u>	<u>01/12</u>
- <u>Light switch, right front turn signal light</u>	<u>01/13</u>
- <u>Fog lights, license plate lights, back-up lights</u>	<u>01/14</u>
- <u>Rear window defogger heat element, dual horns</u>	<u>01/15</u>
- <u>Windshield wiper/washer system</u>	<u>01/16</u>
- <u>Rear window wiper/washer system, ABS warning light, airbag malfunction indicator lamp (MIL), brake and parking brake warning light</u>	<u>01/17</u>

Passat (1.9L-Engine - Turbo Diesel Fuel Injection (DFI)/55kW), code AAZ, from August 1994

Diagram Title	Num/Page
- <u>Passat (1.9L-Engine - Turbo Diesel Fuel Injection (DFI)/55kW), code AAZ, from August 1994</u>	<u>17/01</u>
- <u>Battery, ignition/starter switch</u>	<u>01/02</u>
- <u>Fresh air blower</u>	<u>01/03</u>
- <u>Coolant fan, two speeds, 250W, code AAZ, from August 1994</u>	<u>04/01</u>
- <u>Generator (GEN), starter</u>	<u>17/02</u>
- <u>Automatic glow time control module, fuel cut-off valve, idle air control (IAC) solenoid, injection start positioner</u>	<u>17/03</u>
- <u>Spark plugs, engine temperature sensor</u>	<u>17/04</u>
- <u>Visual and acoustical oil pressure control, positive crankcase ventilation (PCV) heating element, fuel gauge</u>	<u>17/05</u>
- <u>Instrument cluster, tachometer</u>	<u>01/05</u>
- <u>Instrument cluster, digital clock</u>	<u>01/06</u>
- <u>Instrument cluster, outside air temperature sensor, parking brake warning light switch and brake fluid level warning light switch</u>	<u>01/07</u>
- <u>Interior light, luggage compartment light, radio/parking light warning buzzer, seat belt warning system relay, door contact switch</u>	<u>01/08</u>
- <u>Data link Connector (DLC) wire connection, radio connection, cigarette lighter, ashtray light</u>	<u>01/09</u>
- <u>Headlights, front side markers, headlight dimmer flasher switch</u>	<u>01/10</u>
- <u>Turn signal and emergency flasher system, parking light switch</u>	<u>01/11</u>
- <u>Tail lights, brake lights, turn signal lights</u>	<u>01/12</u>
- <u>Light switch, right front turn signal light</u>	<u>01/13</u>
- <u>Fog lights, license plate lights, back-up lights</u>	<u>01/14</u>
- <u>Rear window defogger heat element, dual horns</u>	<u>01/15</u>
- <u>Windshield wiper/washer system</u>	<u>01/16</u>
- <u>Rear window wiper/washer system, ABS warning light, airbag malfunction indicator lamp (MIL), brake and parking brake warning light</u>	<u>01/17</u>

Passat (2.0L-Engine - Motronic Multiport Fuel Injection (MFI)/85kW), code ABA, from February 1995

Diagram Title	Num/Page
- <u>Passat (2.0L-Engine - Motronic Multiport Fuel Injection (MFI)/85kW), code ABA, from February 1995</u>	<u>24/01</u>
- <u>Battery, ignition/starter switch</u>	<u>01/02</u>
- <u>Fresh air blower</u>	<u>01/03</u>
- <u>Coolant fan, two speeds</u>	<u>03/01</u>
- <u>Generator (GEN), starter, fuel pump (FP), fuel level sensor</u>	<u>24/02</u>
- <u>Motronic engine control module (ECM), heated oxygen sensor (HO2S) relay, heated oxygen sensor (HO2S), fuel pump (FP) relay</u>	<u>24/03</u>
- <u>Motronic engine control module (ECM), knock sensor (KS), throttle position (TP) sensor, engine coolant temperature (ECT) sensor, intake air temperature (IAT) sensor, EGR temperature sensor</u>	<u>24/04</u>
- <u>Motronic engine control module (ECM), injectors, idle air control (IAC) valve, mass air flow (MAF) sensor</u>	<u>24/05</u>
- <u>Motronic engine control module (ECM), motronic engine control module (ECM) power supply relay, engine speed (RPM) sensor</u>	<u>24/06</u>
- <u>Speedometer vehicle speed sensor (VSS), outside air temperature sensor, oil temperature sensor, oil pressure switch</u>	<u>24/07</u>
- <u>Instrument cluster, engine coolant level/temperature (ECL/ECT) warning light, visual and acoustical oil pressure control, fuel gauge, odometer display</u>	<u>24/08</u>
- <u>Instrument cluster, speedometer, multi-function indicator memory switch</u>	<u>24/09</u>
- <u>Instrument cluster, tachometer</u>	<u>01/05</u>
- <u>Instrument cluster, digital clock</u>	<u>01/06</u>
- <u>Instrument cluster, outside air temperature sensor, parking brake warning light switch and brake fluid level warning light switch</u>	<u>01/07</u>
- <u>Interior light, luggage compartment light, radio/parking light warning buzzer, seat belt warning system relay, door contact switch</u>	<u>01/08</u>
- <u>Data link Connector (DLC) wire connection, radio connection, cigarette lighter, ashtray light</u>	<u>01/09</u>
- <u>Headlights, front side markers, headlight dimmer flasher switch</u>	<u>01/10</u>
- <u>Turn signal and emergency flasher system, parking light switch</u>	<u>01/11</u>
- <u>Tail lights, brake lights, turn signal lights</u>	<u>01/12</u>
- <u>Light switch, right front turn signal light</u>	<u>01/13</u>
- <u>Fog lights, license plate lights, back-up lights</u>	<u>01/14</u>
- <u>Rear window defogger heat element, dual horns</u>	<u>01/15</u>
- <u>Windshield wiper/washer system</u>	<u>01/16</u>
- <u>Rear window wiper/washer system, ABS warning light, airbag malfunction indicator lamp (MIL), brake and parking brake warning light</u>	<u>01/17</u>

Common Systems

Diagram Title	Num/Page
- <u>Airbag, from August to September 1994</u>	<u>25/01</u>
- <u>Airbag, from October</u>	<u>18/01</u>
- <u>Air conditioning, 2.8L Engine-Motronic Multiport Fuel Injection (MFI)/128kW, code AAA, from August 1994</u>	<u>06/01</u>
- <u>Air conditioning, 2.0L Engine-Motronic Multiport Fuel Injection (MFI)/85kW, code ABA, from February 1995</u>	<u>26/01</u>
- <u>Air Conditioning, 1.9L Engine-Turbo Diesel Fuel Injection (DFI)/55kW, code AAZ, from August 1994</u>	<u>05/01</u>
- <u>Anti-lock brake system (ABS) with electronic differential lock (EDL), from August 1994</u>	<u>13/01</u>
- <u>Automatic transmission, from August 1994</u>	<u>19/01</u>
- <u>Automatic transmission, 2.8L Engine - Motronic Multiport Fuel Injection (MFI)/128kW, code AAA, from January 1995</u>	<u>27/01</u>
- <u>Automatic transmission, 2.0L Engine - Motronic Multiport Fuel Injection (MFI)/85kW, code ABA, from January 1995</u>	<u>27/01</u>
- <u>Central locking system and anti-theft alarm system, from August 1994</u>	<u>15/01</u>
- <u>Coolant fan, three speeds, 450W, code AAZ, from August 1994</u>	<u>22/01</u>
- <u>Coolant fan, three speeds, 450W, code AAA, from August 1994</u>	<u>21/01</u>
- <u>Coolant fan, two speeds, 250W, code AAA, from August 1994</u>	<u>03/01</u>
- <u>Coolant fan, two speeds, 250W, code AAZ, from August 1994</u>	<u>04/01</u>
- <u>Cruise control, from August 1994</u>	<u>14/01</u>
- <u>Daytime running lights only Canada, from August 1994</u>	<u>23/01</u>
- <u>Dual horns, from August 1995</u>	<u>01/15</u>
- <u>Front and rear power windows, from August 1994</u>	<u>07/01</u>
- <u>Heated seats, from August 1994</u>	<u>08/01</u>
- <u>Heated power mirrors, from August 1994</u>	<u>10/01</u>
- <u>Heated washer nozzles, from August 1994</u>	<u>11/01</u>
- <u>Interior light with delay switch, rear reading lights, make-up mirror lights from August 1994</u>	<u>09/01</u>
- <u>Power sunroof, from August 1994</u>	<u>16/01</u>
- <u>Rear window wiper/washer system, from August 1994</u>	<u>01/17</u>
- <u>Stereo radio with CD-changer and eight speakers, from August 1994</u>	<u>20/01</u>
- <u>Trunk lid release, sedan only, from August 1994</u>	<u>12/01</u>

Passat – Standard Equipment,

from August 1994

Relay location

For relay location and multiple connectors see also section "component locations".

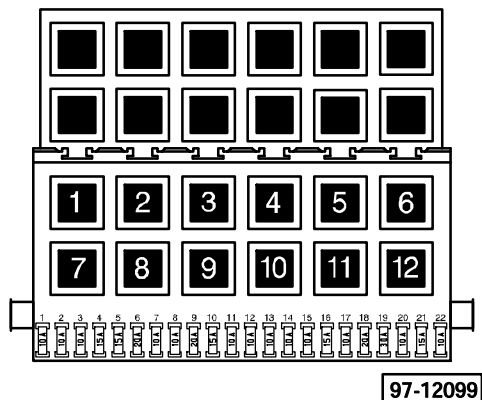

- 2** – Rear Window Wiper/Washer Relay (72)
- 4** – Load Reduction Relay (18)
- 6** – Emergency Flasher Relay (21)
- 8** – Washer/Wiper Intermittent Relay (19, 99)
- 9** – Warning Buzzer for Parking Light and Radio (36)
- 11** – Dual Horn Relay (53)
- Seat Belt Warning System Relay (4)

Note: Number in parentheses indicates production control number stamped on relay housing.

Fuse colors

- 30A – green
- 25A – white
- 20A – yellow
- 15A – blue
- 10A – red

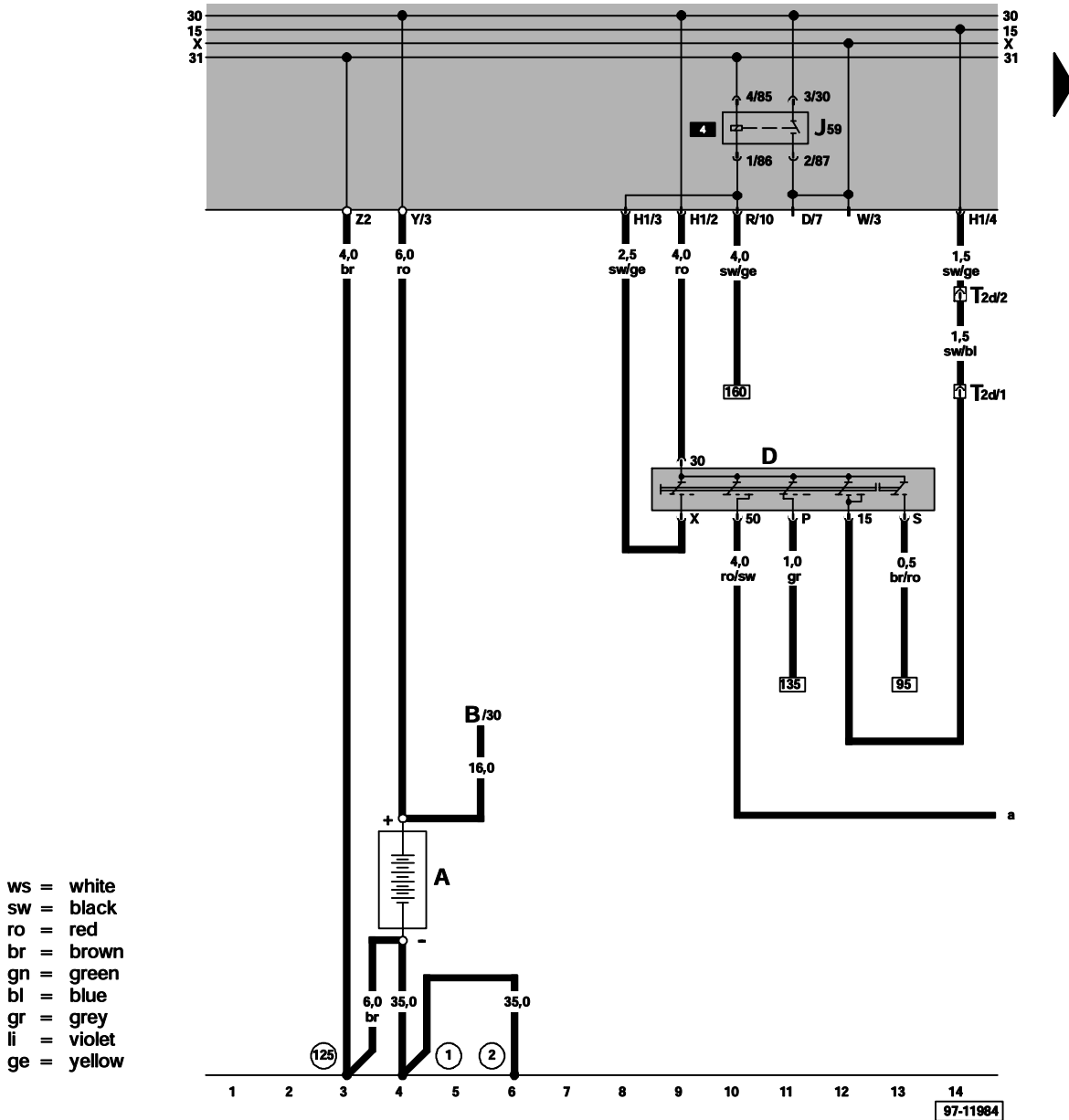

- ws = white
- sw = black
- ro = red
- br = brown
- gn = green
- bl = blue
- gr = grey
- li = violet
- ge = yellow

- A - Battery
- B - Starter
- D - Ignition/Starter Switch
- J59 - Load Reduction Relay
- T2d - Double Connector, behind fuse/relay panel

- (1) - Ground strap, battery to body
- (2) - Ground strap, transmission to body
- (125) - Ground connection -3-, in headlight wiring harness

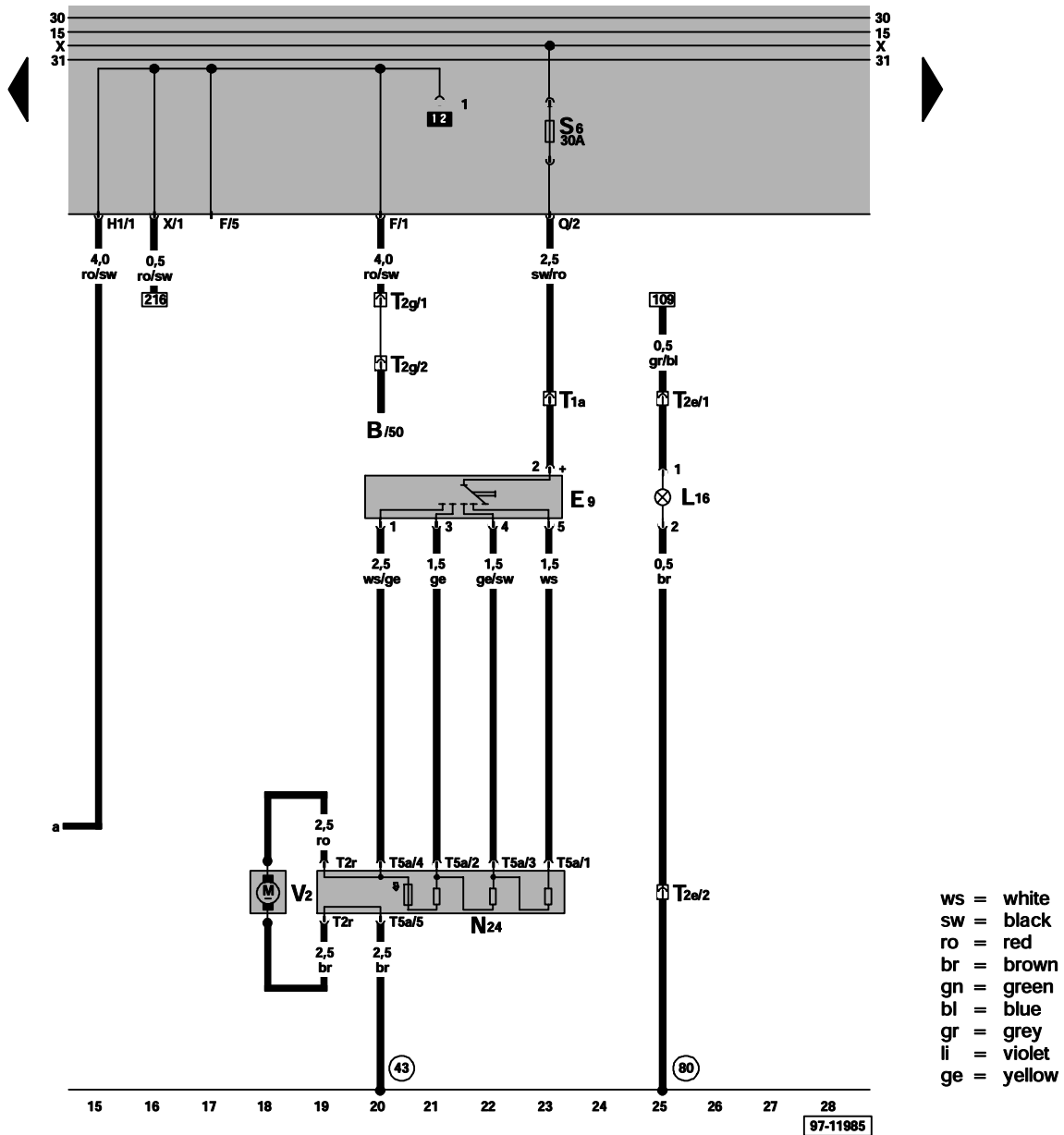

- B – Starter
- E9 – Fresh Air Blower Switch
- L16 – Fresh Air Control Lever Light
- N24 – Fresh Air Blower Series Resistance With Fuse
- T1a – Single Connector, behind instrument panel, center
- T2e – Double Connector, behind instrument panel, center
- T2g – Double Connector, behind fuse/relay panel
- T2r – Double Connector
- T5 – 5-Pin Connector
- V2 – Fresh Air Blower

- (43) – Ground connection, on right A-pillar, lower part
- (80) – Ground connection – 1 –, in instrument panel wiring harness

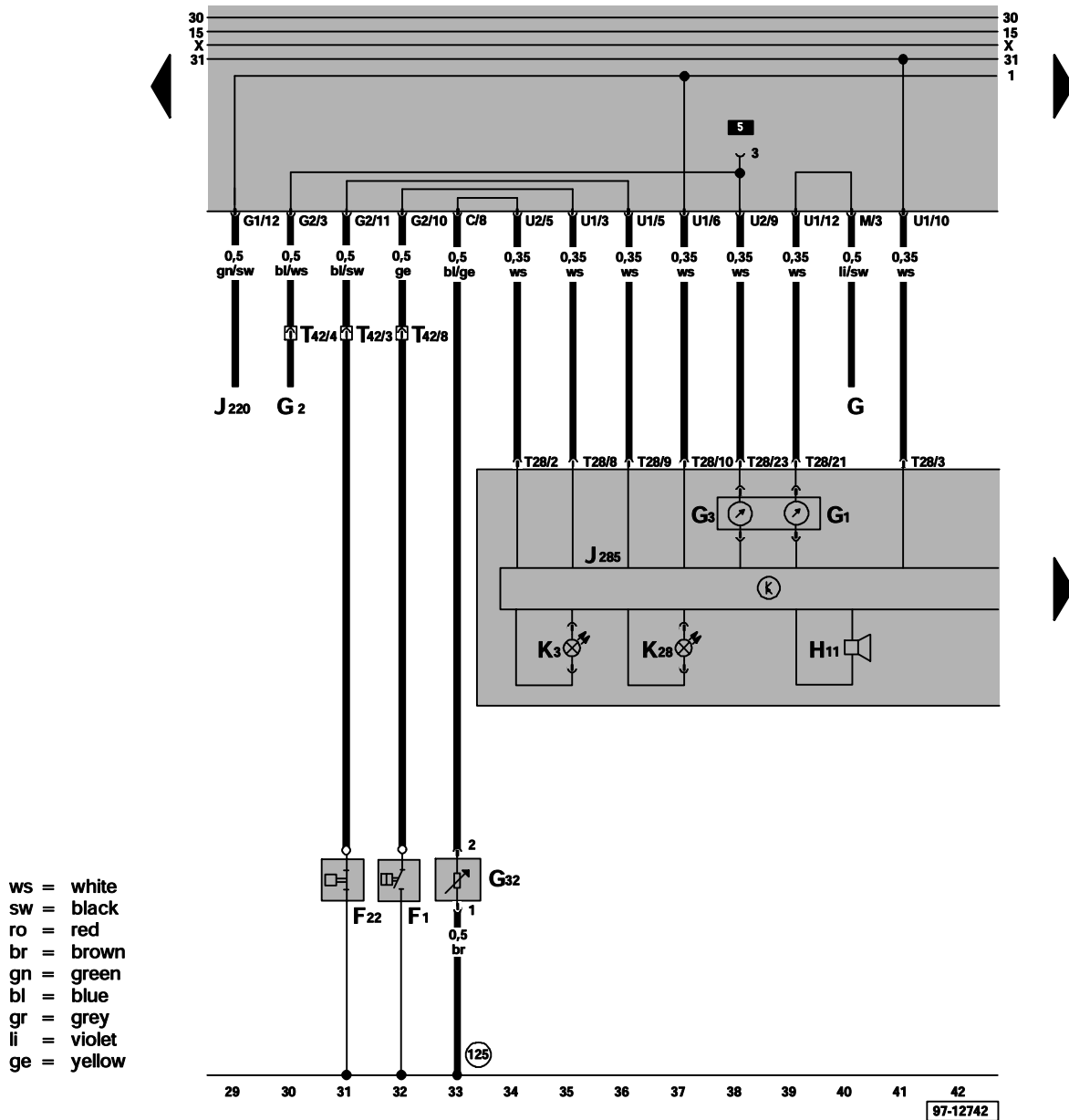

- F1 – Oil Pressure Switch *
- F22 – 0.3 Bar Oil Pressure Switch
- G – Fuel Level Sensor
- G1 – Fuel Gauge
- G2 – Engine Coolant Temperature (ECT) Sensor
- G3 – Engine Coolant Temperature (ECT) Gauge
- G32 – Engine Coolant Level (ECL) Sensor
- H11 – Oil Pressure Warning Buzzer
- J220 – Motronic Engine Control Module (ECM)
- J285 – Control Module With Display Unit In Instrument Cluster
- K3 – Oil Pressure Warning Light
- K28 – Engine Coolant Level/Temperature (ECL/ECT) Warning Light
- T28 – 28-Pin Connector, on instrument cluster
- T42 – 42-Pin Connector, on left cylinder head

(125) – Ground connection –3–, in headlight wiring harness

* – Switch levels see Repair Manual Passat 1994 " Engine

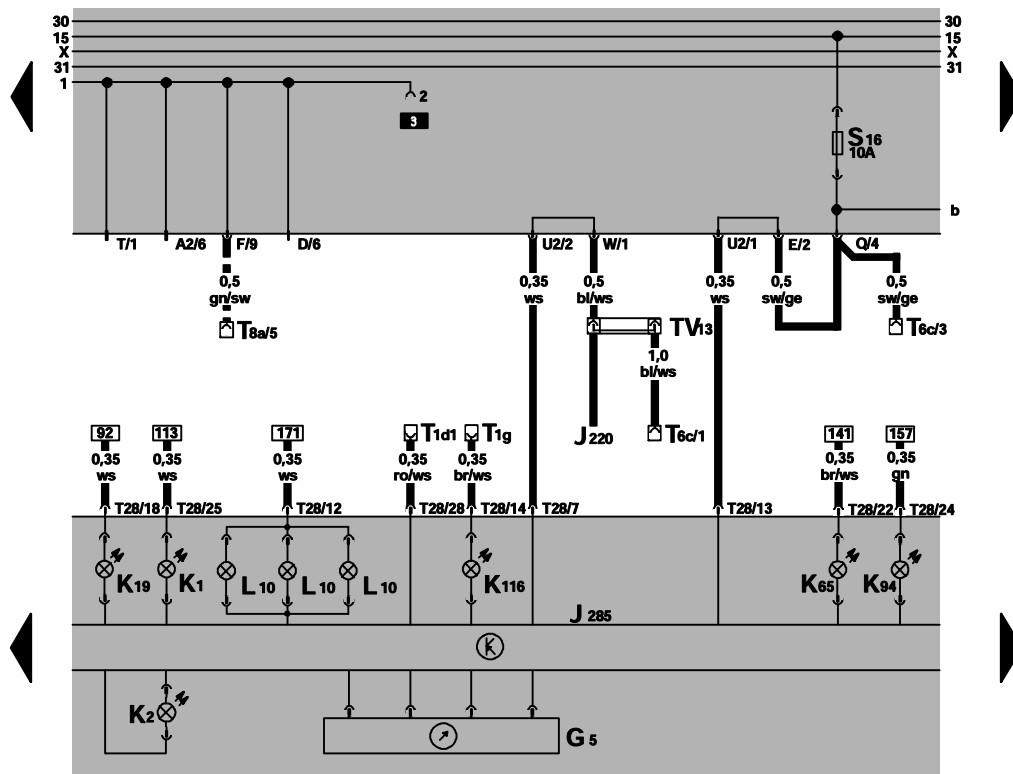

ws = white
 sw = black
 ro = red
 br = brown
 gn = green
 bl = blue
 gr = grey
 li = violet
 ge = yellow

43 44 45 46 47 48 49 50 51 52 53 54 55 56
 97-12743

- G5 – Tachometer
- J220 – Motronic Engine Control Module (ECM)
- J285 – Control Module With Display Unit In Instrument Cluster
- K1 – Headlight High Beam Indicator Light
- K2 – Generator (GEN) Warning Light
- K19 – Seat Belt Warning Light
- K65 – Left Turn Signal Indicator Light
- K94 – Right Turn Signal Indicator Light
- K116 – Warning Light For Rear Lid Unlocked, sedan only
- L10 – Instrument Cluster Light
- T1d – Single Connector, behind fuse/relay panel
- T1g – Single Connector, behind fuse/relay panel
- T6c – 6-Pin Connector, behind fuse/relay panel
- T8a – 8-Pin Connector, behind fuse/relay panel
- T28 – 28-Pin Connector, on instrument cluster
- TV13 – Vehicle Speed Signal Wire Connector, above fuse/relay panel
- ■ – Automatic transmission only

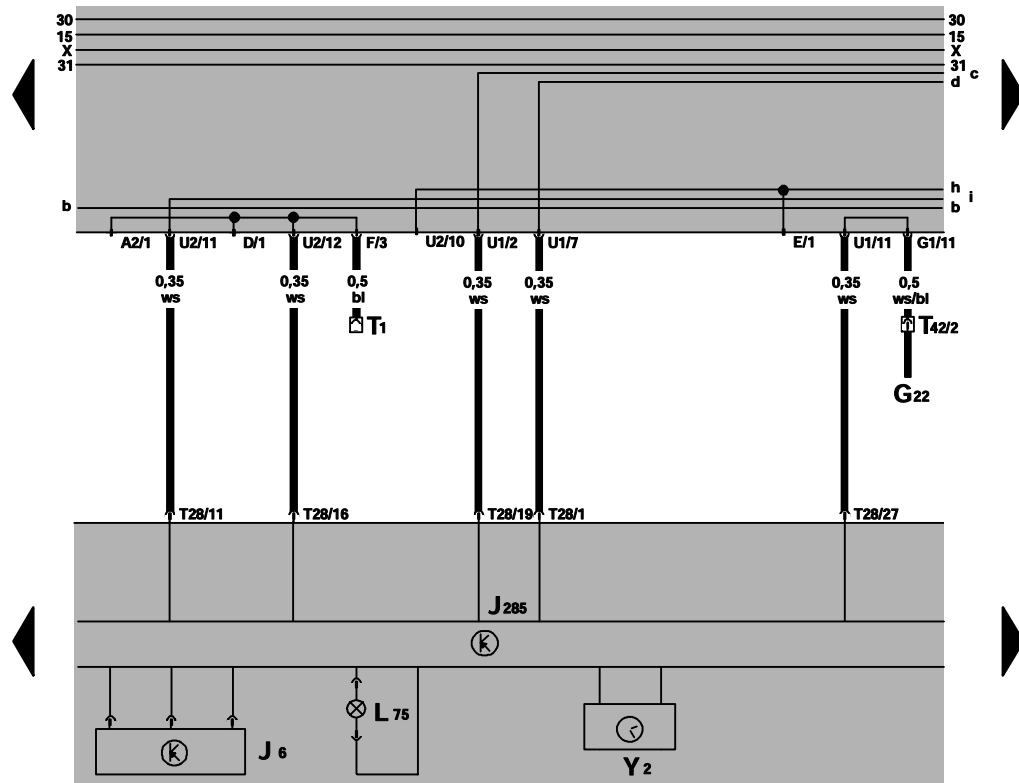

- ws = white
- sw = black
- ro = red
- br = brown
- gn = green
- bl = blue
- gr = grey
- li = violet
- ge = yellow

57 58 59 60 61 62 63 64 65 66 67 68 69 70
97-12744

- G22 – Speedometer Vehicle Speed Sensor (VSS) (hall generator, on transmission)
- J6 – Voltage Stabilizer
- J285 – Control Module With Display Unit In Instrument Cluster
- L75 – Digital Display Light
- T1 – Single Connector, near starter
- T28 – 28-Pin Connector, on instrument cluster
- T42 – 42-Pin Connector, on left cylinder head
- Y2 – Digital clock

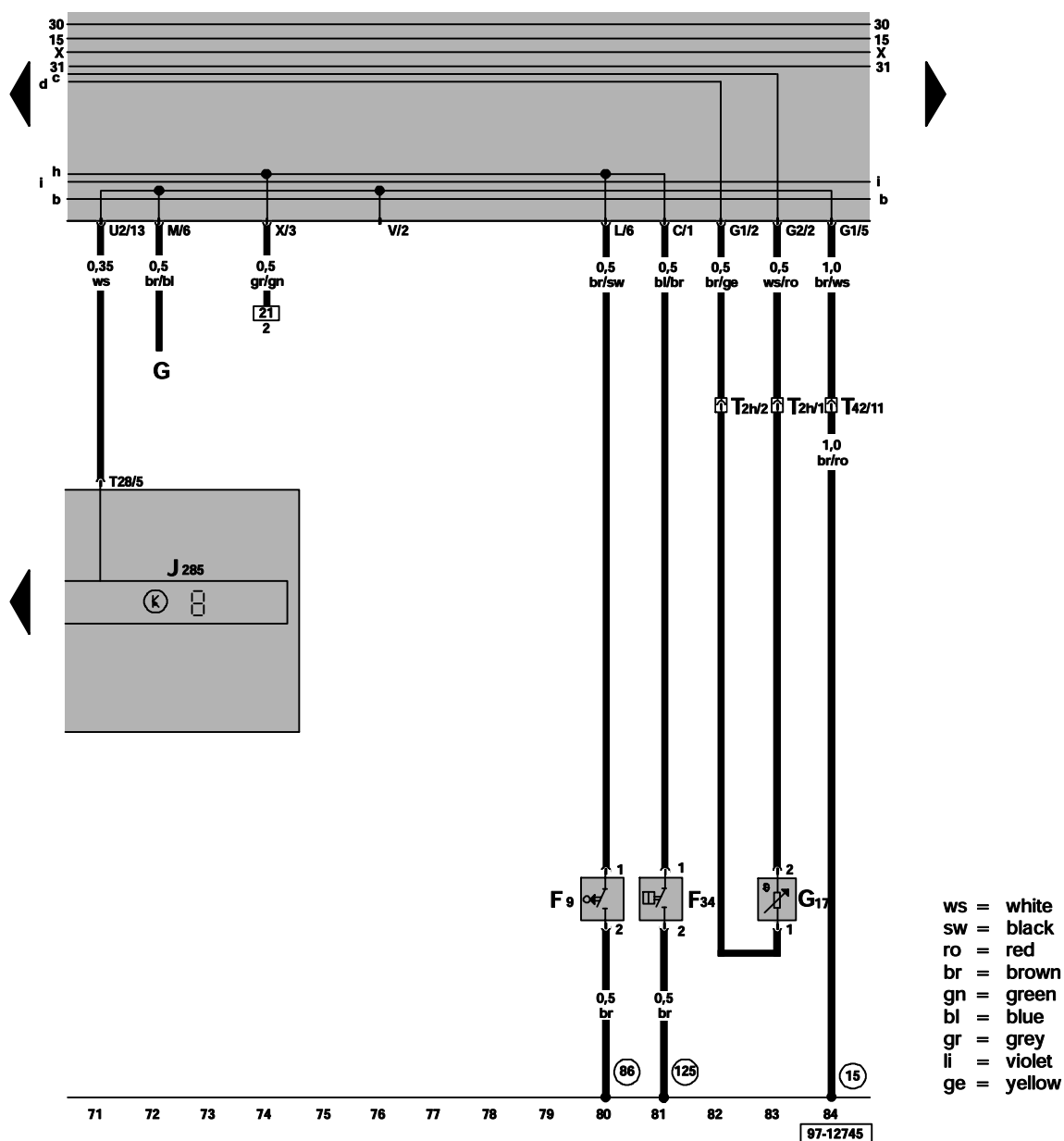

- F9 - Parking Brake Warning Light Switch
- F34 - Brake Fluid Level Warning Switch
- G - Fuel Level Sensor
- G17 - Outside Air Temperature Sensor
- J285 - Control Module With Display Unit In Instrument Cluster
- T2 - Double Connector, in engine compartment, right front
- T28 - 28-Pin Connector, on instrument cluster
- T42 - 42-Pin Connector, on left cylinder head
- (15) - Ground connection, on cylinder head
- (86) - Ground connection - 1-, in rear wiring harness

(125) - Ground connection - 3-, in headlight wiring harness