

## FOREWORD

This wiring diagram manual has been prepared to provide information on the electrical system of the 2004 LAND CRUISER.

Applicable models: UZJ100 Series

For service specifications and repair procedures of the above models other than those listed in this manual, refer to the following manuals;

Manual Name	Pub. No.
▲ 2004 LAND CRUISER Repair Manual Volume 1	RM1071U1
Volume 2	RM1071U2
▲ 2004 TOYOTA New Car Features	NCF257U

All information in this manual is based on the latest product information at the time of publication. However, specifications and procedures are subject to change without notice.

**TOYOTA MOTOR CORPORATION**

### NOTICE

When handling supplemental restraint system components (removal, installation or inspection, etc.), always follow the direction given in the repair manuals listed above to prevent accidents and supplemental restraint system malfunction.

# 2004 LAND CRUISER ELECTRICAL WIRING DIAGRAM

	Section Code	Page
INTRODUCTION .....	A .....	2
HOW TO USE THIS MANUAL .....	B .....	3
TROUBLESHOOTING .....	C .....	12
ABBREVIATIONS .....	D .....	17
GLOSSARY OF TERMS AND SYMBOLS .....	E .....	18
RELAY LOCATIONS .....	F .....	20
ELECTRICAL WIRING ROUTING .....	G .....	68
SYSTEM CIRCUITS .....	H .....	93
GROUND POINT .....	I .....	376
POWER SOURCE (Current Flow Chart) .....	J .....	384
CONNECTOR LIST .....	K .....	394
PART NUMBER OF CONNECTORS .....	L .....	406
OVERALL ELECTRICAL WIRING DIAGRAM .	M .....	410

**▲2003 TOYOTA MOTOR CORPORATION**

All rights reserved. This book may not be reproduced or copied, in whole or in part, without the written permission of Toyota Motor Corporation.

# A INTRODUCTION

This manual consists of the following 13 sections:

No.	Section	Description
A	INDEX	Index of the contents of this manual.
	INTRODUCTION	Brief explanation of each section.
B	HOW TO USE THIS MANUAL	Instructions on how to use this manual.
C	TROUBLE-SHOOTING	Describes the basic inspection procedures for electrical circuits.
D	ABBREVIATIONS	Defines the abbreviations used in this manual.
E	GLOSSARY OF TERMS AND SYMBOLS	Defines the symbols and functions of major parts.
F	RELAY LOCATIONS	Shows position of the Electronic Control Unit, Relays, Relay Block, etc. This section is closely related to the system circuit.
G	ELECTRICAL WIRING ROUTING	Describes position of Parts Connectors, Splice points, Ground points, etc. This section is closely related to the system circuit.
H	INDEX	Index of the system circuits.
	SYSTEM CIRCUITS	Electrical circuits of each system are shown from the power supply through ground points. Wiring connections and their positions are shown and classified by code according to the connection method. (Refer to the section, "How to use this manual"). The "System Outline" and "Service Hints" useful for troubleshooting are also contained in this section.
I	GROUND POINT	Shows ground positions of all parts described in this manual.
J	POWER SOURCE (Current Flow Chart)	Describes power distribution from the power supply to various electrical loads.
K	CONNECTOR LIST	Describes the form of the connectors for the parts appeared in this book. This section is closely related to the system circuit.
L	PART NUMBER OF CONNECTORS	Indicates the part number of the connectors used in this manual.
M	OVERALL ELECTRICAL WIRING DIAGRAM	Provides circuit diagrams showing the circuit connections.

This manual provides information on the electrical circuits installed on vehicles by dividing them into a circuit for each system.

The actual wiring of each system circuit is shown from the point where the power source is received from the battery as far as each ground point. (All circuit diagrams are shown with the switches in the OFF position.)

When troubleshooting any problem, first understand the operation of the circuit where the problem was detected (see System Circuit section), the power source supplying power to that circuit (see Power Source section), and the ground points (see Ground Point section). See the System Outline to understand the circuit operation.

When the circuit operation is understood, begin troubleshooting of the problem circuit to isolate the cause. Use Relay Location and Electrical Wiring Routing sections to find each part, junction block and wiring harness connectors, wiring harness and wiring harness connectors, splice points, and ground points of each system circuit. Internal wiring for each junction block is also provided for better understanding of connection within a junction block.

Wiring related to each system is indicated in each system circuit by arrows (from\_\_, to\_\_). When overall connections are required, see the Overall Electrical Wiring Diagram at the end of this manual.

# B HOW TO USE THIS MANUAL

\* The system shown here is an EXAMPLE ONLY. It is different to the actual circuit shown in the SYSTEM CIRCUITS SECTION.

## [A] Stop Light

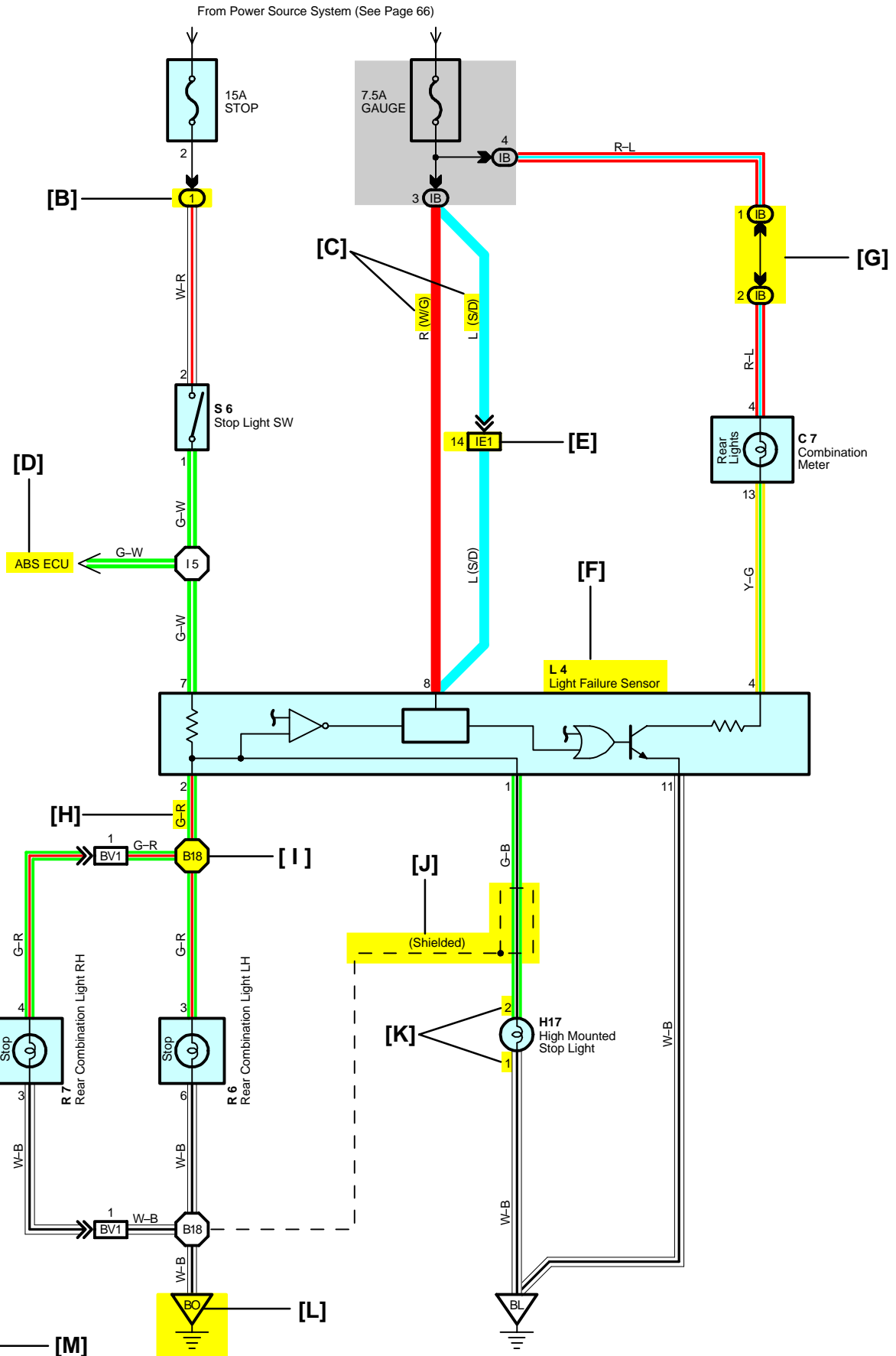

**[A]** : System Title

**[B]** : Indicates a Relay Block. No shading is used and only the Relay Block No. is shown to distinguish it from the J/B

Example: ① Indicates Relay Block No.1

**[C]** : ( ) is used to indicate different wiring and connector, etc. when the vehicle model, engine type, or specification is different.

**[D]** : Indicates related system.

**[E]** : Indicates the wiring harness and wiring harness connector. The wiring harness with male terminal is shown with arrows (↘). Outside numerals are pin numbers.

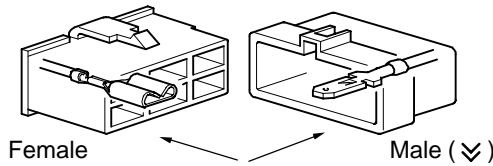

The first letter of the code for each wiring harness and wiring harness connector(s) indicates the component's location, e.g, "E" for the Engine Compartment, "I" for the Instrument Panel and Surrounding area, and "B" for the Body and Surrounding area.

When more than one code has the first and second letters in common, followed by numbers (e.g, IH1, IH2), this indicates the same type of wiring harness and wiring harness connector.

**[F]** : Represents a part (all parts are shown in sky blue). The code is the same as the code used in parts position.

**[G]** : Junction Block (The number in the circle is the J/B No. and the connector code is shown beside it). Junction Blocks are shaded to clearly separate them from other parts.

Example:

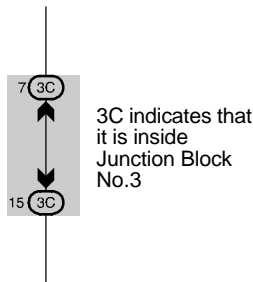

**[H]** : Indicates the wiring color.

Wire colors are indicated by an alphabetical code.

- B = Black    W = White    BR = Brown
- L = Blue    V = Violet    SB = Sky Blue
- R = Red    G = Green    LG = Light Green
- P = Pink    Y = Yellow    GR = Gray
- O = Orange

The first letter indicates the basic wire color and the second letter indicates the color of the stripe.

Example: L - Y

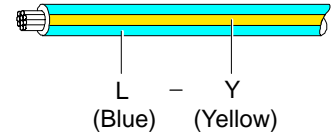

**[I]** : Indicates a wiring Splice Point (Codes are "E" for the Engine Room, "I" for the Instrument Panel, and "B" for the Body).

Example:

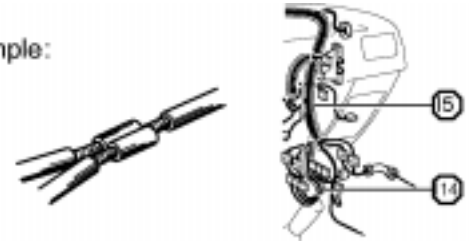

The Location of splice Point I 5 is indicated by the shaded section.

**[J]** : Indicates a shielded cable.



**[K]** : Indicates the pin number of the connector. The numbering system is different for female and male connectors.

Example: Numbered in order from upper left to lower right

Numbered in order from upper right to lower left

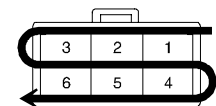
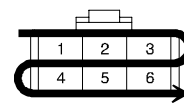

Female

Male

**[L]** : Indicates a ground point.

The first letter of the code for each ground point(s) indicates the component's location, e.g, "E" for the Engine Compartment, "I" for the Instrument Panel and Surrounding area, and "B" for the Body and Surrounding area.

**[M]** : Page No.

## B HOW TO USE THIS MANUAL

### [N] System Outline

Current is applied at all times through the STOP fuse to TERMINAL 2 of the stop light SW.  
When the ignition SW is turned on, current flows from the GAUGE fuse to TERMINAL 8 of the light failure sensor, and also flows through the rear lights warning light to TERMINAL 4 of the light failure sensor.

#### Stop Light Disconnection Warning

When the ignition SW is turned on and the brake pedal is pressed (Stop light SW on), if the stop light circuit is open, the current flowing from TERMINAL 7 of the light failure sensor to TERMINALS 1, 2 changes, so the light failure sensor detects the disconnection and the warning circuit of the light failure sensor is activated.

As a result, the current flows from TERMINAL 4 of the light failure sensor to TERMINAL 11 to GROUND and turns the rear lights warning light on. By pressing the brake pedal, the current flowing to TERMINAL 8 of the light failure sensor keeps the warning circuit on and holds the warning light on until the ignition SW is turned off.

### [O] Service Hints

#### S6 Stop Light SW

2-1 : Closed with the brake pedal depressed

#### L4 Light Failure Sensor

1, 2, 7-Ground : Approx. 12 volts with the stop light SW on

4, 8-Ground : Approx. 12 volts with the ignition SW at ON position

11-Ground : Always continuity

### [P] : Parts Location

Code	See Page	Code	See Page	Code	See Page
C7	34	L4	36	R7	37
H17	36	R6	37	S6	35

### [Q] : Relay Blocks

Code	See Page	Relay Blocks (Relay Block Location)
1	18	R/B No.1 (Instrument Panel Brace LH)

### [R] : Junction Block and Wire Harness Connector

Code	See Page	Junction Block and Wire Harness (Connector Location)
IB	20	Instrument Panel Wire and Instrument Panel J/B (Lower Finish Panel)
3C	22	Instrument Panel Wire and J/B No.3 (Instrument Panel Brace LH)

### [S] : Connector Joining Wire Harness and Wire Harness

Code	See Page	Joining Wire Harness and Wire Harness (Connector Location)
IE1	42	Floor Wire and Instrument Panel Wire (Left Kick Panel)
BV1	50	Luggage Room Wire and Floor Wire (Luggage Room Left)

### [T] : Ground Points

Code	See Page	Ground Points Location
BL	50	Under the Left Center Pillar
BO	50	Back Panel Center

### [U] : Splice Points

Code	See Page	Wire Harness with Splice Points	Code	See Page	Wire Harness with Splice Points
I5	44	Cowl Wire	B18	50	Luggage Room Wire

**[N]** : Explains the system outline.

**[O]** : Indicates values or explains the function for reference during troubleshooting.

**[P]** : Indicates the reference page showing the position on the vehicle of the parts in the system circuit.

Example : Part "L4" (Light Failure Sensor) is on page 36 of the manual.

\* The letter in the code is from the first letter of the part, and the number indicates its order in parts starting with that letter.

Example : L 4  
  
Parts is 4th in order  
Light Failure Sensor

**[Q]** : Indicates the reference page showing the position on the vehicle of Relay Block Connectors in the system circuit.

Example : Connector "1" is described on page 18 of this manual and is installed on the left side of the instrument panel.

**[R]** : Indicates the reference page showing the position on the vehicle of J/B and Wire Harness in the system circuit.

Example : Connector "3C" connects the Instrument Panel Wire and J/B No.3. It is described on page 22 of this manual, and is installed on the instrument panel left side.

**[S]** : Indicates the reference page describing the wiring harness and wiring harness connector (the female wiring harness is shown first, followed by the male wiring harness).

Example : Connector "IE1" connects the floor wire (female) and Instrument panel wire (male). It is described on page 42 of this manual, and is installed on the left side kick panel.

**[T]** : Indicates the reference page showing the position of the ground points on the vehicle.

Example : Ground point "BO" is described on page 50 of this manual and is installed on the back panel center.

**[U]** : Indicates the reference page showing the position of the splice points on the vehicle.

Example : Splice point "I5" is on the Cowl Wire Harness and is described on page 44 of this manual.



# B HOW TO USE THIS MANUAL

The ground points circuit diagram shows the connections from all major parts to the respective ground points. When troubleshooting a faulty ground point, checking the system circuits which use a common ground may help you identify the problem ground quickly. The relationship between ground points (  $\nabla_{EA}$ ,  $\nabla_{IB}$  and  $\nabla_{IC}$  shown below) can also be checked this way.

## I GROUND POINT

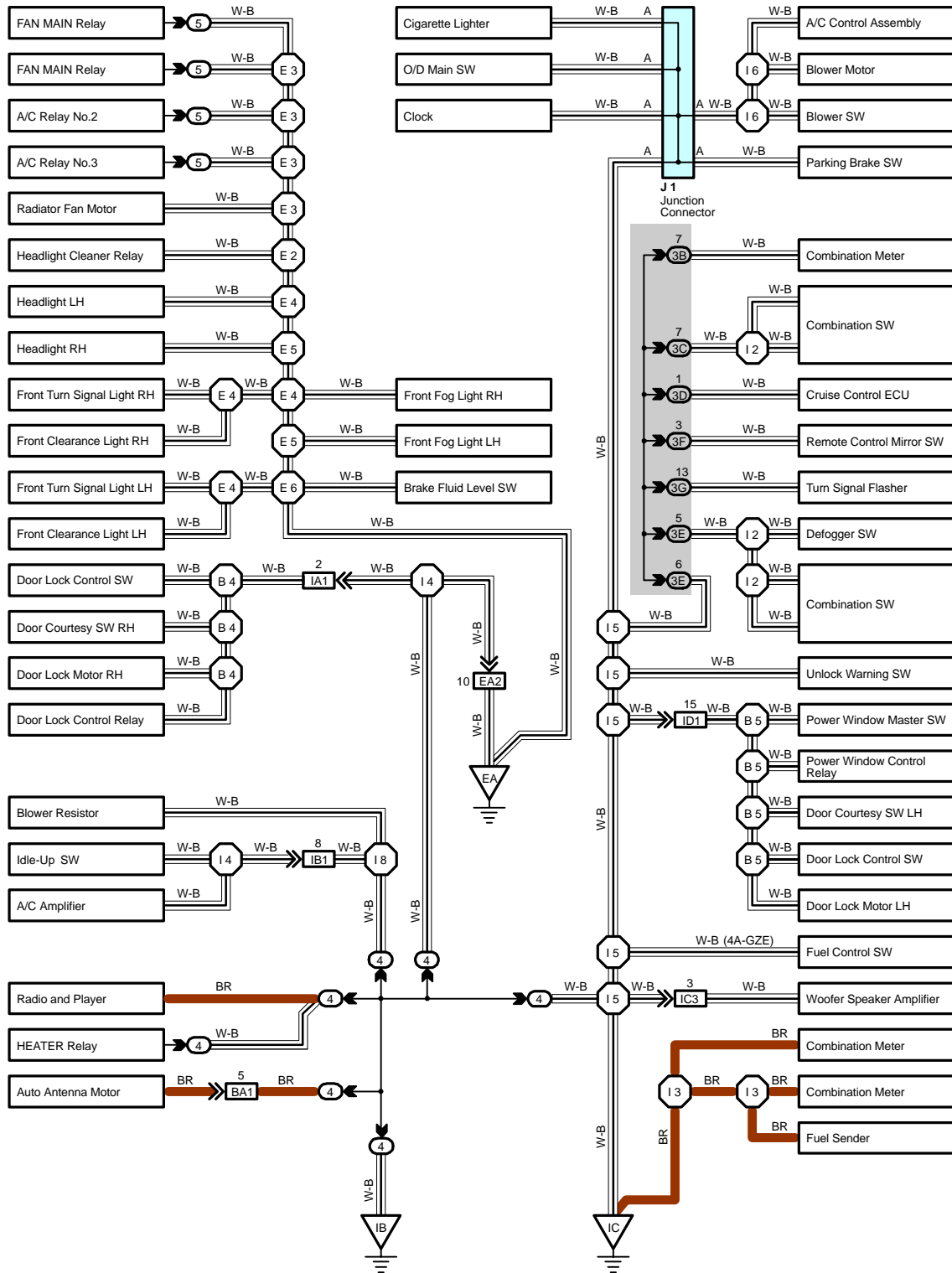

\* The system shown here is an EXAMPLE ONLY. It is different to the actual circuit shown in the SYSTEM CIRCUITS SECTION.

The "Current Flow Chart" section, describes which parts each power source (fuses, fusible links, and circuit breakers) transmits current to. In the Power Source circuit diagram, the conditions when battery power is supplied to each system are explained. Since all System Circuit diagrams start from the power source, the power source system must be fully understood.

### J POWER SOURCE (Current Flow Chart)

The chart below shows the route by which current flows from the battery to each electrical source (Fusible Link, Circuit Breaker, Fuse, etc.) and other parts.

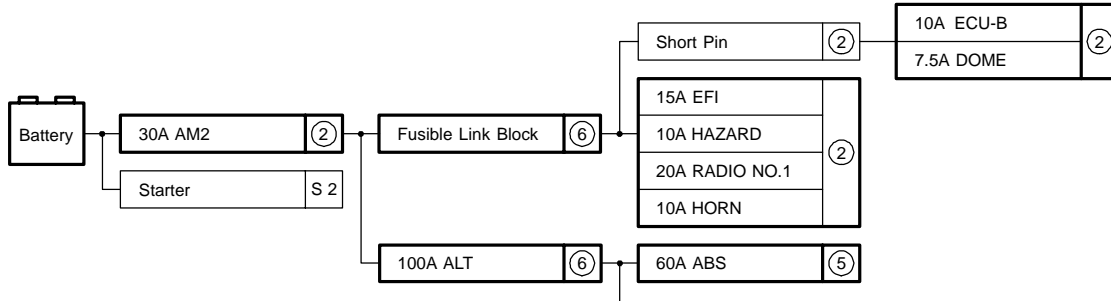

### Engine Room R/B (See Page 20)

Fuse	System	Page
20A STOP	ABS	194
	ABS and Traction Control	187
	Cruise Control	180
	Electronically Controlled Transmission	166
	Multiplex Communication System	210
10A DOME	Cigarette Lighter	214
	Combination Meter	230
	Headlight	112
	Interior Light	122
	Key Reminder and Seat Belt Warning	
	Light Auto Turn Off	

### Power Source

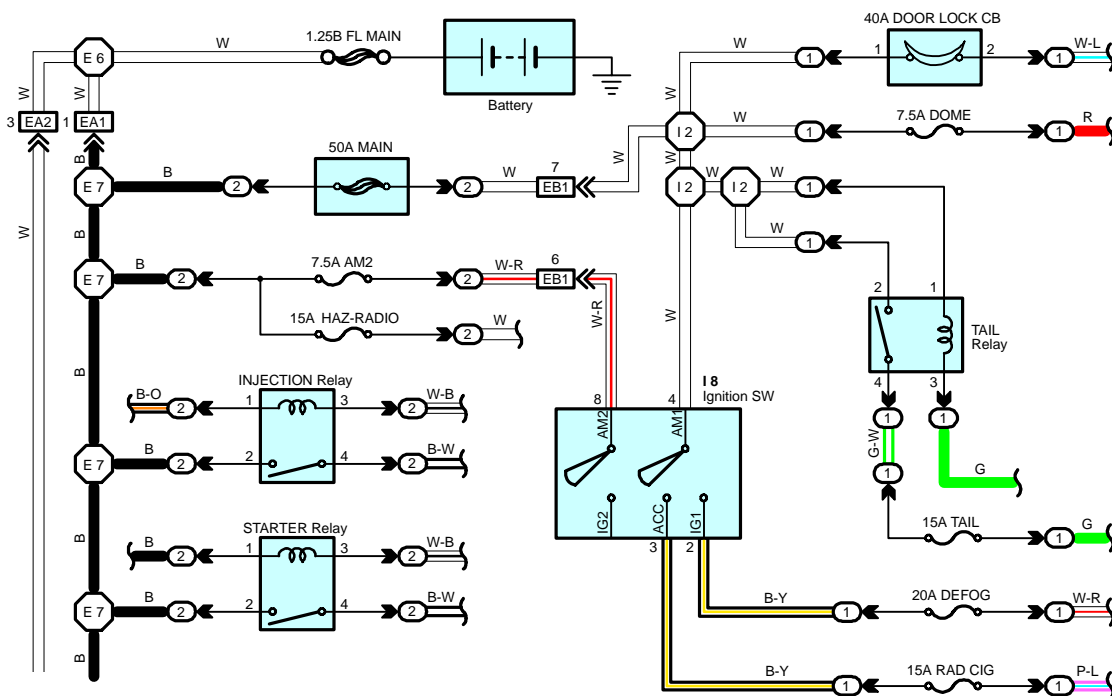

\* The system shown here is an EXAMPLE ONLY. It is different to the actual circuit shown in the SYSTEM CIRCUITS SECTION.

# B HOW TO USE THIS MANUAL

## K CONNECTOR LIST

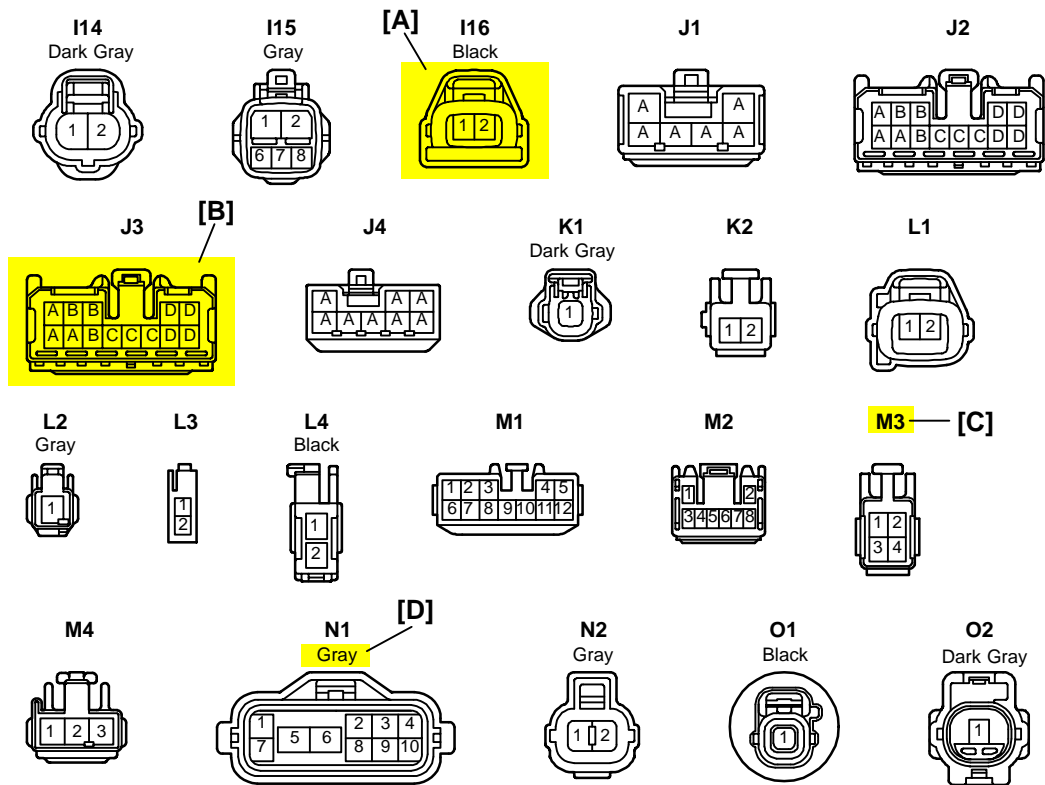

**[A]** : Indicates connector to be connected to a part. (The numeral indicates the pin No.)

**[B]** : Junction Connector  
Indicates a connector which is connected to a short terminal.

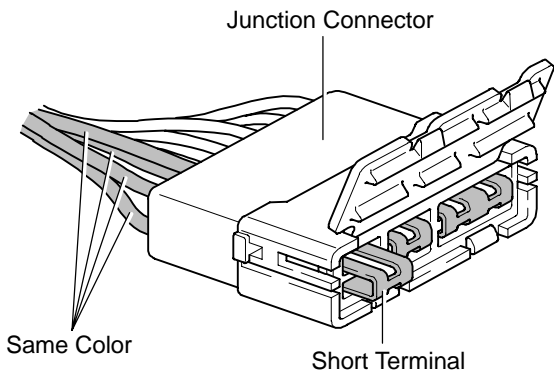

Junction connector in this manual include a short terminal which is connected to a number of wire harnesses. Always perform inspection with the short terminal installed. (When installing the wire harnesses, the harnesses can be connected to any position within the short terminal grouping. Accordingly, in other vehicles, the same position in the short terminal may be connected to a wire harness from a different part.)

Wire harness sharing the same short terminal grouping have the same color.

**[C]** : Parts Code  
The first letter of the code is taken from the first letter of part, and the numbers indicates its order in parts which start with the same letter.

**[D]** : Connector Color  
Connectors not indicated are milky white in color.

## L PART NUMBER OF CONNECTORS

Code	Part Name	Part Number	Code	Part Name	Part Number
A 1	A/C Ambient Temp. Sensor	90980-1 1070	D 4	Diode (Courtesy)	90980-1 1608
A 2	A/C Condenser Fan Motor	90980-1 1237	D 5	Diode (Interior Light)	90980-10962
A 3	A/C Condenser Fan Relay	90980-10940	D 6	Diode (Moon Roof)	90980-1 1608
A 4	A/C Condenser Fan Resistor	90980-10928	D 7	Door Lock Control Relay	90980-10848
A 5	A/C Magnetic Clutch	90980-1 1271	D 8	Door Lock Control SW LH	90980-1 1148
A 6	A/T Oil Temp. Sensor	90980-1 1413	D 9	Door Lock Control SW RH	
[A]	ABS Actuator [B]	909-1 151	D10	Door Courtesy SW LH	90980-1 1097
A 8	ABS Actuator	90980-1 1009	D11	Door Courtesy SW RH	
A 9	ABS Speed Sensor Front LH	90980-10941	D12	Door Courtesy SW Front LH	90980-1 1156
A10	ABS Speed Sensor Front RH	90980-1 1002	D13	Door Courtesy SW Front RH	
A11	Airbag Sensor Front LH	90980-1 1856	D14	Door Courtesy SW Rear LH	
A12	Airbag Sensor Front RH		D15	Door Courtesy SW Rear RH	
A13	Airbag Sensor Front LH	90980-1 1194	D16	Door Lock and Unlock SW LH	90980-1 1170
		90980-1 1194			

**[A]** : Part Code

**[B]** : Part Name

**[C]** : Part Number

Toyota Part Number are indicated.

Not all of the above part numbers of the connector are established for the supply.

**ABBREVIATIONS**

The following abbreviations are used in this manual.

A/C	=	Air Conditioning
A/T	=	Automatic Transmission
ABS	=	Anti-Lock Brake System
ACIS	=	Acoustic Control Induction System
BA	=	Brake Assist
DIFF.	=	Differential
DVD	=	Digital Versatile Disc
EC	=	Electrochromic
ECU	=	Electronic Control Unit
ESA	=	Electronic Spark Advance
ETCS-i	=	Electronic Throttle Control System-intelligent
EVAP	=	Evaporative Emission
IC	=	Integrated Circuit
J/B	=	Junction Block
LH	=	Left-Hand
R/B	=	Relay Block
RH	=	Right-Hand
SFI	=	Sequential Multiport Fuel Injection
SRS	=	Supplemental Restraint System
SW	=	Switch
TEMP.	=	Temperature
TRAC	=	Traction Control
VSC	=	Vehicle Stability Control
VSV	=	Vacuum Switching Valve
w/	=	With
w/o	=	Without

\* The titles given inside the components are the names of the terminals (terminal codes) and are not treated as being abbreviations.

# K CONNECTOR LIST

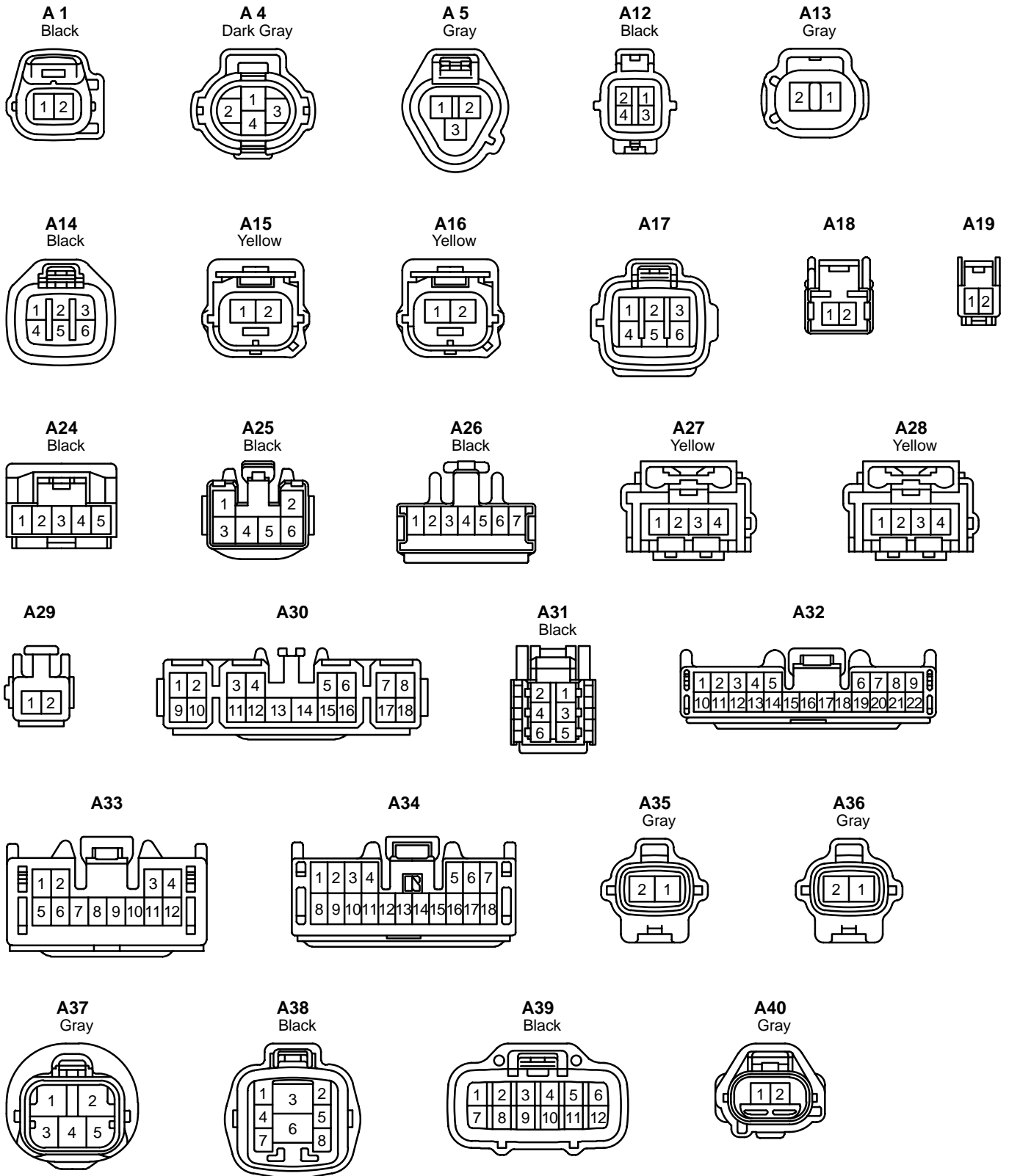

A41

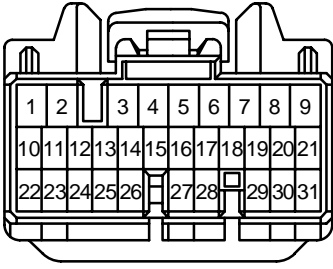

A42

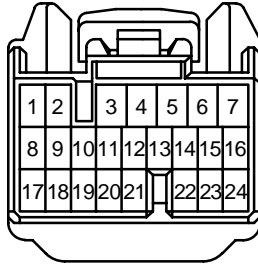

A43

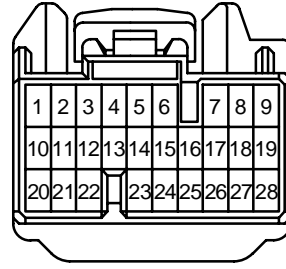

A44

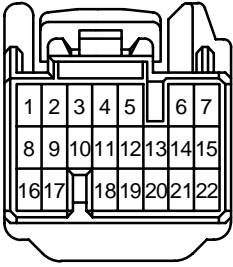

A45

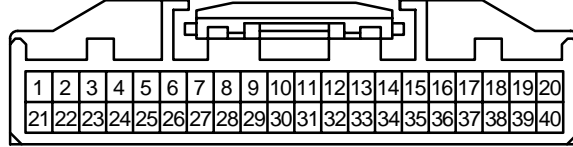

A46

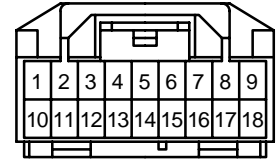

A47

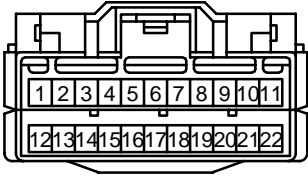

A48

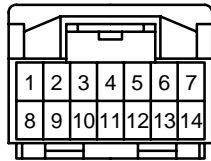

B 1  
Black

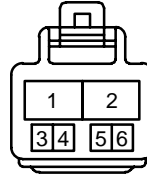

B 2



B 3

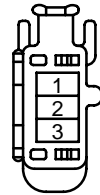

B 4  
Black



B 5



B 6  
Gray



B 7

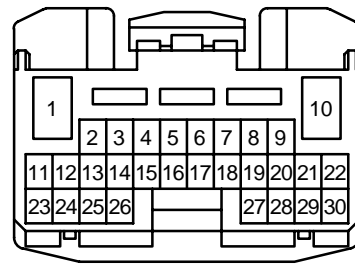

B 8

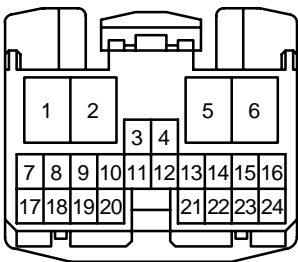

B 9

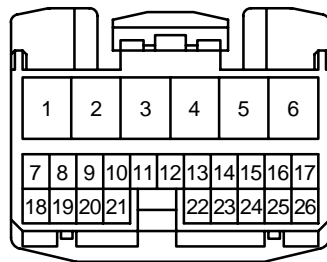

C 1  
Dark Gray



C 2  
Black

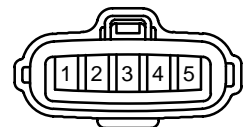

# K CONNECTOR LIST

\*1 : w/o Side Airbag

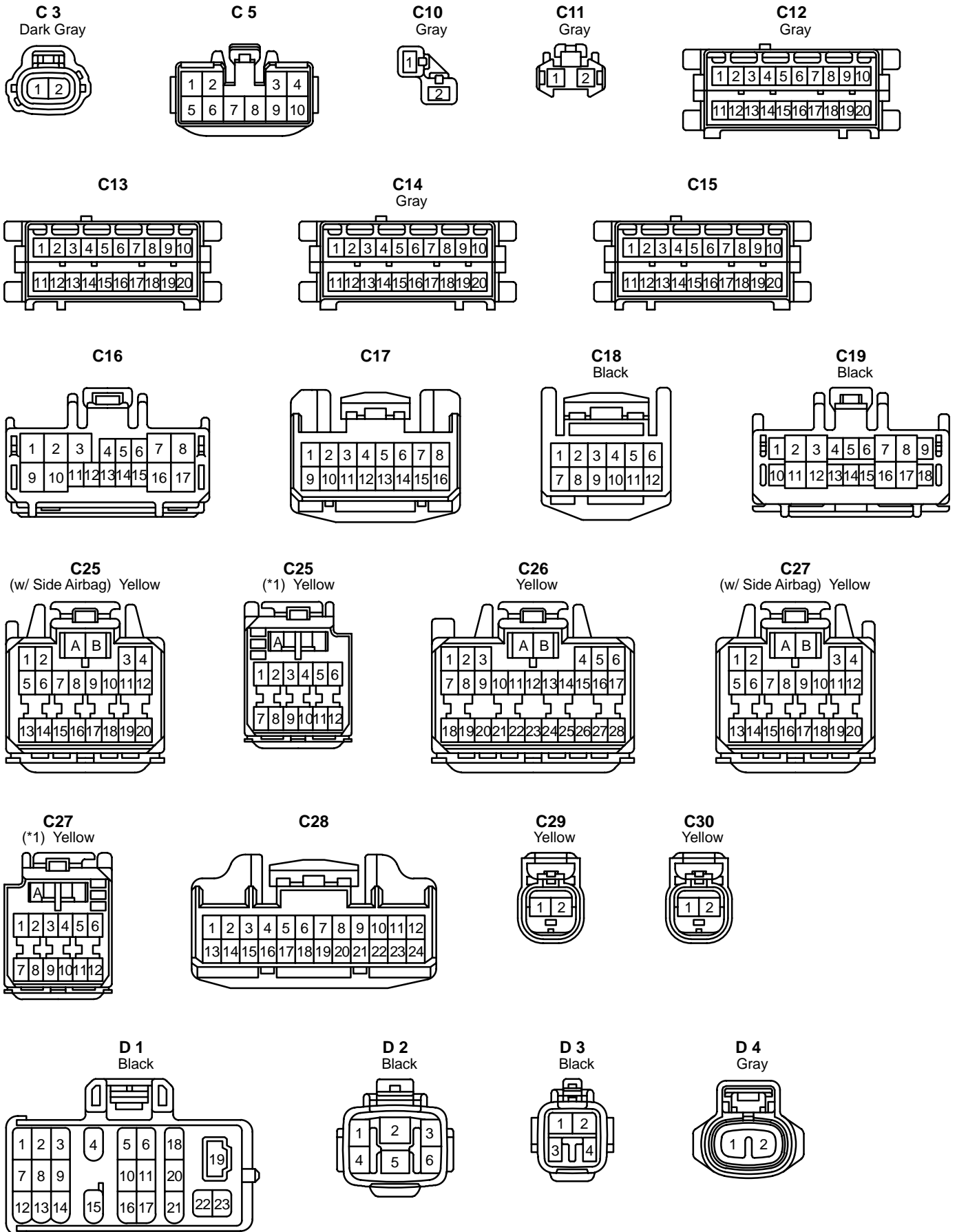



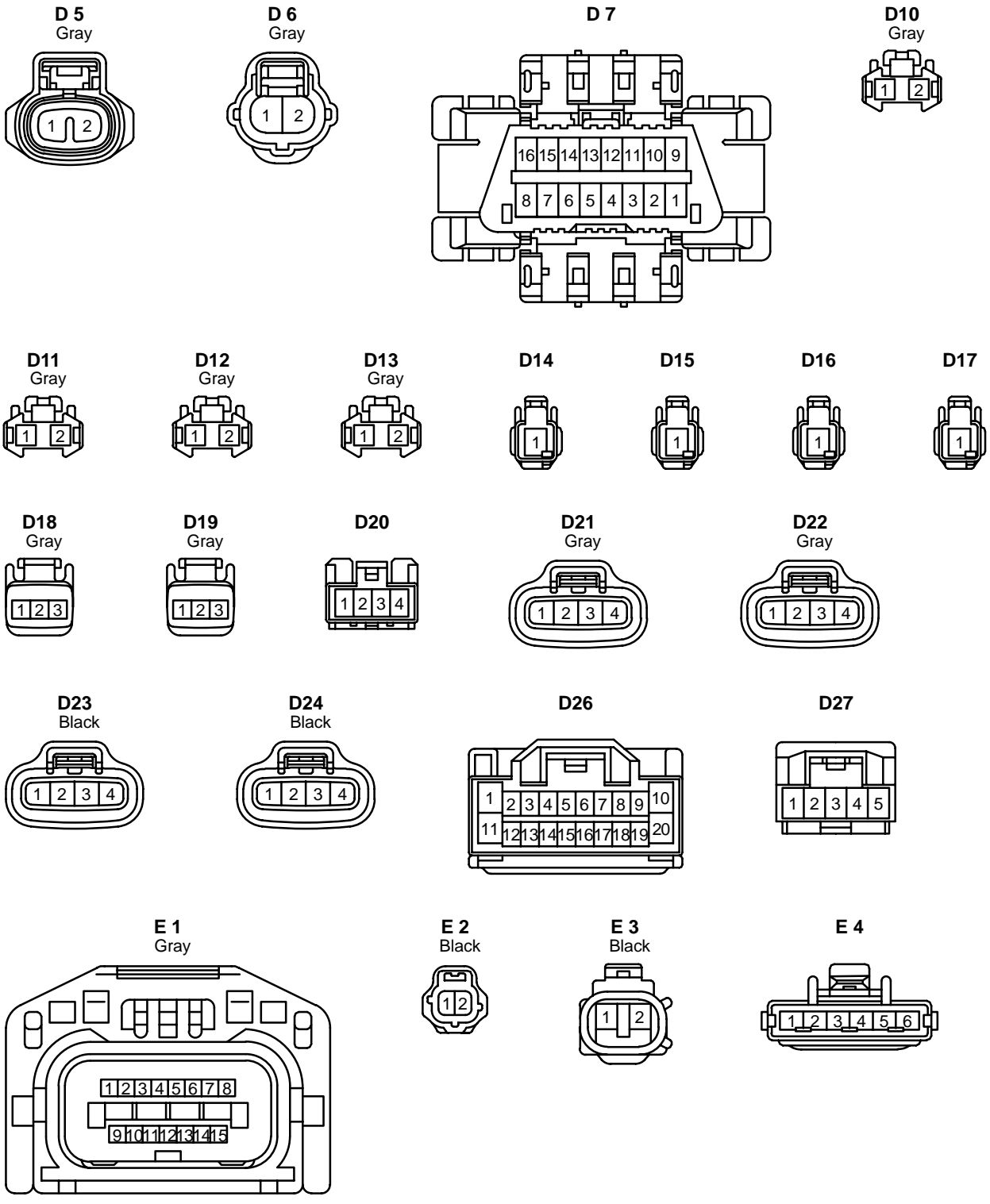

# K CONNECTOR LIST

**E 5**

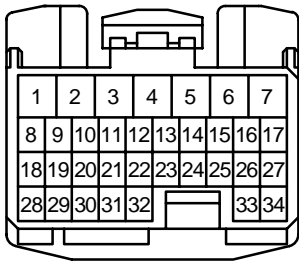

**E 6**

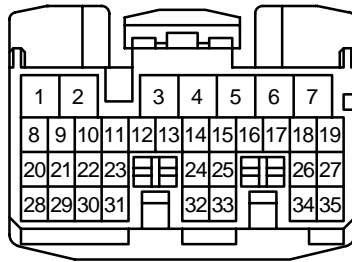

**E 7**

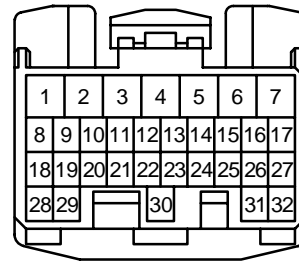

**E 8**

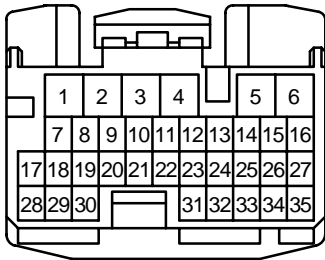

**E 9**

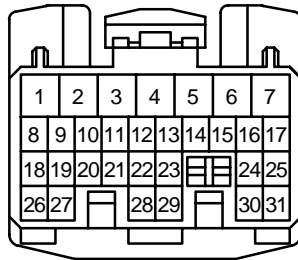

**F 1**  
Brown

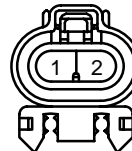

**F 2**  
Brown

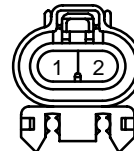

**F 3**  
Gray



**F 4**  
Gray



**F 5**  
Black



**F 8**



**F 9**



**F 10**

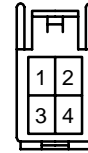

**F 11**

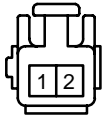

**F 12**  
Dark Gray



**F 14**  
Dark Gray

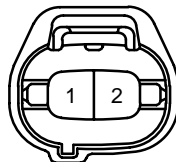

**F 15**  
Black

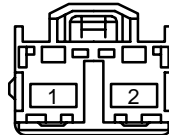

**F 16**  
Black

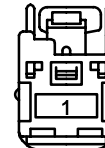

**F 17**  
Black

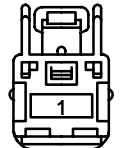

**F 18**  
Black

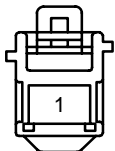

**F 19**

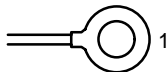

**G 1**  
Black



**G 2**

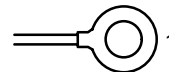

**G 3**



**G 4**  
Gray

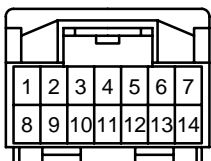

**H 1**  
Black

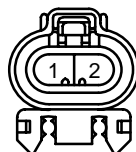

**H 2**  
Brown

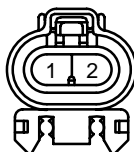

**H 3**  
Black

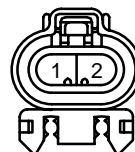

**H 4**  
Brown

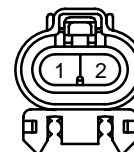

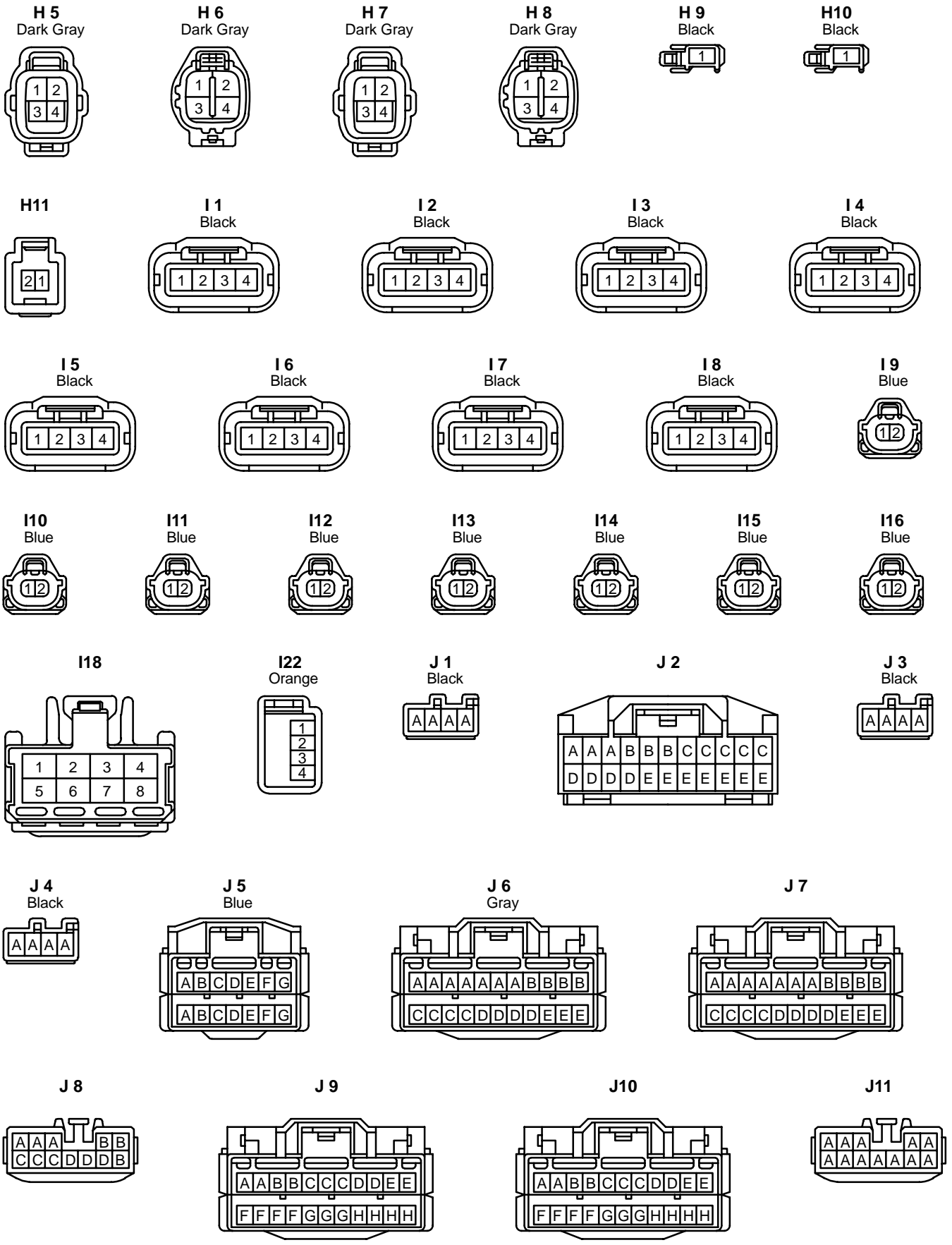

# K CONNECTOR LIST

