

Toyota Corolla 2009 2010 Toyota Electrical Wiring Diagrams

Full download: <http://manualplace.com/download/toyota-corolla-2009-2010-toyota-electrical-wiring-diagrams/>

ABS <w/ VSC , Except TMC Made> , TRAC <Except TMC Made> , VSC <Except TMC Made>

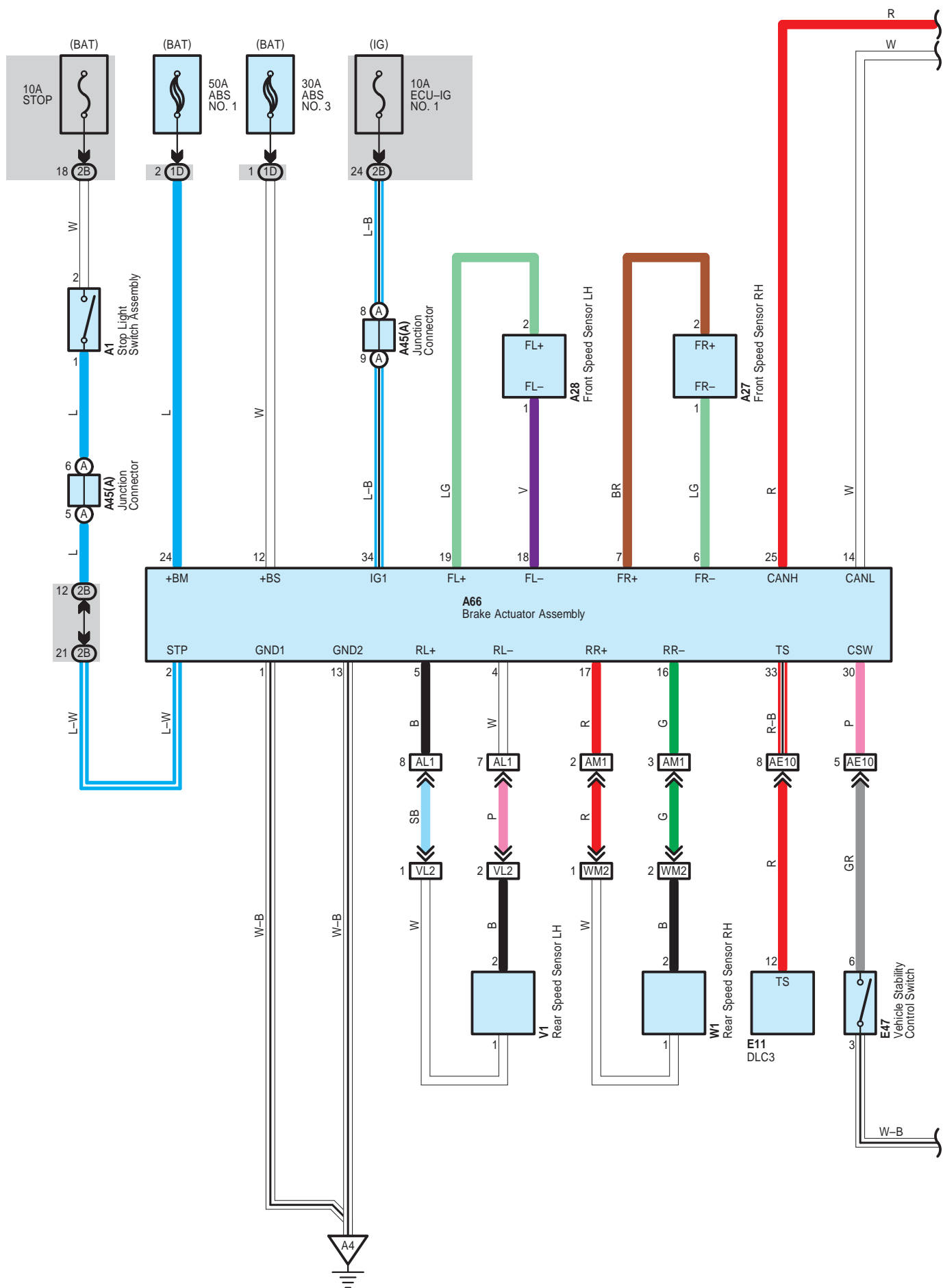

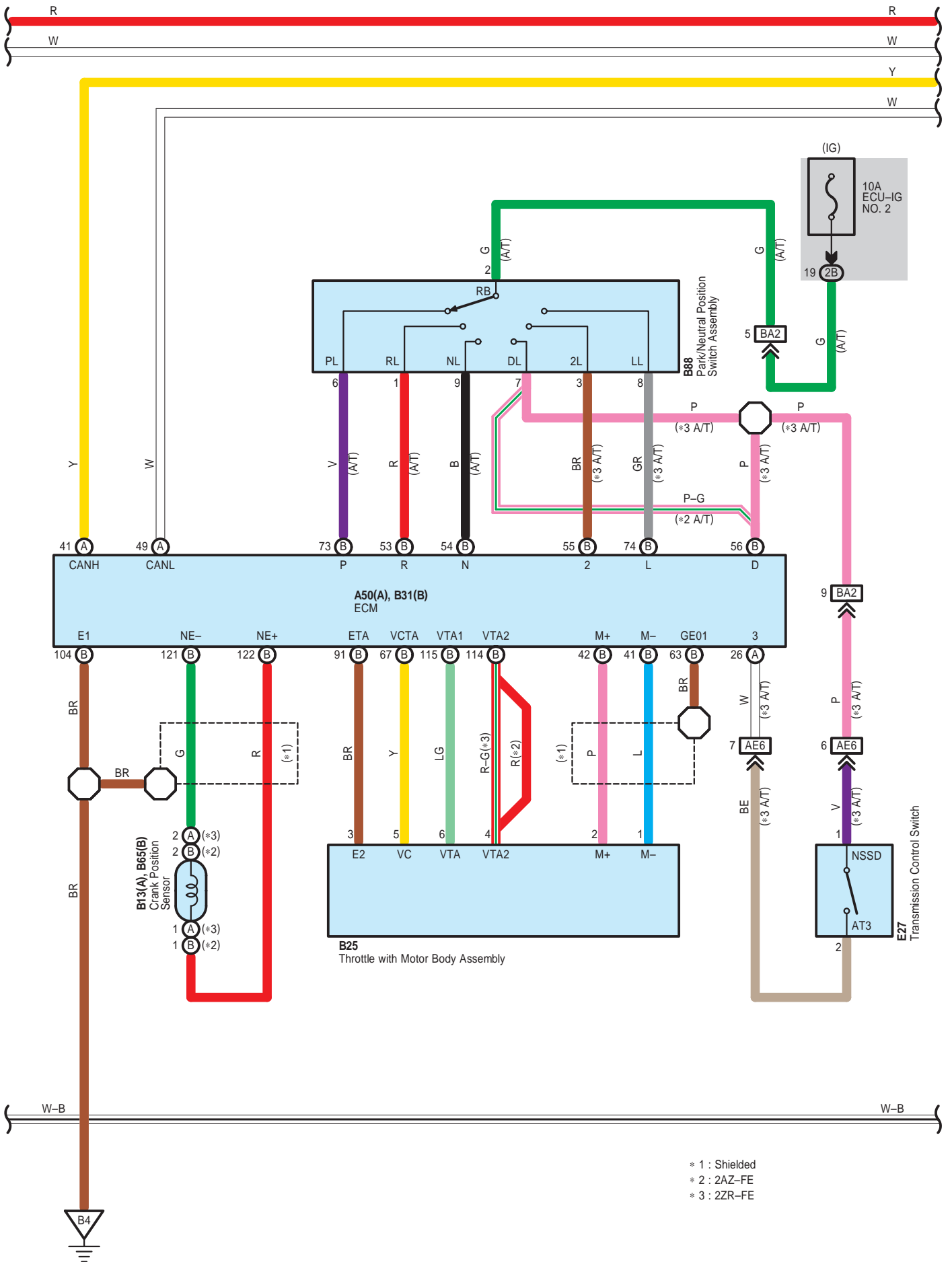

* 1 : Shielded
 * 2 : 2AZ-FE
 * 3 : 2ZR-FE

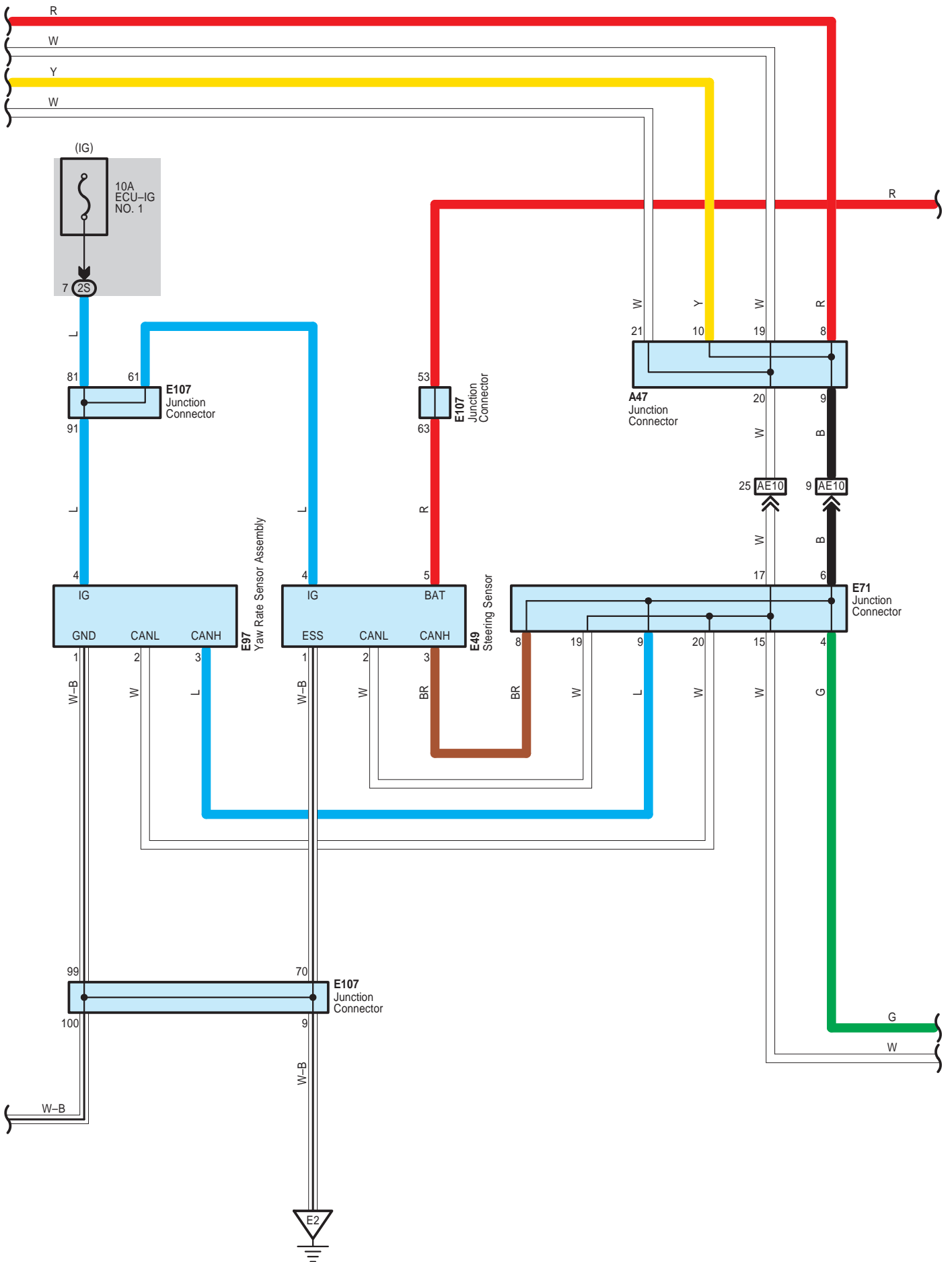

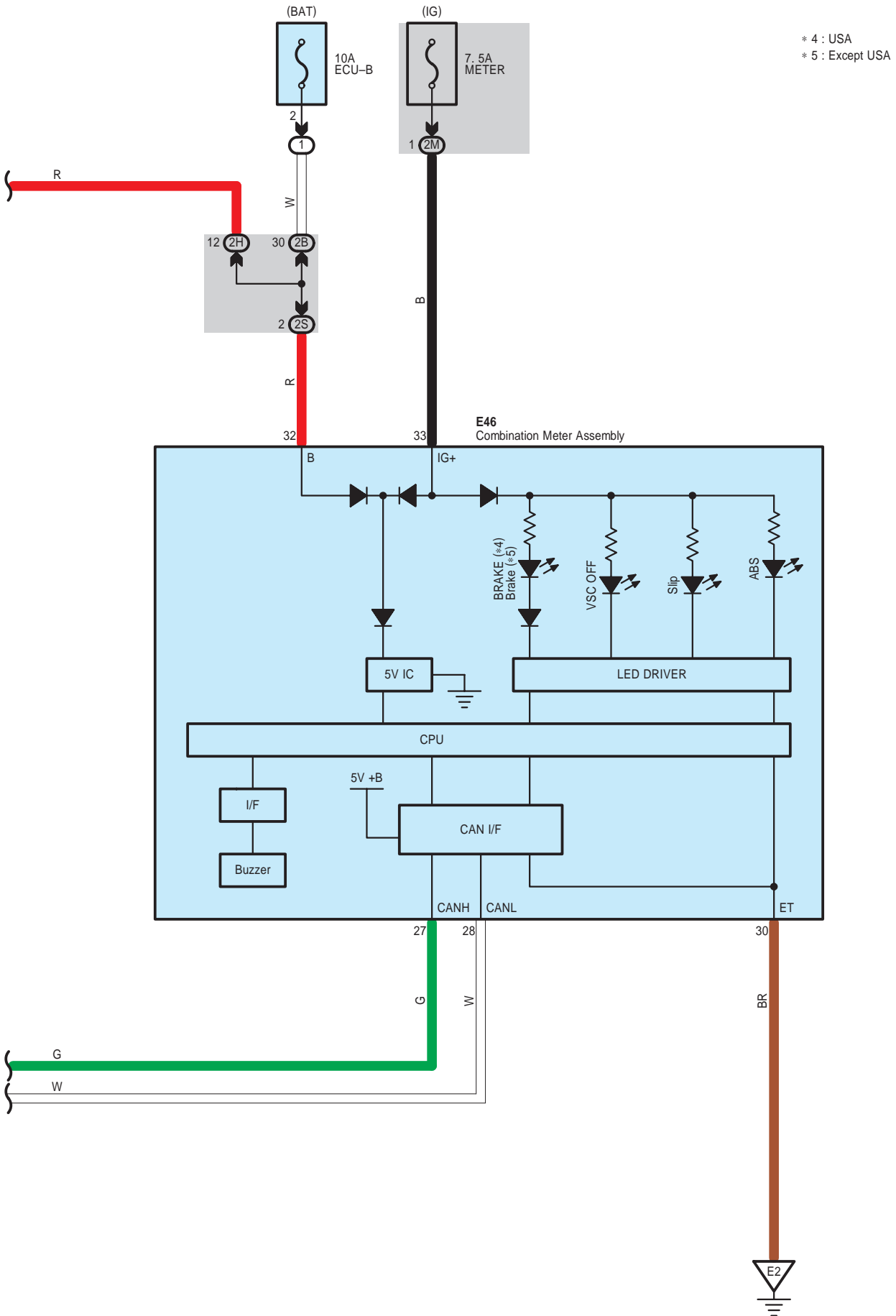

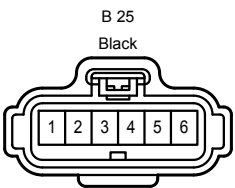
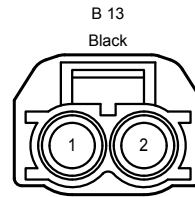
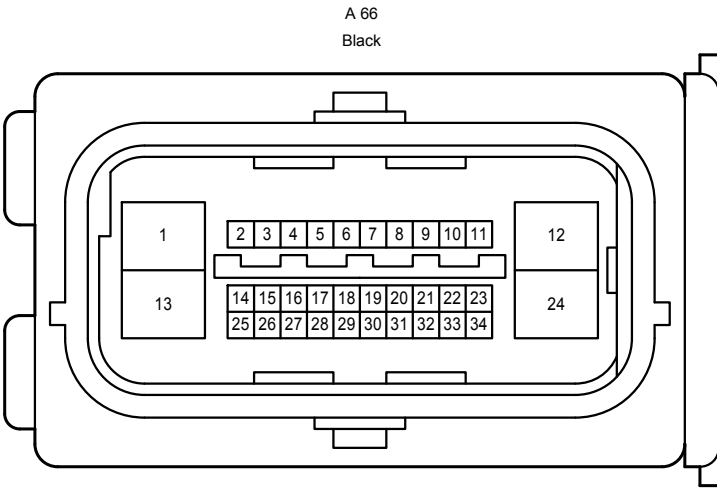
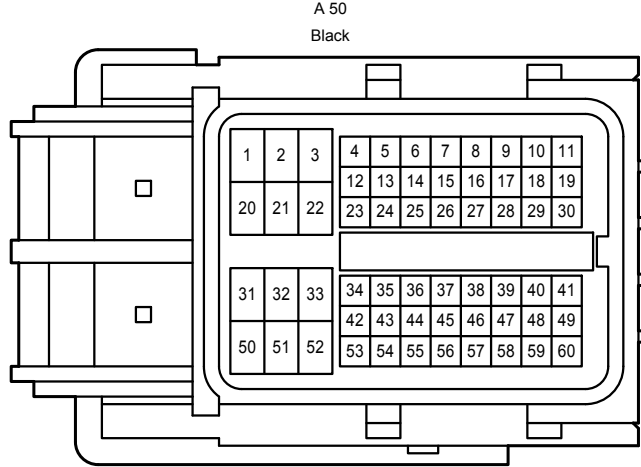
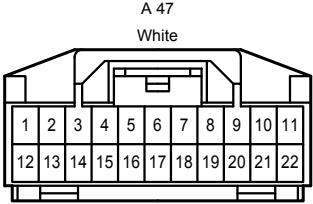
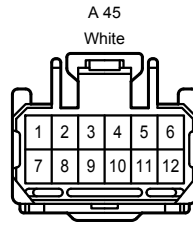
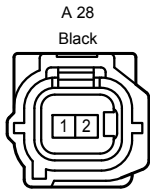
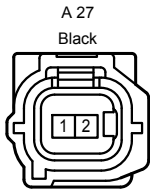
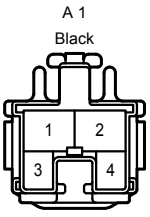

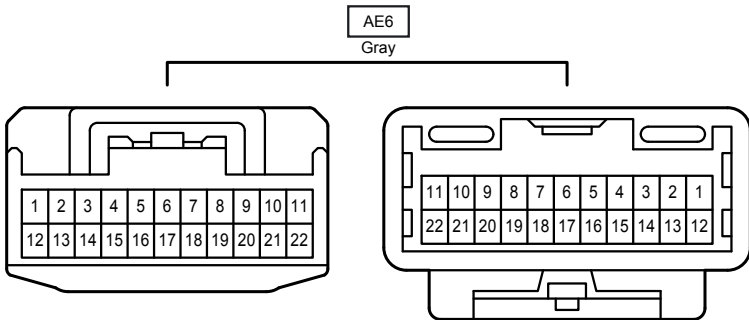
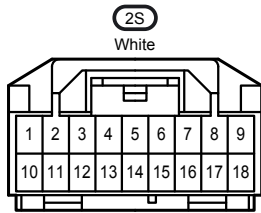
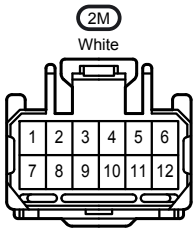
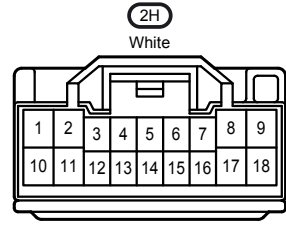
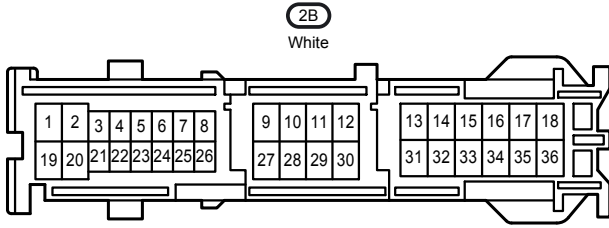
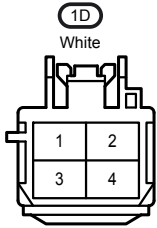
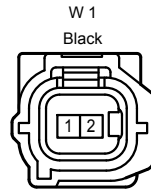
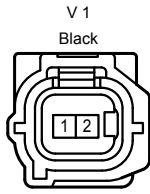
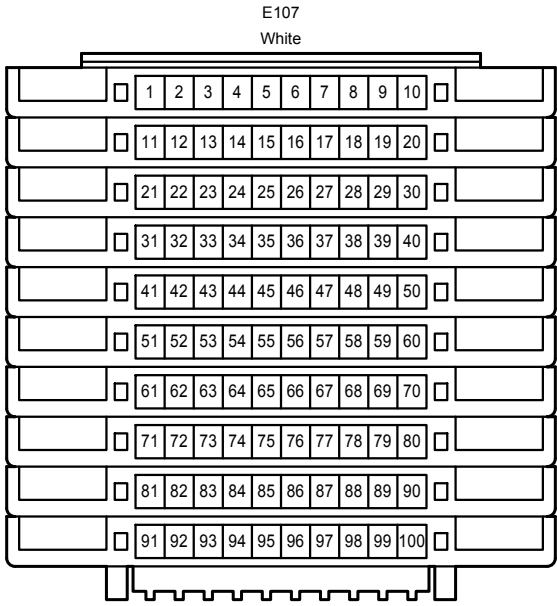

AE10
Gray

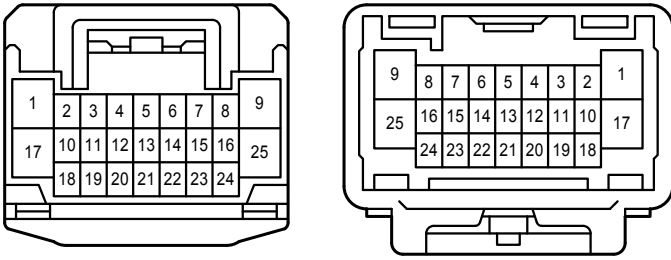

AL1
White

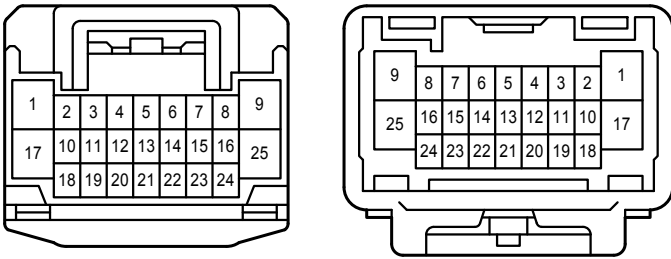

AM1
White

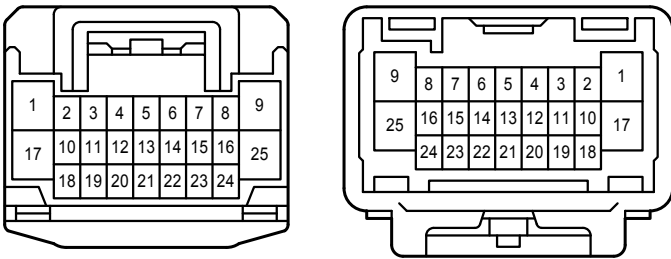

BA2
White

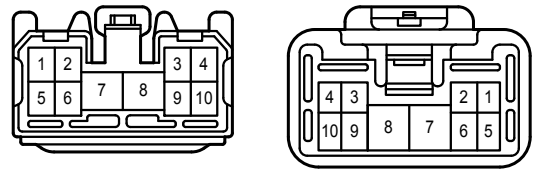

VL2

Black White

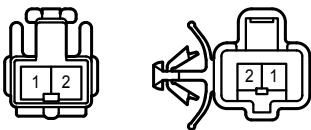

WM2

Black White

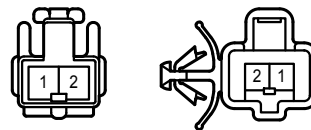

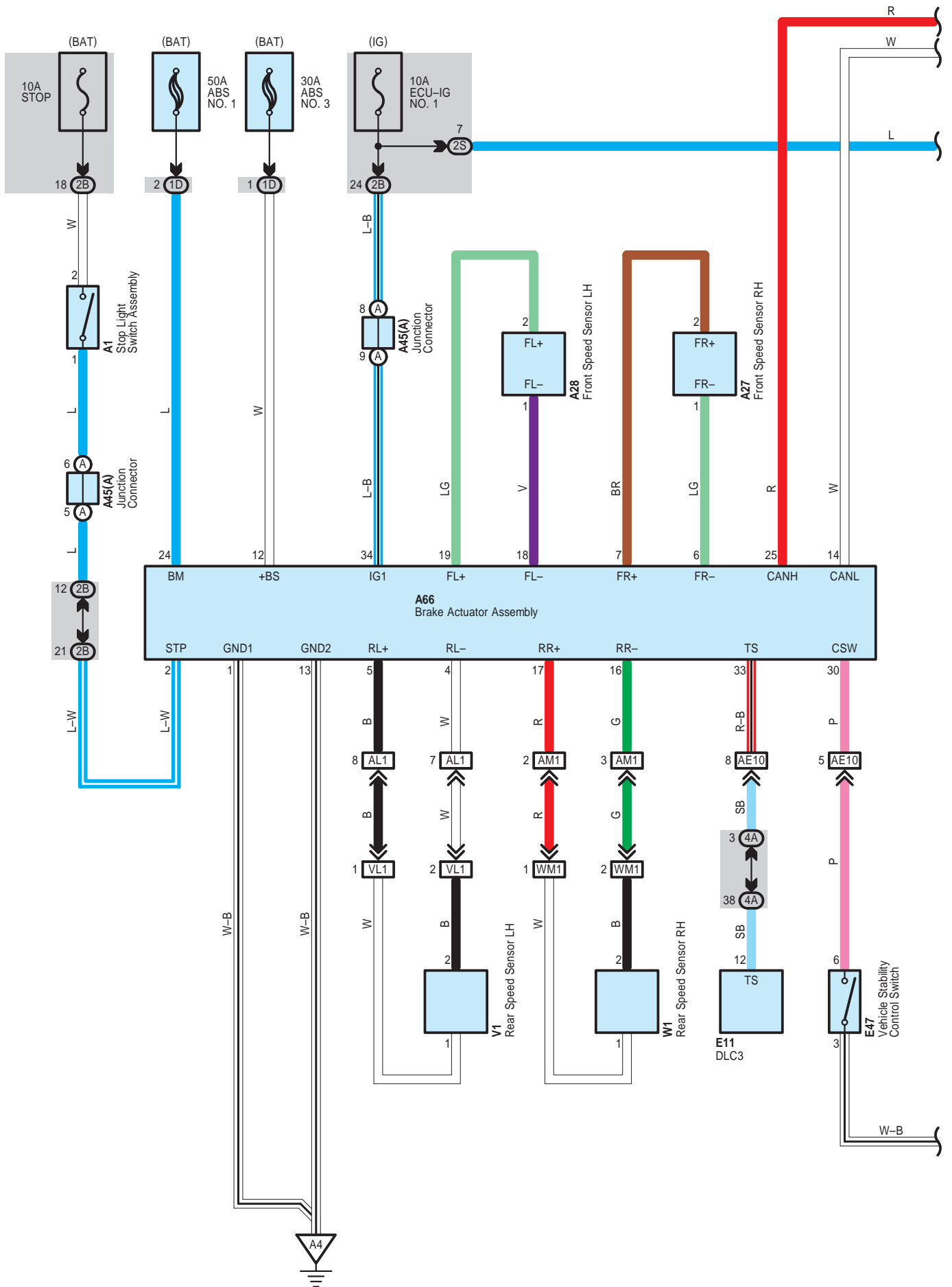

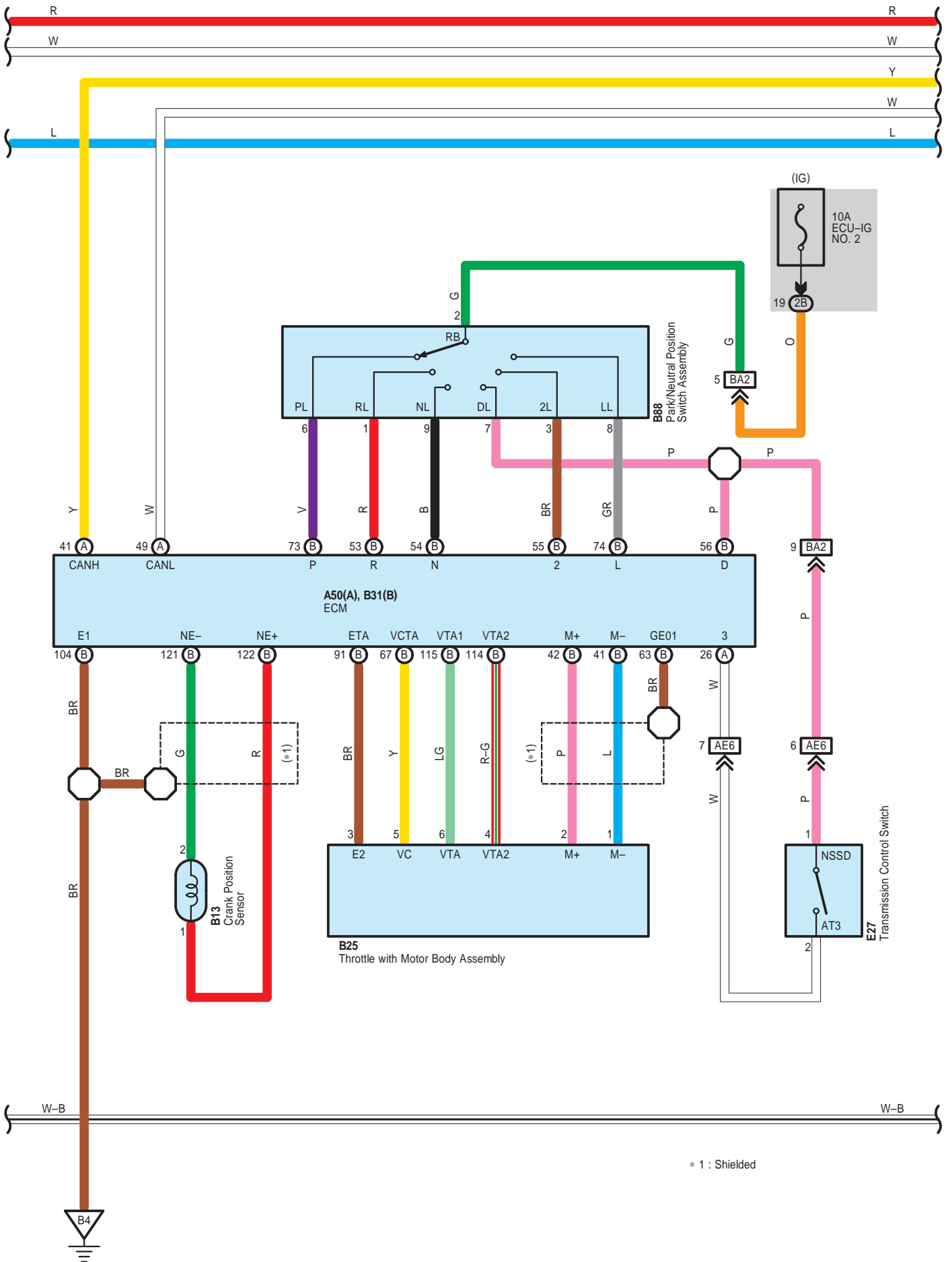

* 1 : Shielded

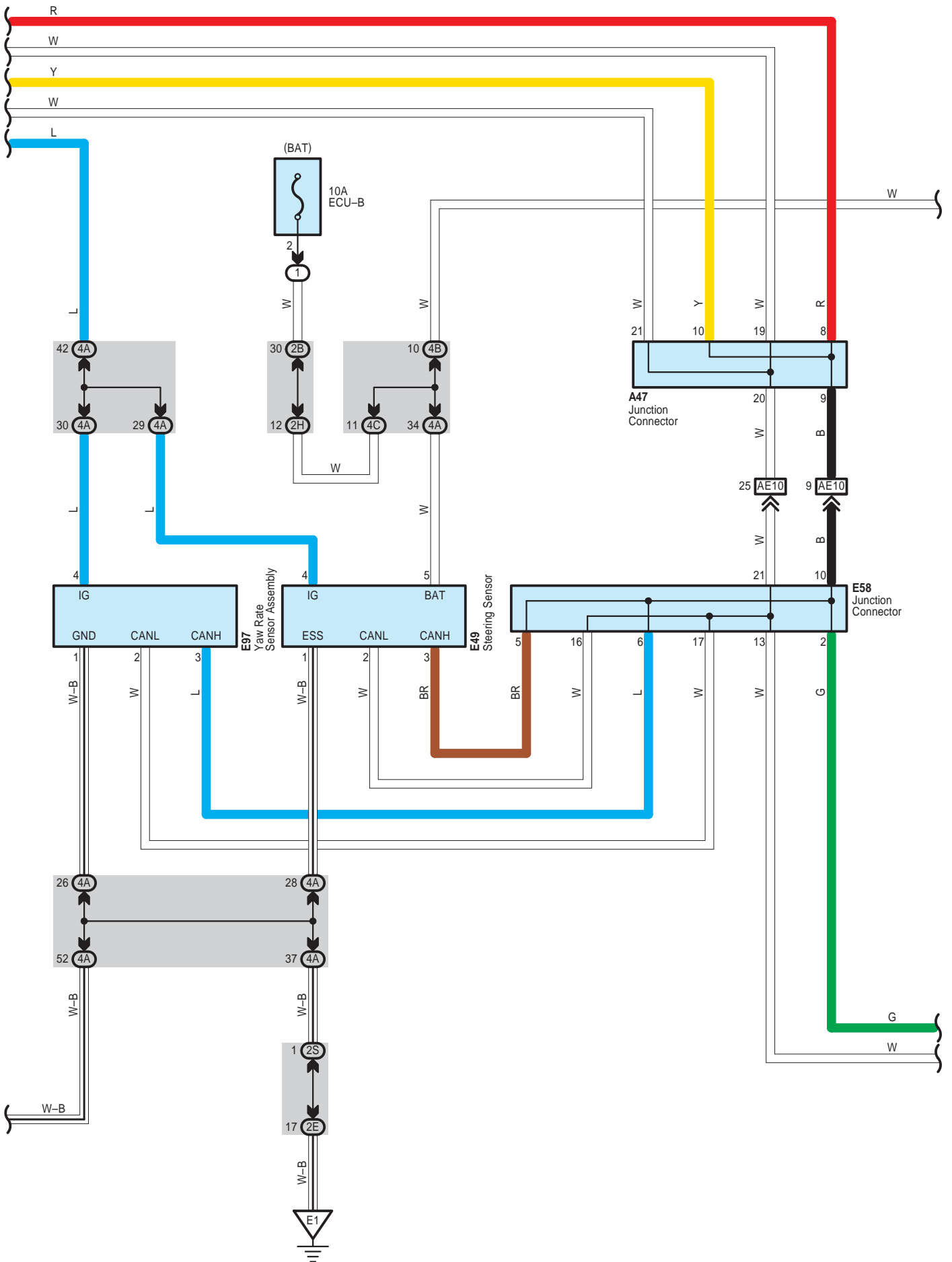

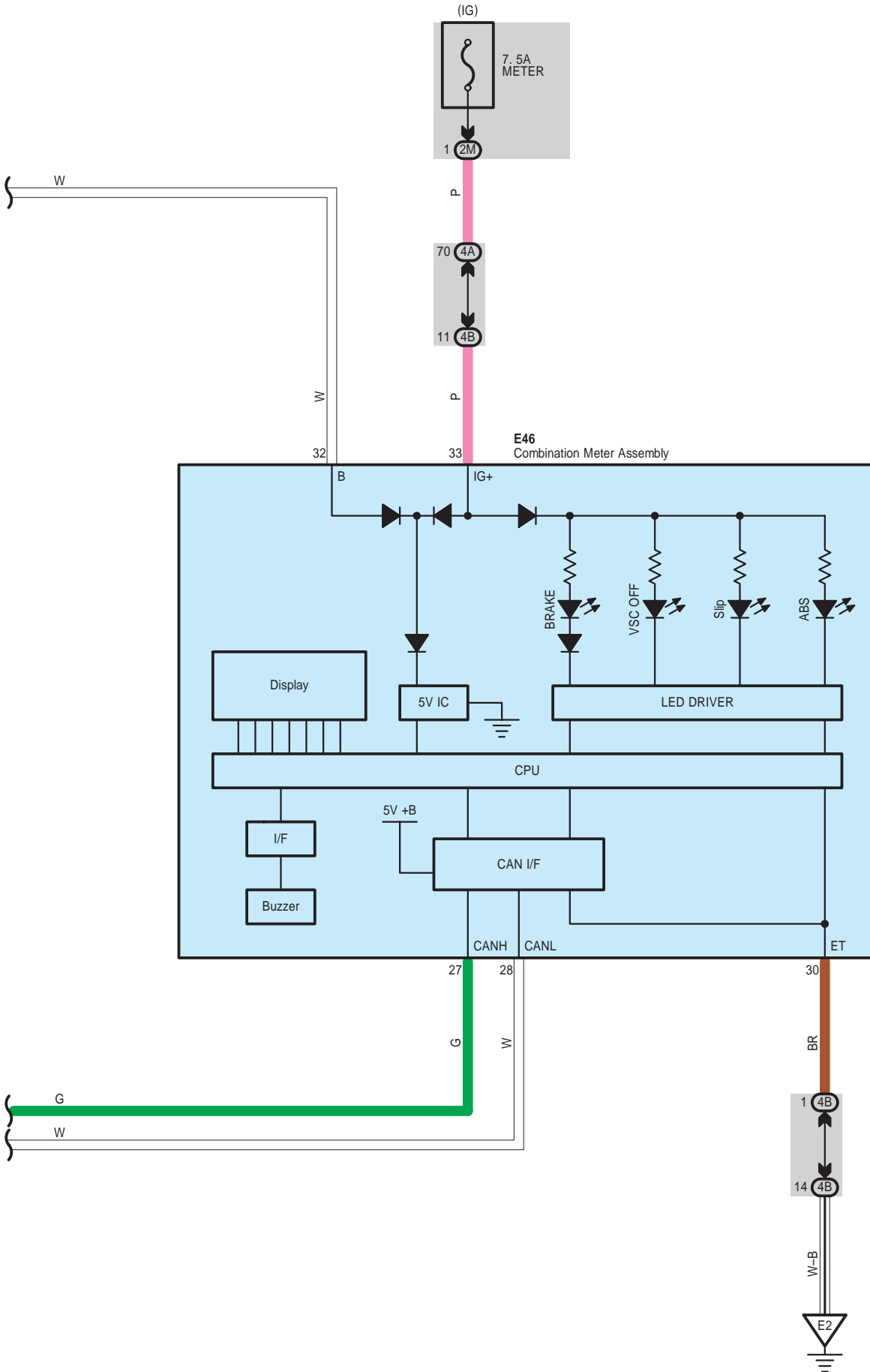

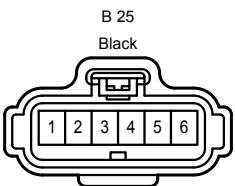
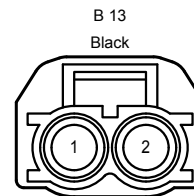
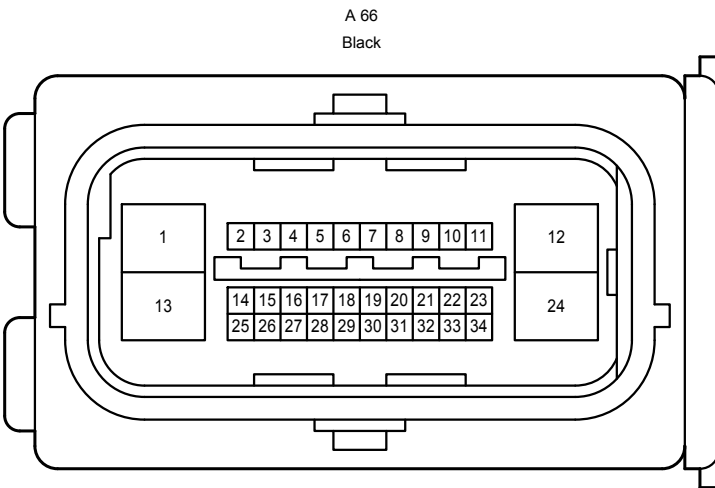
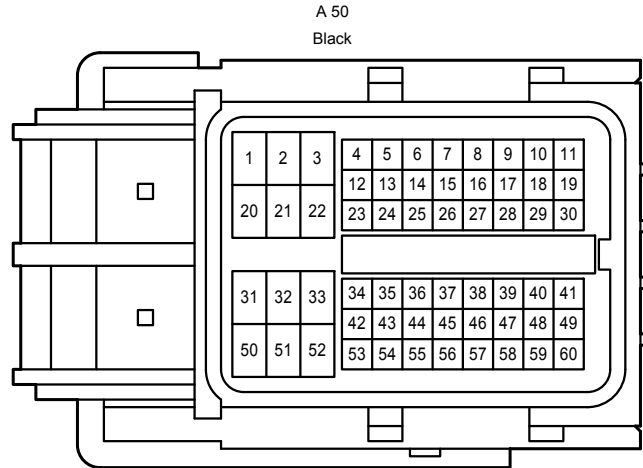
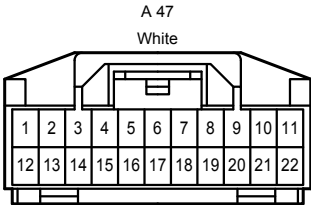
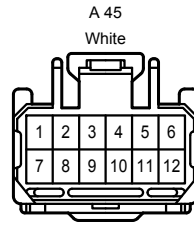
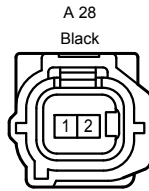
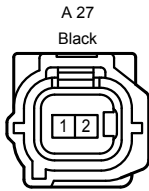
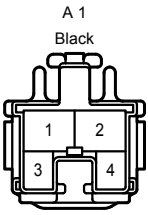

B 31
Black

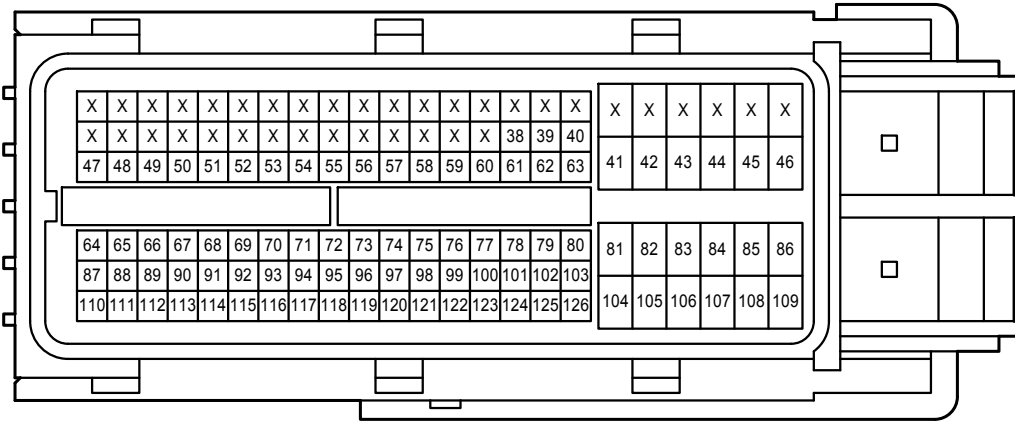

B 88
Gray

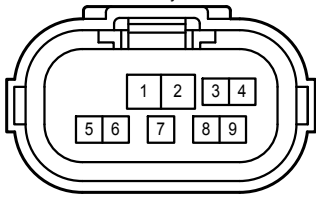

E 11
White

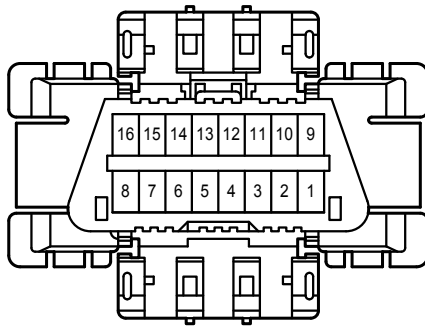

E 27
White

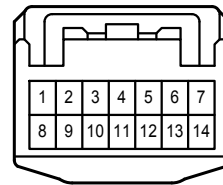

E 46
White

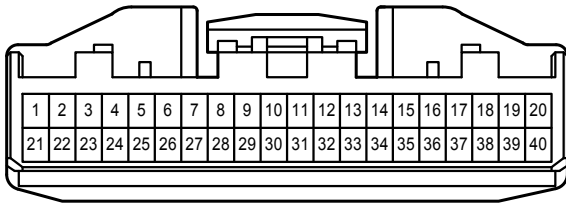

E 47
White

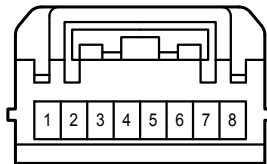

E 49
Black

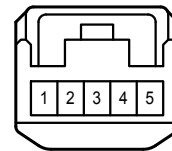

E 58
Gray

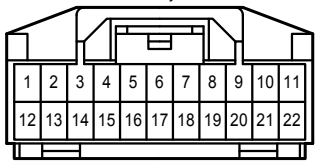

E 97
Black

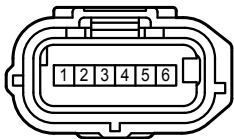

V 1
Black

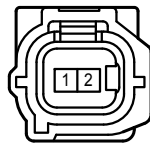

W 1
Black

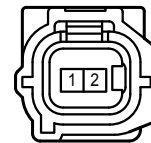

1D
White

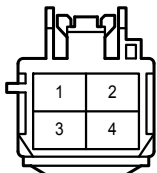

2B
White

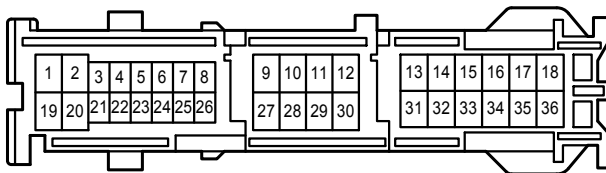

2E
White

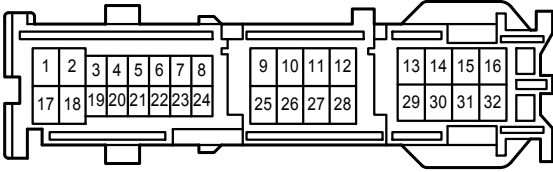

2H
White

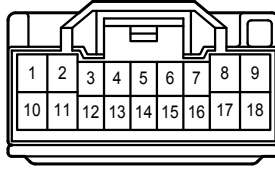

2M
White

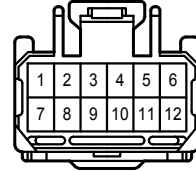

2S
White

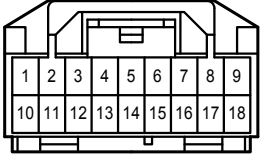

4A
White

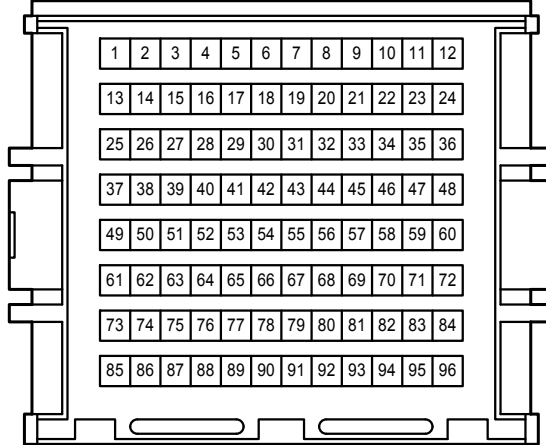

4B
White

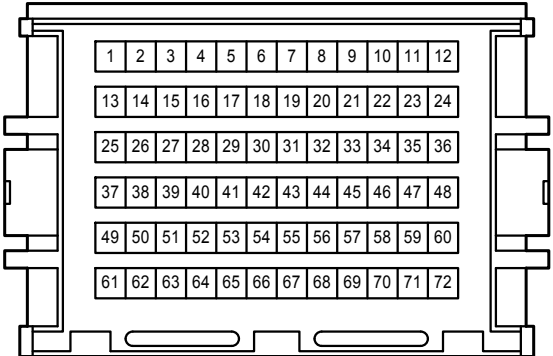

4C
White

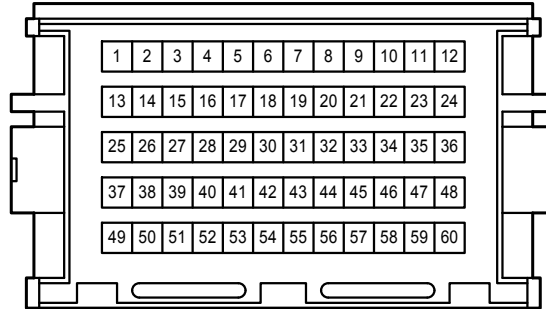

AE6
Gray

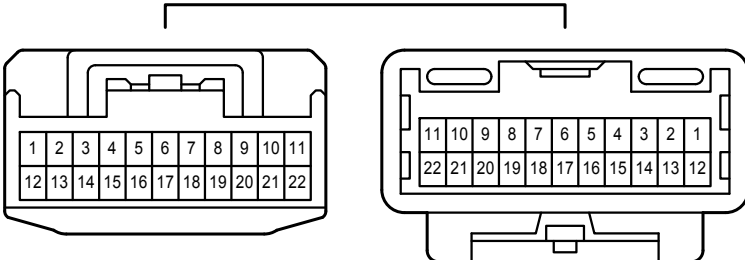

AE10
Gray

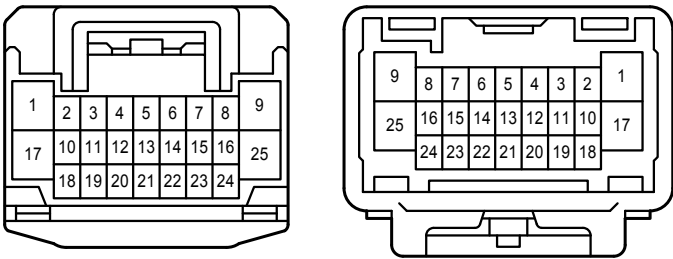

AL1
White

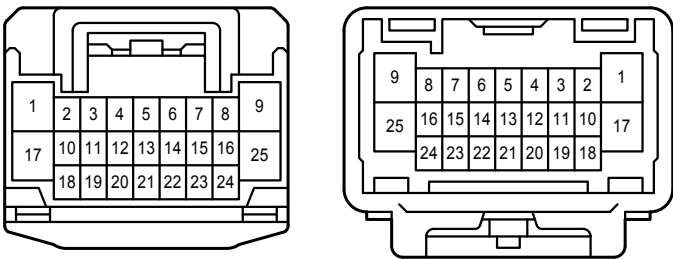

AM1
White

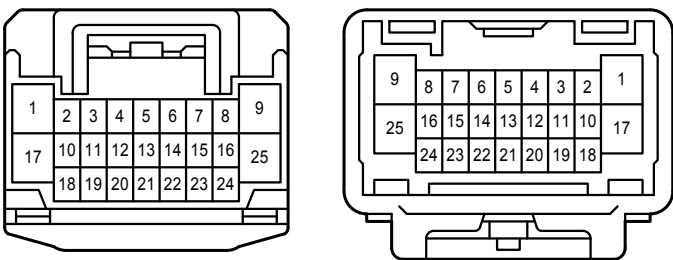

BA2
White

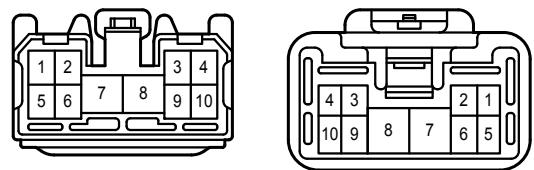

VL1
Black

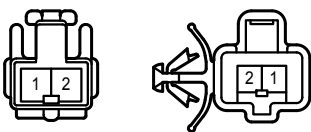

WM1
Black

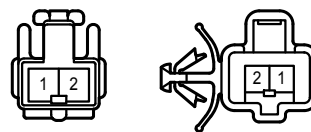

ABS <w/o VSC , Except TMC Made>

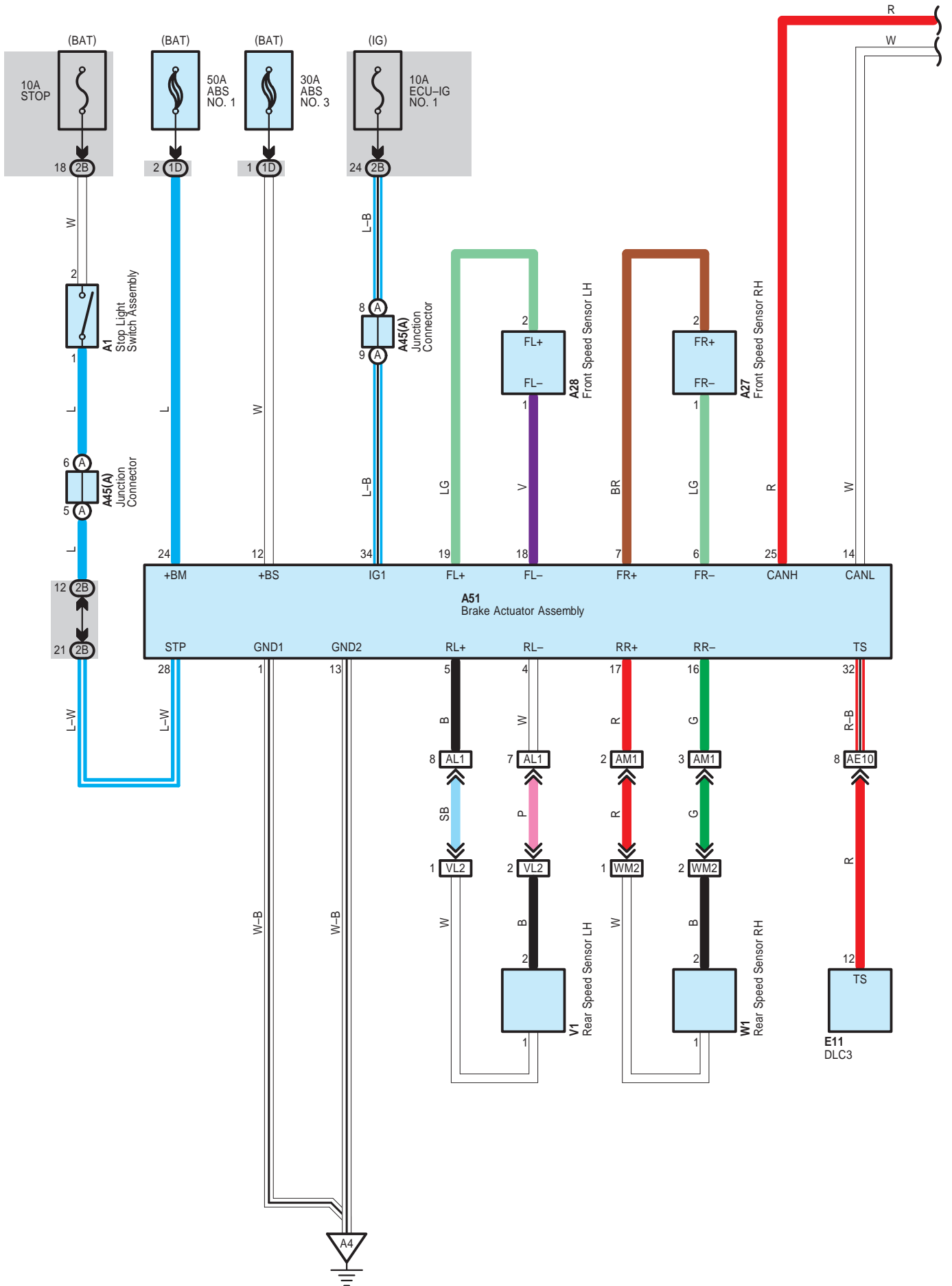

ABS <w/o VSC , Except TMC Made>

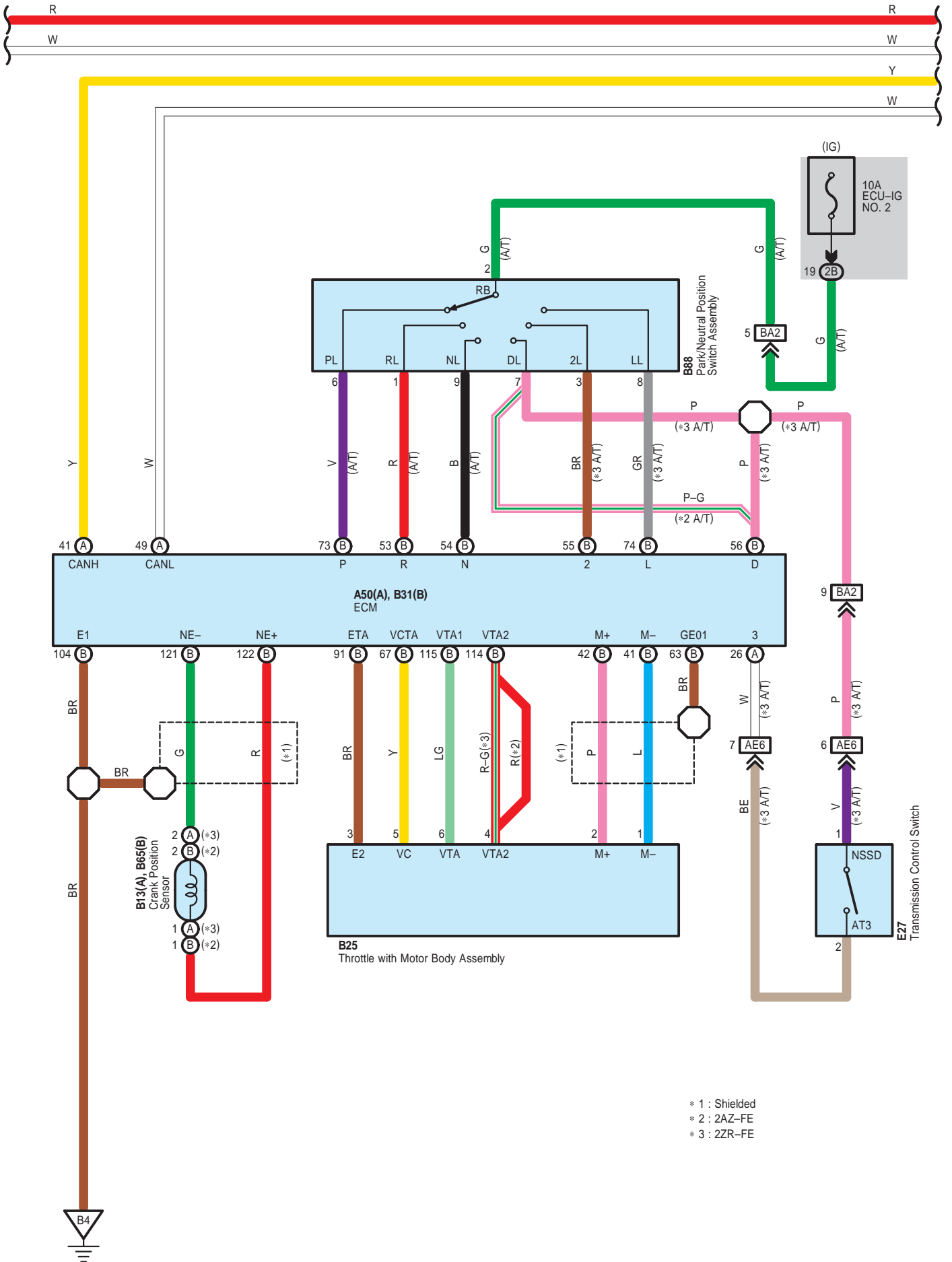

- * 1 : Shielded
- * 2 : 2AZ-FE
- * 3 : 2ZR-FE

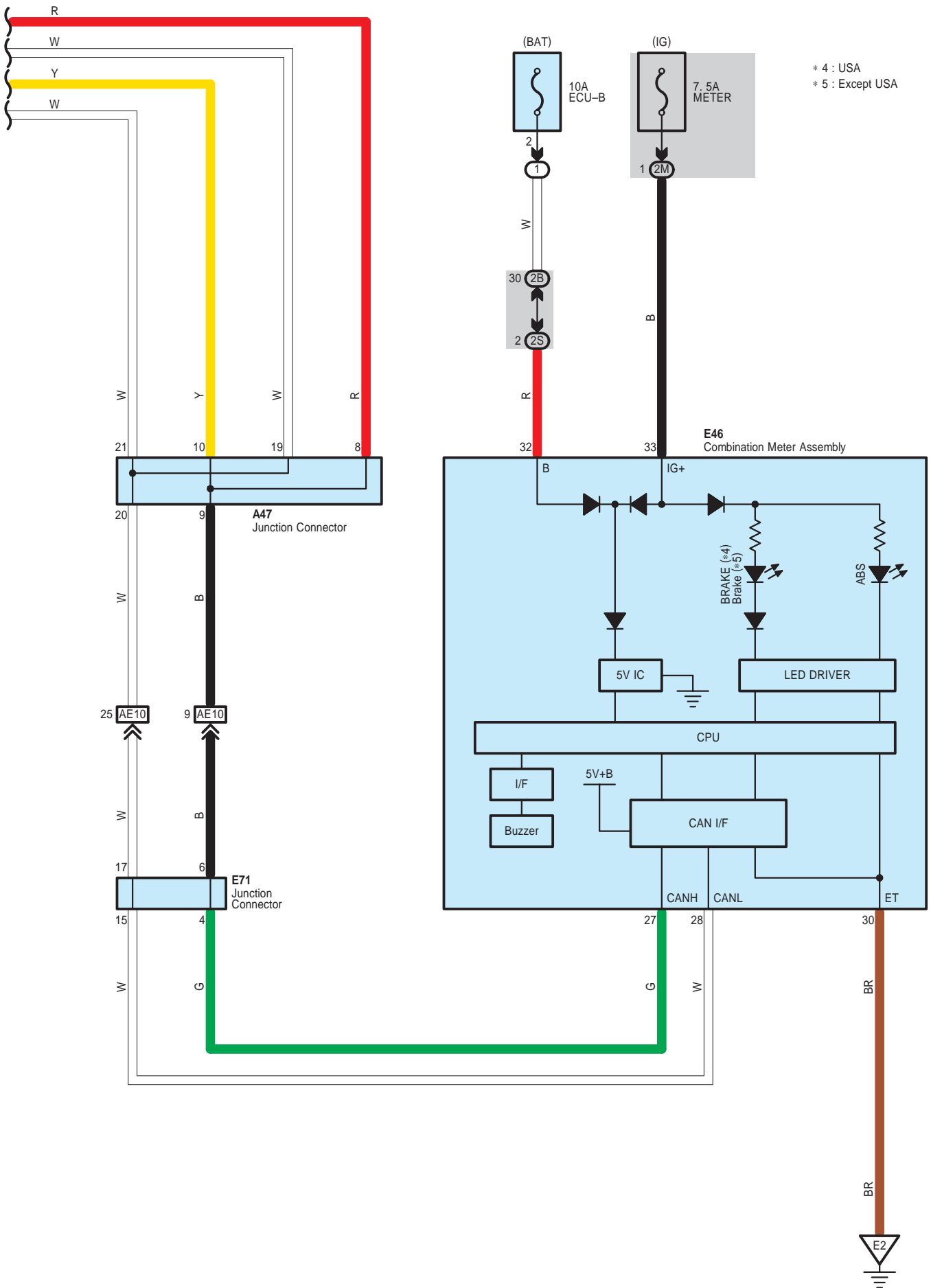

Toyota Corolla 2009 2010 Toyota Electrical Wiring Diagrams

Full download: <http://manualplace.com/download/toyota-corolla-2009-2010-toyota-electrical-wiring-diagrams/>

ABS <w/o VSC , Except TMC Made>

