



ERSATZTEILLISTE

Spare Parts List
Catalogue de pièces détachées
Catalogo parti di ricambio
Catálogo de recambio

ELEKTRO GABELSTAPLER

Electric Fork Truck
Chariot élévateur électrique
Carrello elevatore elettrico
Carretilla elevadora eléctrica

STILL ELECTRONIC DOCUMENTATION SYSTEM

RX20-14
RX20-15
RX20-16
RX20-18
RX20-20



6209 6210 6211 6212 6213 6214 6215 6216 6217

first in intralogistics

0 170 022 - 08/2005

Fig	Part-No.	Qty.	Description	Remark	validity	trucks
▶			PRODUCT INFORMATION			
▶			ELECTRIC MOTOR			
▶			MECHANICAL DRIVE AXLE			
▶			CHASSIS			
▶			OPERATOR'S COMPARTMENT			
▶			STEERING SYSTEM			
▶			WHEELS AND TYRES			
▶			BRAKING SYSTEM			
▶			CONTROLS			
▶			DISPLAY ELEMENT			
▶			ELECTRICS; ELECTRONICS			
▶			ELECTRONIC CONTROLS			
▶			HYDRAULIC			
▶			WORKING HYDRAULICS			
▶			LOAD LIFTING SYSTEM			
▶			MAST			
▶			LOAD CARRIER			
▶			ATTACHMENTS			
▶			SPECIAL EQUIPMENT NARROW AISLE TRUCKS			
▶			OTHER ACCESSORIES			

STILL Service



DEUTSCHLAND

IDENT-NR: 905146 ORDER-NO:



STILL-
Service
 international.



INTERNATIONAL

IDENT-NR: 157528 ORDER-NO:

Fig	Part-No.	Qty.	Description	Remark	validity	trucks
			DOCUMENTATION			

Fig	Part-No.	Qty.	Description	Remark	validity	trucks
▶			DOCUMENTATION	Battery		
▶			DOCUMENTATION	RX20-16; Komatsu		
▶			DOCUMENTATION	option		

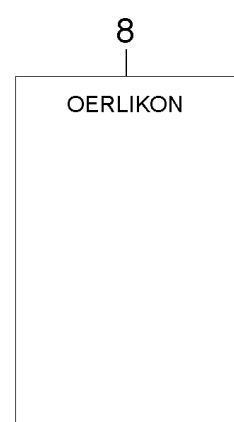
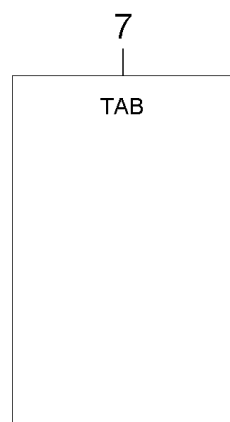
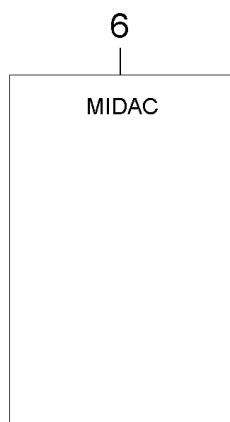
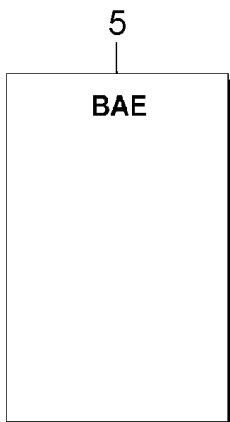
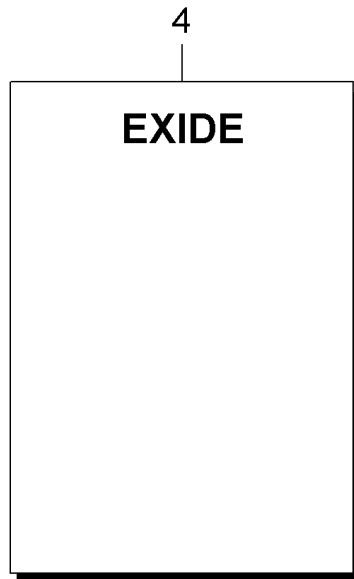
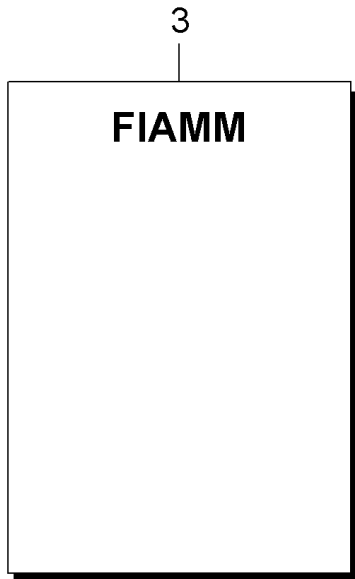
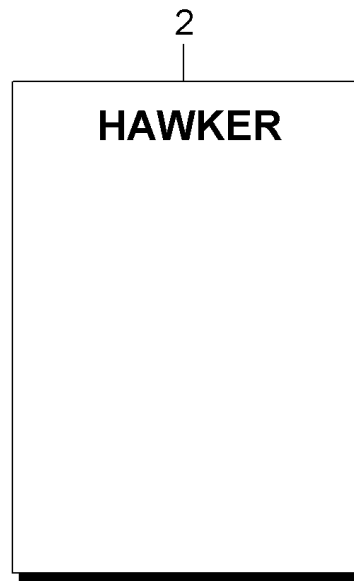
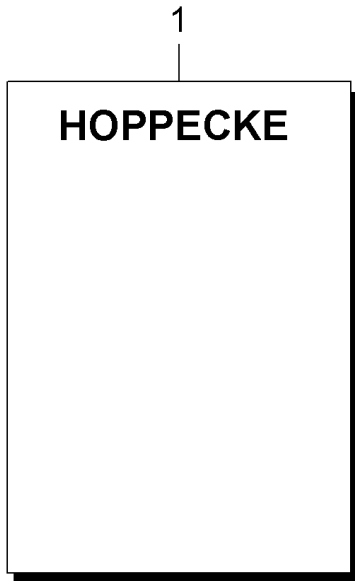
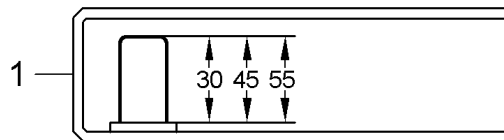

Fig	Part-No.	Qty.	Description	Remark	validity	trucks
1	0170186		OPERAT. INSTRUCTIONS	Hoppecke		
2	0170187		OPERAT. INSTRUCTIONS	HAWKER		
3	0170188		OPERAT. INSTRUCTIONS	FIAMM		
4	0170189		OPERAT. INSTRUCTIONS	EXIDE		
5	0170190		OPERAT. INSTRUCTIONS	BAE		
6	50988011640		UM	INSTRUCTION MANUAL STILL / MIDAC		
7	50988011641		UM	INSTRUCTION MANUAL TAB		
8	50988011642		UM	INSTRUCTION MANUAL OERLIKON		



2



1

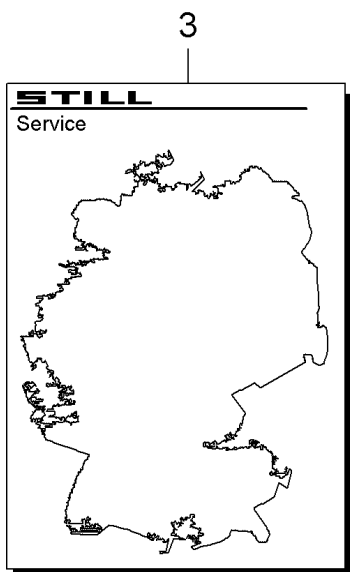

3

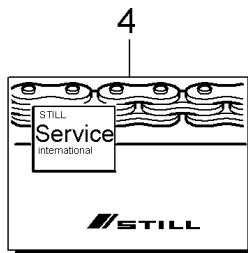

4



5



6

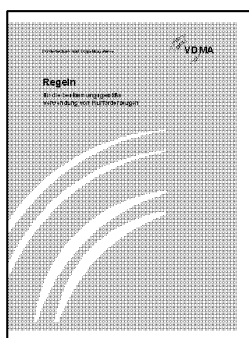

7

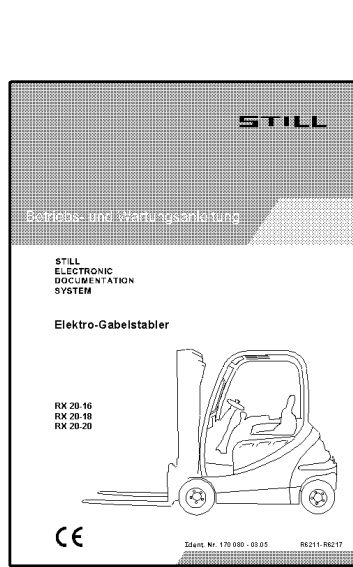

8

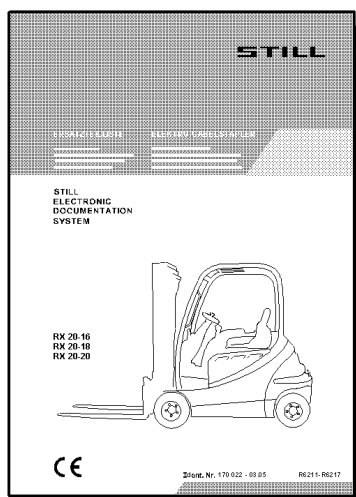

9



ABB: D

<http://www.still.de>

14300

Fig	Part-No.	Qty.	Description	Remark	validity	trucks
1	0146792	1	FILE	fill level = 30 mm 30 mm		
1	0146793		FILE	fill level = 45 mm 45 mm		
1	0146794		FILE	fill level = 55 mm 55 mm		
2	0148920	1	STICKER			
3	0905146	1	OVERVIEW OF FROMS STILL SERVICE A4	Germany only		
4	0157528		SERVICE BOOKLET			
5	0148837	1	SERVICE INFORMATION	Germany only		
6	0135745	1	CHECK BOOK	Germany only		
7	0170208	1	GUIDELINE	DE Verband Deutscher Maschinen- und Anlagenbau e.V.; German		
7	0170209		GUIDELINE	EN Verband Deutscher Maschinen- und Anlagenbau e.V.; English		
7	0170210		GUIDELINE	FR Verband Deutscher Maschinen- und Anlagenbau e.V.; French		
7	0170211		GUIDELINE	ES Verband Deutscher Maschinen- und Anlagenbau e.V.; Spanish		
7	0170212		GUIDELINE	IT Verband Deutscher Maschinen- und Anlagenbau e.V.; Italian		
7	0170215		GUIDELINE	DA Verband Deutscher Maschinen- und Anlagenbau e.V.; Danish		
7	0170213		GUIDELINE	NL Verband Deutscher Maschinen- und Anlagenbau e.V.; Dutch		
7	0170217		GUIDELINE	PT Verband Deutscher Maschinen- und Anlagenbau e.V.; Portugese		
7	0170219		GUIDELINE	EL Verband Deutscher Maschinen- und Anlagenbau e.V.; Greek		
7	0170214		GUIDELINE	SV Verband Deutscher Maschinen- und Anlagenbau e.V.; Swedish		
7	0170216		GUIDELINE	NO Verband Deutscher Maschinen- und Anlagenbau e.V.; Norwegian		
7	0170218		GUIDELINE	FI Verband Deutscher Maschinen- und Anlagenbau e.V.; Finnish		
7	0170225		GUIDELINE	PL Verband Deutscher Maschinen- und Anlagenbau e.V.; Polish		

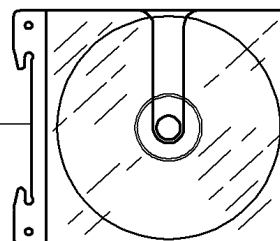
Fig	Part-No.	Qty.	Description	Remark	validity	trucks
7	0170224		GUIDELINE	HU Verband Deutscher Maschinen- und Anlagenbau e.V.; Hungarian		
7	0170220		GUIDELINE	CZ Verband Deutscher Maschinen- und Anlagenbau e.V.; Czech		
7	0170226		GUIDELINE	SK Verband Deutscher Maschinen- und Anlagenbau e.V.; Slovakian		
7	0170227		GUIDELINE	SL Verband Deutscher Maschinen- und Anlagenbau e.V.; Slovenian		
7	0170221		GUIDELINE	ET Verband Deutscher Maschinen- und Anlagenbau e.V.; Estonian		
7	0170223		GUIDELINE	LV Verband Deutscher Maschinen- und Anlagenbau e.V.; Latvian		
7	0170222		GUIDELINE	LT Verband Deutscher Maschinen- und Anlagenbau e.V.; Lithuanian		
7	0170228		GUIDELINE	TR Verband Deutscher Maschinen- und Anlagenbau e.V.; Turkish		
7	0170229		GUIDELINE	RU Verband Deutscher Maschinen- und Anlagenbau e.V.; Russian		
8	0170080	1	OPERAT. INSTRUCTIONS	D		
8	0170081		OPERAT. INSTRUCTIONS	GB		
8	0170082		OPERAT. INSTRUCTIONS	F		
8	0170083		OPERAT. INSTRUCTIONS	I		
8	0170084		OPERAT. INSTRUCTIONS	E		
8	0170085		OPERAT. INSTRUCTIONS	DK		
8	0170086		OPERAT. INSTRUCTIONS	NL		
8	0170087		OPERAT. INSTRUCTIONS	P		
8	0170088		OPERAT. INSTRUCTIONS	GR		
8	0170089		OPERAT. INSTRUCTIONS	S		
8	0170090		OPERAT. INSTRUCTIONS	N		
8	0170091		OPERAT. INSTRUCTIONS	FIN		
8	0170092		OPERAT. INSTRUCTIONS	RUS		
8	0170093		OPERAT. INSTRUCTIONS	PL		
8	0170094		OPERAT. INSTRUCTIONS	rear		
8	0170095		OPERAT. INSTRUCTIONS	CZ		
8	0170096		OPERAT. INSTRUCTIONS	SK		
8	0170097		OPERAT. INSTRUCTIONS	SLO		
8	0170098		OPERAT. INSTRUCTIONS	EST		
8	0170099		OPERAT. INSTRUCTIONS	LV		
8	0170100		OPERAT. INSTRUCTIONS	LT		
8	0170101		OPERAT. INSTRUCTIONS	IS		

Fig	Part-No.	Qty.	Description	Remark	validity	trucks
8	0170102		OPERAT. INSTRUCTIONS	TR		
9	0170022		SPARE PARTS LIST			

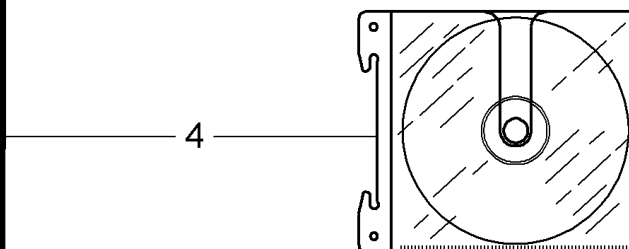
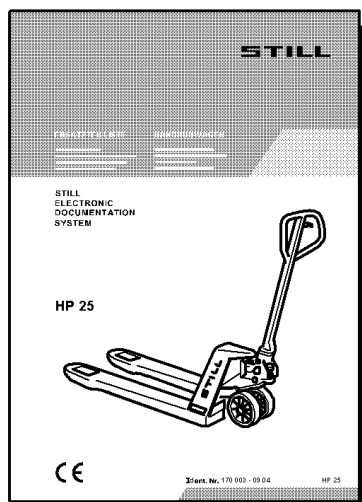
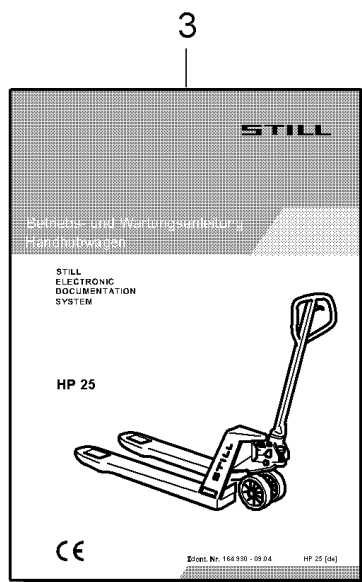

Fig	Part-No.	Qty.	Description	Remark	validity	trucks
1	0163964		OPERAT. INSTRUCTIONS	restraint system		
2	0170335		OPERAT. INSTRUCTIONS	D		
2	0170336		OPERAT. INSTRUCTIONS	GB		
2	0170337		OPERAT. INSTRUCTIONS	F		
2	0170338		OPERAT. INSTRUCTIONS	I		
2	0170339		OPERAT. INSTRUCTIONS			
2	0170340		OPERAT. INSTRUCTIONS	DK		
2	0170341		OPERAT. INSTRUCTIONS	NL		
2	0170342		OPERAT. INSTRUCTIONS	P		
2	0170343		OPERAT. INSTRUCTIONS	GR		
2	0170344		OPERAT. INSTRUCTIONS	S		
2	0170345		OPERAT. INSTRUCTIONS	N		
2	0170346		OPERAT. INSTRUCTIONS	FIN		
2	0170347		OPERAT. INSTRUCTIONS	RUS		
2	0170348		OPERAT. INSTRUCTIONS	PL		
2	0170349		OPERAT. INSTRUCTIONS	rear		
2	0170350		OPERAT. INSTRUCTIONS	CZ		
2	0170351		OPERAT. INSTRUCTIONS	SK		
2	0170352		OPERAT. INSTRUCTIONS	SLO		
2	0170353		OPERAT. INSTRUCTIONS	EST		
2	0170354		OPERAT. INSTRUCTIONS	LV		
2	0170355		OPERAT. INSTRUCTIONS	LT		
2	0170356		OPERAT. INSTRUCTIONS	IS		
2	0170357		OPERAT. INSTRUCTIONS	TR		
3	0164930		OPERAT. INSTRUCTIONS	D		
3	0164980		OPERAT. INSTRUCTIONS	GB		
3	0164981		OPERAT. INSTRUCTIONS	F		
3	0164982		OPERAT. INSTRUCTIONS	I		
3	0164983		OPERAT. INSTRUCTIONS	E		
3	0164984		OPERAT. INSTRUCTIONS	DK		
3	0164985		OPERAT. INSTRUCTIONS	NL		
3	0164986		OPERAT. INSTRUCTIONS	P		
3	0164987		OPERAT. INSTRUCTIONS	GR		
3	0164988		OPERAT. INSTRUCTIONS	S		
3	0164989		OPERAT. INSTRUCTIONS	N		
3	0164990		OPERAT. INSTRUCTIONS	FIN		
3	0164991		OPERAT. INSTRUCTIONS	RUS		
3	0164992		OPERAT. INSTRUCTIONS	PL		
3	0164993		OPERAT. INSTRUCTIONS	rear		
3	0164994		OPERAT. INSTRUCTIONS	CZ		
3	0164995		OPERAT. INSTRUCTIONS	SK		
3	0164996		OPERAT. INSTRUCTIONS	SLO		
4	0170003		SPARE PARTS LIST	CD-ROM		

Fig	Part-No.	Qty.	Description	Remark	validity	trucks
▶			MOTOR			
▶			PUMP MOTOR		->30.09.2008	
▶			PUMP MOTOR		01.10.2008- >04.09.2014	
▶			PUMP MOTOR		05.09.2014- >05.02.2015	
▶			PUMP MOTOR		06.02.2015->	

MOTOR

RX20 6210-6217

Fig	Part-No.	Qty.	Description	Remark	validity	trucks
▶			MOTOR	left	->03.05.2012	
▶			MOTOR	left	04.05.2012- >31.05.2013	
▶			DRIVE MOTOR	left	01.06.2013- >04.09.2014	
▶			MOTOR	left	05.09.2014->	
▶			MOTOR	right	->03.05.2012	
▶			MOTOR	right	04.05.2012- >04.09.2014	
▶			MOTOR	right	05.09.2014->	