



**ERSATZTEILLISTE**

Spare Parts List  
Catalogue de pièces détachées  
Catalogo parti di ricambio  
Catálogo de recambio

**ELEKTRO GABELSTAPLER**

Electric Fork Truck  
Chariot élévateur électrique  
Carrello elevatore elettrico  
Carretilla elevadora eléctrica

**STILL**  
**ELECTRONIC**  
**DOCUMENTATION**  
**SYSTEM**

**RX60-40**  
**RX60-45**  
**RX60-50**



6327 6328 6329

0 171 324 - 06/2006

first in intralogistics

Fig	Part-No.	Qty.	Description	Remark	Norm	Type
▶			PRODUCT INFORMATION			
▶			ELECTRIC MOTOR			
▶			MECHANICAL DRIVE AXLE			
▶			CHASSIS			
▶			OPERATOR'S COMPARTMENT			
▶			STEERING SYSTEM			
▶			WHEELS AND TYRES			
▶			BRAKING SYSTEM			
▶			CONTROLS			
▶			DISPLAY ELEMENT			
▶			ELECTRICS; ELECTRONICS			
▶			ELECTRONIC CONTROLS			
▶			HYDRAULICS			
▶			WORKING HYDRAULICS			
▶			VALVE			
▶			LOAD LIFTING SYSTEM			
▶			MAST			
▶			LOAD CARRIER			
▶			ATTACHMENTS			
▶			SPECIAL EQUIPMENT NARROW AISLE TRUCKS			
▶			OTHER ACCESSORIES			

**STILL**  
Service

■ Werk  
 ■ Werkniederlassung  
 ■ Service-Stützpunkt  
 ▲ Vertretungsstellen  
 (Adressen s. Rückseite)

DEUTSCHLAND  
 IDENT-NR: 905146  
 ORDER-NO:

STILL-Service international.

  
 Wir wollen was bewegen.

INTERNATIONAL  
 IDENT-NR: 157528  
 ORDER-NO:

---

Fig	Part-No.	Qty.	Description	Remark	Norm	Type
			DOCUMENTATION			



---

Fig	Part-No.	Qty.	Description	Remark	Norm	Type
▶			DOCUMENTATION	Battery		
▶			DOCUMENTATION	option		

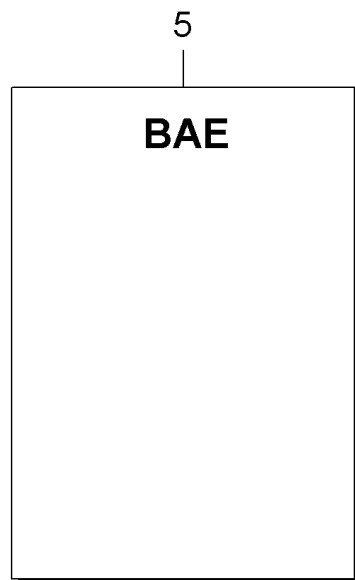
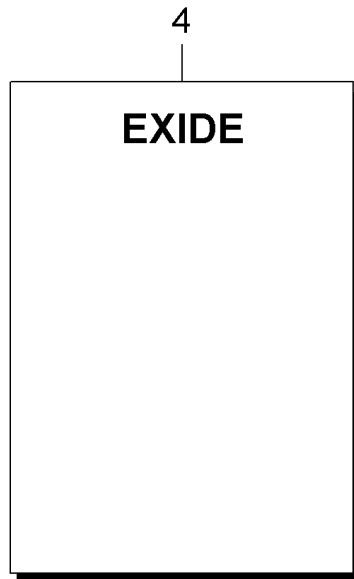
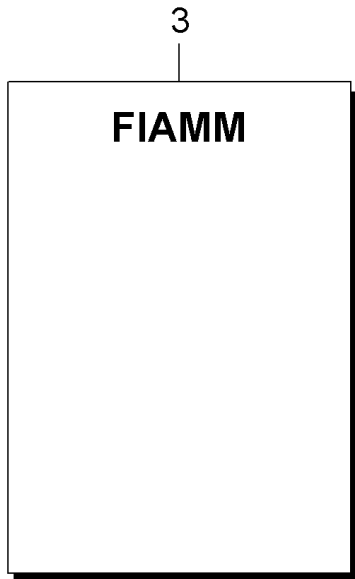
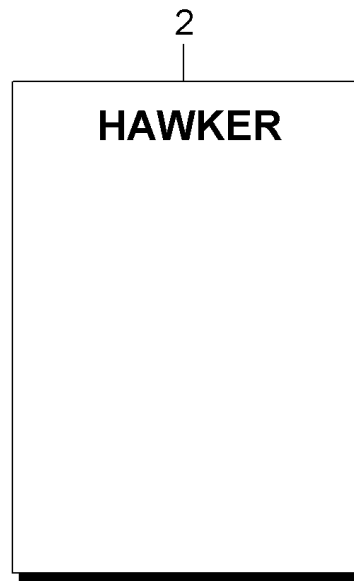
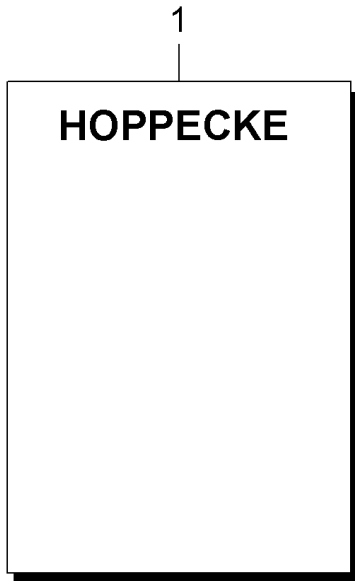

Fig	Part-No.	Qty.	Description	Remark	Norm	Type
2	0170187		OPERAT. INSTRUCTIONS	HAWKER		
1	0170186		OPERAT. INSTRUCTIONS	Hoppecke		
3	0170188		OPERAT. INSTRUCTIONS	FIAMM		
4	0170189		OPERAT. INSTRUCTIONS	EXIDE		
5	0170190		OPERAT. INSTRUCTIONS	BAE		



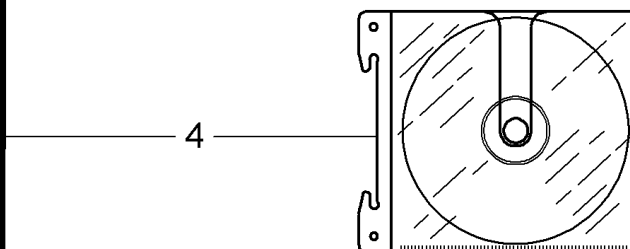
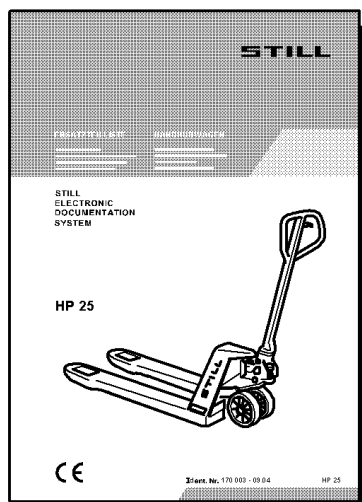

Fig	Part-No.	Qty.	Description	Remark	Norm	Type
1	0163964		OPERAT. INSTRUCTIONS	restraint system		
2	0170335		OPERAT. INSTRUCTIONS	D		
2	0170336		OPERAT. INSTRUCTIONS	GB		
2	0170337		OPERAT. INSTRUCTIONS	F		
2	0170338		OPERAT. INSTRUCTIONS	I		
2	0170339		OPERAT. INSTRUCTIONS			
2	0170340		OPERAT. INSTRUCTIONS	DK		
2	0170341		OPERAT. INSTRUCTIONS	NL		
2	0170342		OPERAT. INSTRUCTIONS	P		
2	0170343		OPERAT. INSTRUCTIONS	GR		
2	0170344		OPERAT. INSTRUCTIONS	S		
2	0170345		OPERAT. INSTRUCTIONS	N		
2	0170346		OPERAT. INSTRUCTIONS	FIN		
2	0170347		OPERAT. INSTRUCTIONS	RUS		
2	0170348		OPERAT. INSTRUCTIONS	PL		
2	0170349		OPERAT. INSTRUCTIONS	rear		
2	0170350		OPERAT. INSTRUCTIONS	CZ		
2	0170351		OPERAT. INSTRUCTIONS	SK		
2	0170352		OPERAT. INSTRUCTIONS	SLO		
2	0170353		OPERAT. INSTRUCTIONS	EST		
2	0170354		OPERAT. INSTRUCTIONS	LV		
2	0170355		OPERAT. INSTRUCTIONS	LT		
2	0170356		OPERAT. INSTRUCTIONS	IS		
2	0170357		OPERAT. INSTRUCTIONS	TR		
3	0164930		OPERAT. INSTRUCTIONS	D		
3	0164980		OPERAT. INSTRUCTIONS	GB		
3	0164981		OPERAT. INSTRUCTIONS	F		
3	0164982		OPERAT. INSTRUCTIONS	I		
3	0164983		OPERAT. INSTRUCTIONS	E		
3	0164984		OPERAT. INSTRUCTIONS	DK		
3	0164985		OPERAT. INSTRUCTIONS	NL		
3	0164986		OPERAT. INSTRUCTIONS	P		



Fig	Part-No.	Qty.	Description	Remark	Norm	Type
3	0164987		OPERAT. INSTRUCTIONS	GR		
3	0164988		OPERAT. INSTRUCTIONS	S		
3	0164989		OPERAT. INSTRUCTIONS	N		
3	0164990		OPERAT. INSTRUCTIONS	FIN		
3	0164991		OPERAT. INSTRUCTIONS	RUS		
3	0164992		OPERAT. INSTRUCTIONS	PL		
3	0164993		OPERAT. INSTRUCTIONS	rear		
3	0164994		OPERAT. INSTRUCTIONS	CZ		
3	0164995		OPERAT. INSTRUCTIONS	SK		
3	0164996		OPERAT. INSTRUCTIONS	SLO		
4	0170003		SPARE PARTS LIST	CD-ROM		



---

Fig	Part-No.	Qty.	Description	Remark	Norm	Type
▶			MOTOR			









---

Fig	Part-No.	Qty.	Description	Remark	Norm	Type
▶			GEARING			
▶			GEAR DRIVE			



**GEARING**