

## QUICK REFERENCE INDEX

# NISSAN

MODEL S14 SERIES

GENERAL INFORMATION _____	GI
MAINTENANCE _____	MA
ENGINE MECHANICAL _____	EM
ENGINE LUBRICATION & _____ COOLING SYSTEMS	LC
ENGINE CONTROL SYSTEM _____	EC
ACCELERATOR CONTROL, FUEL & _____ EXHAUST SYSTEMS	FE
CLUTCH _____	CL
MANUAL TRANSMISSION _____	MT
AUTOMATIC TRANSMISSION _____	AT
PROPELLER SHAFT & _____ DIFFERENTIAL CARRIER	PD
FRONT AXLE & FRONT SUSPENSION _____	FA
REAR AXLE & REAR SUSPENSION _____	RA
BRAKE SYSTEM _____	BR
STEERING SYSTEM _____	ST
RESTRAINT SYSTEM _____	RS
BODY & TRIM _____	BT
HEATER & AIR CONDITIONER _____	HA
ELECTRICAL SYSTEM _____	EL
ALPHABETICAL INDEX _____	IDX

## PRECAUTIONS

Observe the following precautions to ensure safe and proper servicing.

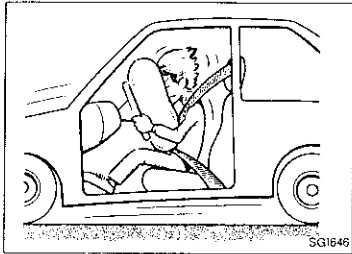

### Precautions for Supplemental Restraint System "AIR BAG" and "SEAT BELT PRE-TENSIONER"

The Supplemental Restraint System "Air Bag" and "Seat belt pre-tensioner", used along with a seat belt, help to reduce the risk or severity of injury to the driver and front passenger in a frontal collision. The Supplemental Restraint System consists of air bag modules (located in the center of the steering wheel and on the instrument panel on the passenger side), a seat belt pre-tensioner, a diagnosis sensor unit, warning lamp, wiring harness and spiral cable. Information necessary to service the system safely is included in the RS section of this Service Manual.

#### WARNING:

- To avoid rendering the SRS inoperative, which could increase the risk of personal injury or death in the event of a collision which would result in air bag inflation, all maintenance must be performed by an authorized NISSAN dealer.
- Improper maintenance, including incorrect removal and installation of the SRS, can lead to personal injury caused by unintentional activation of the system.
- All SRS electrical wiring harnesses and connectors are covered with yellow outer insulation. Do not use electrical test equipment on any circuit related to the SRS.

### General Precautions

- Do not operate the engine for an extended period of time without proper exhaust ventilation. Keep the work area well ventilated and free of any flammable materials. Special care should be taken when handling any flammable or poisonous materials, such as gasoline, refrigerant gas, etc. When working in a pit or other enclosed area, be sure to properly ventilate the area before working with hazardous materials. Do not smoke while working on the vehicle.

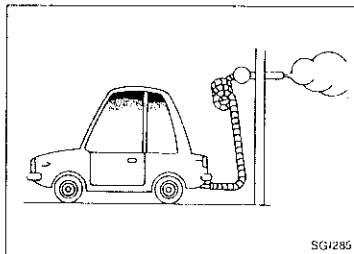

## PRECAUTIONS

### General Precautions (Cont'd)

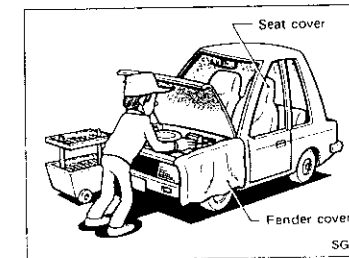
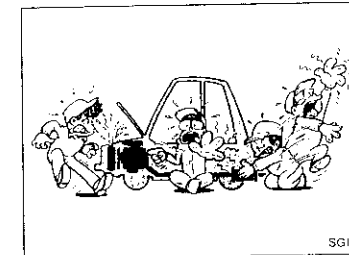
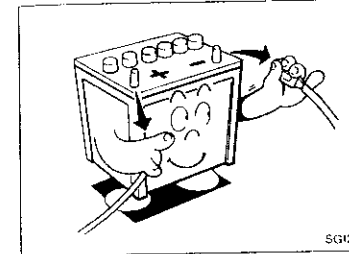
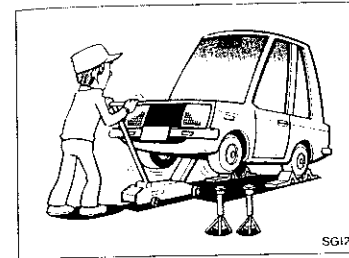

- Before jacking up the vehicle, apply wheel chocks or other tire blocks to the wheels to prevent the vehicle from moving. After jacking up the vehicle, support the vehicle weight with safety stands at the points designated for proper lifting before working on the vehicle. These operations should be done on a level surface.
- When removing a heavy component such as the engine or transaxle/transmission, be careful not to lose your balance and drop them. Also, do not allow them to strike adjacent parts, especially the brake tubes and master cylinder.

- Before starting repairs which do not require battery power, always turn off the ignition switch, then disconnect the ground cable from the battery to prevent accidental short circuit.

- To prevent serious burns, avoid contact with hot metal parts such as the radiator, exhaust manifold, tail pipe and muffler. Do not remove the radiator cap when the engine is hot.

- Before servicing the vehicle, protect fenders, upholstery and carpeting with appropriate covers. Take caution that keys, buckles or buttons on your person do not scratch the paint.

- Clean all disassembled parts in the designated liquid or solvent prior to inspection or assembly.
- Replace oil seals, gaskets, packings, O-rings, locking washers, cotter pins, self-locking nuts, etc. with new ones.
- Replace inner and outer races of tapered roller bearings and needle bearings as a set.
- Arrange the disassembled parts in accordance with their assembled locations and sequence.
- Do not touch the terminals of electrical components which use microcomputers (such as ECMs). Static electricity may damage internal electronic components.

## PRECAUTIONS

### General Precautions (Cont'd)

- After disconnecting vacuum or air hoses, attach a tag to indicate the proper connection.
- Use only the fluids and the lubricants specified in MA section and HA section or their equivalents.
- Use approved bonding agent, sealants or their equivalents when required.
- Use tools and recommended special tools where specified for safe and efficient service repairs.
- When repairing the fuel, oil, water, vacuum or exhaust systems, check all affected lines for leaks.
- Dispose of drained oil or the solvent used for cleaning parts in an appropriate manner.

### Precautions for Multiport Fuel Injection System or ECCS Engine

- Before connecting or disconnecting multiport fuel injection system or ECM (ECCS control module) harness connector, be sure to turn the ignition switch to the "OFF" position and disconnect the negative battery terminal. Otherwise, there may be damage to ECM.
- Before disconnecting pressurized fuel line from fuel pump to injectors, be sure to release fuel pressure to eliminate danger.
- Be careful not to jar components such as ECM and mass air flow sensor.

### Precautions for Three Way Catalyst

If a large amount of unburned fuel flows into the converter, the converter temperature will be excessively high. To prevent this, follow the procedure below:

1. Use unleaded gasoline only. Leaded gasoline will seriously damage the three way catalyst.
2. When checking for ignition spark or measuring engine compression, make tests quickly and only when necessary.
3. Do not run engine when the fuel tank level is low, otherwise the engine may misfire causing damage to the converter.

Do not place the vehicle on flammable material. Keep flammable material off the exhaust pipe and the three way catalyst.

### Precautions for Turbocharger

The turbocharger turbine revolves at extremely high speeds and becomes very hot. Therefore, it is essential to maintain a clean supply of oil flowing through the turbocharger and to follow all required maintenance instructions and operating procedures.

For proper operation of the system, follow the procedure below.

1. Always use the recommended oil. Follow the instructions for proper time to change the oil and proper oil level.
2. Avoid accelerating engine to a high rpm immediately after starting.
3. If engine had been operating at high rpm for an extended period of time, let it idle for a few minutes prior to shutting it off.

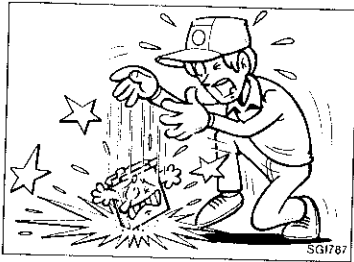

## PRECAUTIONS

### Engine Oils

Prolonged and repeated contact with used engine oil may cause skin cancer. Try to avoid direct skin contact with used oil. If skin contact is made, wash thoroughly with soap or hand cleaner as soon as possible.

### HEALTH PROTECTION PRECAUTIONS

- Avoid prolonged and repeated contact with oils, particularly used engine oils.
- Wear protective clothing, including impervious gloves where practicable.
- Do not put oily rags in pockets.
- Avoid contaminating clothes, particularly underpants, with oil.
- Heavily soiled clothing and oil-impregnated footwear should not be worn. Overalls must be cleaned regularly.
- First Aid treatment should be obtained immediately for open cuts and wounds.
- Use barrier creams, applying them before each work period, to help the removal of oil from the skin.
- Wash with soap and water to ensure all oil is removed (skin cleansers and nail brushes will help). Preparations containing lanolin replace the natural skin oils which have been removed.
- Do not use gasoline, kerosene, diesel fuel, gas oil, thinners or solvents for cleaning skin.
- If skin disorders develop, obtain medical advice without delay.
- Where practicable, degrease components prior to handling.
- Where there is a risk of eye contact, eye protection should be worn, for example, chemical goggles or face shields; in addition an eye wash facility should be provided.

### ENVIRONMENTAL PROTECTION PRECAUTIONS

Burning used engine oil in small space heaters or boilers can be recommended only for units of approved design. The heating system must meet the requirements of HM Inspectorate of Pollution for small burners of less than 0.4 MW. If in doubt check with the appropriate local authority and/or manufacturer of the approved appliance.

Dispose of used oil and used oil filters through authorized waste disposal contractors to licensed waste disposal sites, or to the waste oil reclamation trade. If in doubt, contact the local authority for advice on disposal facilities.

It is illegal to pour used oil on to the ground, down sewers or drains, or into water courses.

**The regulations concerning the pollution of the environment will vary from country to country.**

## PRECAUTIONS

### Precautions for Fuel

Unleaded premium gasoline with an octane rating of at least 95 AKI (Anti-Knock Index) number (Research octane number 96).

#### CAUTION:

Using a fuel other than that specified could adversely affect the emission control devices and systems, and could also affect the warranty coverage validity.

Under no circumstances should a leaded gasoline be used, since this will damage the three way catalyst.

## HOW TO USE THIS MANUAL

- ALPHABETICAL INDEX is provided at the end of this manual so that you can rapidly find the item and page you are searching for.
  - A QUICK REFERENCE INDEX, a black tab (e.g. BR ) is provided on the first page. You can quickly find the first page of each section by mating it to the section's black tab.
  - THE CONTENTS are listed on the first page of each section.
  - THE TITLE is indicated on the upper portion of each page and shows the part or system.
  - THE PAGE NUMBER of each section consists of two letters which designate the particular section and a number (e.g. "BR-5").
  - THE LARGE ILLUSTRATIONS are exploded views (See below) and contain tightening torques, lubrication points, section number of the PARTS CATALOG (e.g. SEC.440) and other information necessary to perform repairs.
- The illustrations should be used in reference to service matters only. When ordering parts, refer to the appropriate PARTS CATALOG.

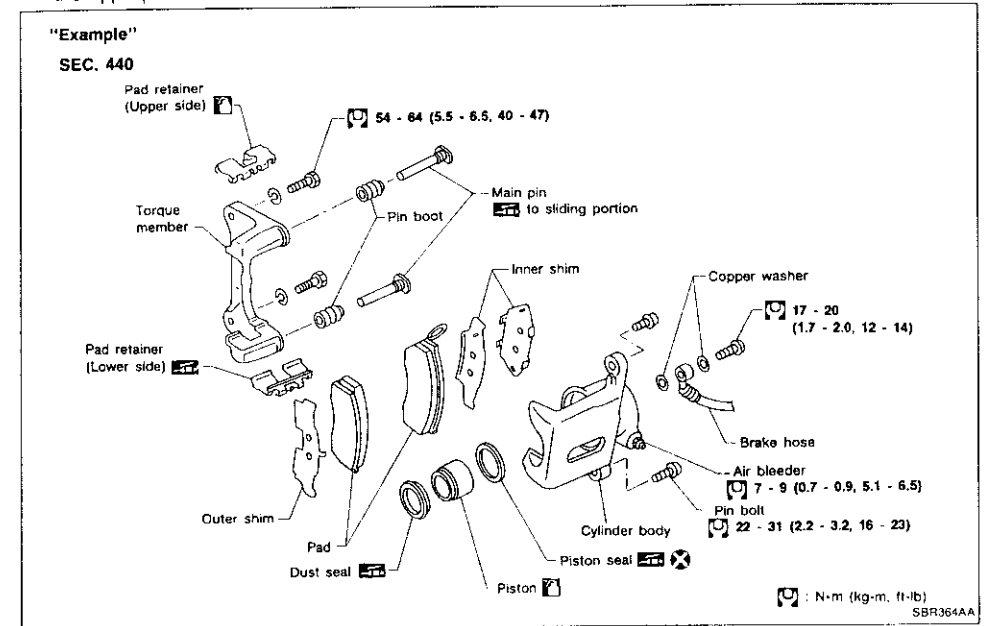

- THE SMALL ILLUSTRATIONS show the important steps such as inspection, use of special tools, knacks of work and hidden or tricky steps which are not shown in the previous large illustrations. Assembly, inspection and adjustment procedures for the complicated units such as the automatic transaxle or transmission, etc. are presented in a step-by-step format where necessary.

## HOW TO USE THIS MANUAL

- The following **SYMBOLS AND ABBREVIATIONS** are used:

	: Tightening torque	M/T	: Manual Transaxle/Transmission
	: Should be lubricated with grease.	A/T	: Automatic Transaxle/Transmission
	Unless otherwise indicated, use recommended multi-purpose grease.	A/C	: Air Conditioner
	: Should be lubricated with oil.	P/S	: Power Steering
	: Sealing point	Tool	: Special Service Tools
	: Checking point	SAE	: Society of Automotive Engineers, Inc.
	: Always replace after every disassembly.	ATF	: Automatic Transmission Fluid
	: Apply petroleum jelly	D <sub>1</sub>	: Drive range 1st gear
	: Apply ATF	D <sub>2</sub>	: Drive range 2nd gear
	: Select with proper thickness.	D <sub>3</sub>	: Drive range 3rd gear
	: Adjustment is required.	D <sub>4</sub>	: Drive range 4th gear
SDS	: Service Data and Specifications	OD	: Overdrive
LH, RH	: Left-Hand, Right-Hand	2 <sub>2</sub>	: 2nd range 2nd gear
FR, RR	: Front, Rear	2 <sub>1</sub>	: 2nd range 1st gear
		1 <sub>2</sub>	: 1st range 2nd gear
		1 <sub>1</sub>	: 1st range 1st gear

- The **UNITS** given in this manual are primarily expressed as the **SI UNIT** (International System of Unit), and alternatively expressed in the metric system and in the yard/pound system.

"Example"

Tightening torque:

59 - 78 N·m (6.0 - 8.0 kg-m, 43 - 58 ft-lb)

- TROUBLE DIAGNOSES** are included in sections dealing with complicated components.
- SERVICE DATA AND SPECIFICATIONS** are contained at the end of each section for quick reference of data.
- The captions **WARNING** and **CAUTION** warn you of steps that must be followed to prevent personal injury and/or damage to some part of the vehicle.
- WARNING** indicates the possibility of personal injury if instructions are not followed.
- CAUTION** indicates the possibility of component damage if instructions are not followed.
- BOLD TYPED STATEMENTS** except **WARNING** and **CAUTION** give you helpful information.

## HOW TO READ WIRING DIAGRAMS

### Sample/Wiring Diagram — EXAMPL —

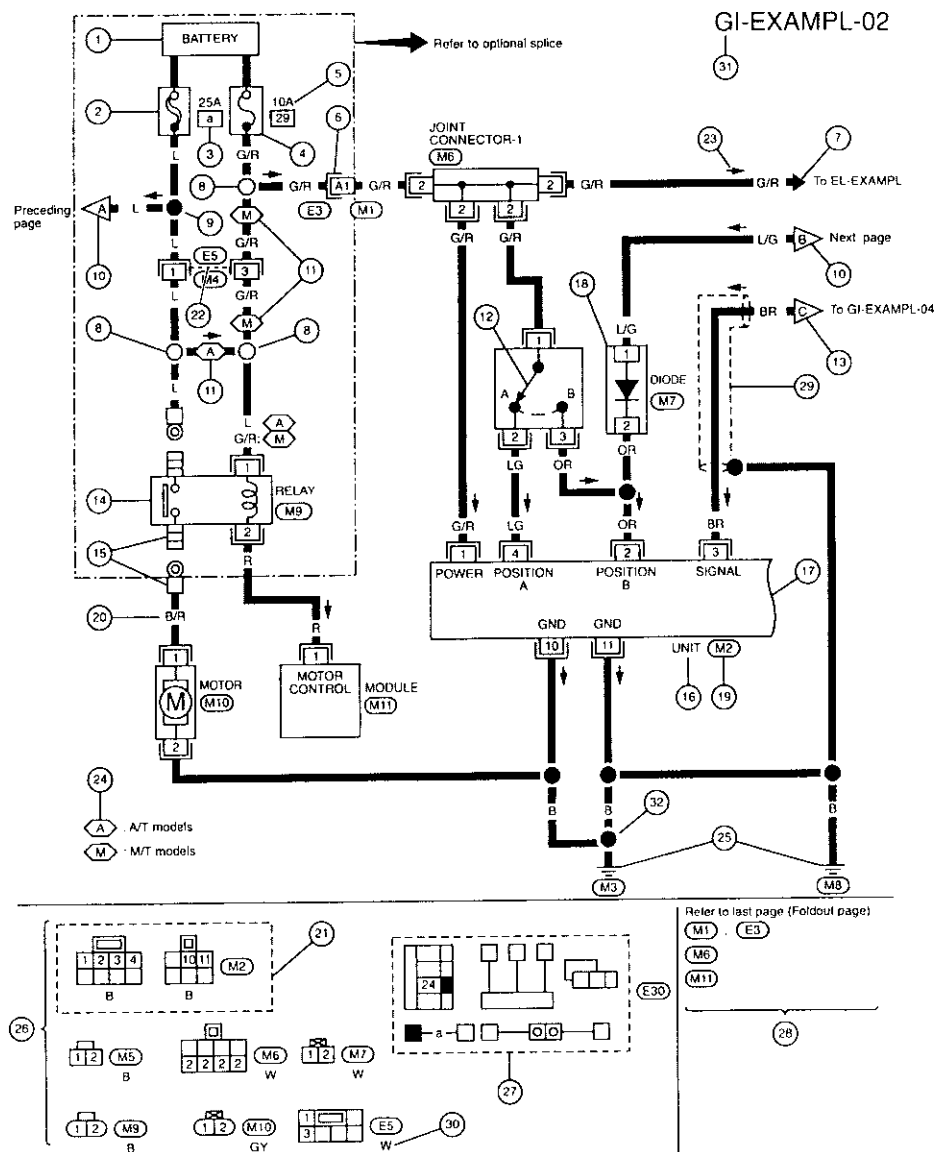

## HOW TO READ WIRING DIAGRAMS

### Sample/Wiring Diagram — EXAMPL — (Cont'd)

#### OPTIONAL SPLICE

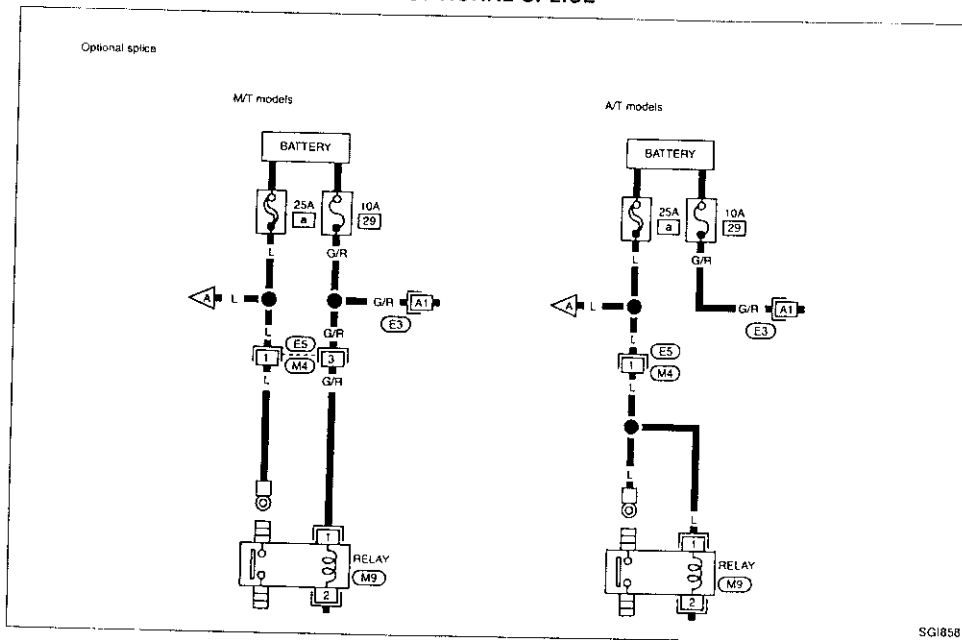

## HOW TO READ WIRING DIAGRAMS

#### Description

Number	Item	Description
1	Power condition	<ul style="list-style-type: none"> <li>This shows the condition when the system receives battery positive voltage (can be operated)</li> </ul>
2	Fusible link	<ul style="list-style-type: none"> <li>The double line shows that this is a fusible link</li> <li>The open circle shows current flow in and the shaded circle shows current flow out.</li> </ul>
3	Fusible link/fuse location	<ul style="list-style-type: none"> <li>This shows the location of the fusible link or fuse in the fusible link or fuse box See "POWER SUPPLY ROUTING" in EL section for arrangement.</li> </ul>
4	Fuse	<ul style="list-style-type: none"> <li>The single line shows that this is a fuse.</li> <li>The open circle shows current flow in and the shaded circle shows current flow out.</li> </ul>
5	Current rating	<ul style="list-style-type: none"> <li>This shows the current rating of the fusible link or fuse</li> </ul>
6	Connectors	<ul style="list-style-type: none"> <li>This shows that connector (E3) is female and connector (M1) is male.</li> <li>The G/R wire is located in the A1 terminal of both connectors</li> <li>Terminal No. with an alphabet (A1, B5, etc.) indicates that the connector is SMJ connector. Refer to GI-16.</li> </ul>
7	System branch	<ul style="list-style-type: none"> <li>This shows that the system branches to another system identified by cell code (section and system)</li> </ul>
8	Optional splice	<ul style="list-style-type: none"> <li>The open circle shows that the splice is optional depending on vehicle application.</li> </ul>
9	Splice	<ul style="list-style-type: none"> <li>The shaded circle shows that the splice is always on the vehicle.</li> </ul>
10	Page crossing	<ul style="list-style-type: none"> <li>This arrow shows that the circuit continues to an adjacent page</li> <li>The A will match with the A on the preceding or next page.</li> </ul>
11	Option abbreviation	<ul style="list-style-type: none"> <li>This shows that the circuit is optional depending on vehicle application.</li> </ul>
12	Switch	<ul style="list-style-type: none"> <li>This shows that continuity exists between terminals 1 and 2 when the switch is in the A position. Continuity exists between terminals 1 and 3 when the switch is in the B position.</li> </ul>
13	Page Crossing	<ul style="list-style-type: none"> <li>This arrow shows that the circuit continues to another page identified by cell code.</li> <li>The C will match with the C on another page within the system other than the next or preceding pages.</li> </ul>
14	Relay	<ul style="list-style-type: none"> <li>This shows an internal representation of the relay. See "STANDARDIZED RELAY" in EL section for details.</li> </ul>
15	Connectors	<ul style="list-style-type: none"> <li>This shows that the connector is connected to the body or a terminal with bolt or nut.</li> </ul>
16	Component name	<ul style="list-style-type: none"> <li>This shows the name of a component.</li> </ul>
17	Component box in wave line	<ul style="list-style-type: none"> <li>This shows that another part of the component is also shown on another page (indicated by wave line) within the system</li> </ul>
18	Assembly parts	<ul style="list-style-type: none"> <li>Connector terminal in component shows that it is a harness incorporated assembly</li> </ul>
19	Connector number	<ul style="list-style-type: none"> <li>This shows the connector number.</li> <li>The letter shows which harness the connector is located</li> <li>Example: M: main harness. See "HARNESS LAYOUT" in EL section to locate the connector A coordinate grid is included for complex harnesses to aid in locating connectors</li> </ul>

# FOREWORD

This manual contains maintenance and repair procedures for the Nissan model S14 series.

In order to assure your safety and the efficient functioning of the vehicle, this manual should be read thoroughly. It is especially important that the PRECAUTIONS in the GI section be completely understood before starting any repair task.

All information in this manual is based on the latest product information at the time of publication. The right is reserved to make changes in specifications and methods at any time without notice.

## IMPORTANT SAFETY NOTICE

The proper performance of service is essential for both the safety of the technician and the efficient functioning of the vehicle.

The service methods in this Service Manual are described in such a manner that the service may be performed safely and accurately.

Service varies with the procedures used, the skills of the technician and the tools and parts available. Accordingly, anyone using service procedures, tools or parts which are not specifically recommended by NISSAN must first completely satisfy himself that neither his safety nor the vehicle's safety will be jeopardized by the service method selected.



NISSAN MOTOR CO., LTD.

Overseas Service Department  
Tokyo, Japan

## GENERAL INFORMATION

# SECTION GI

## CONTENTS

PRECAUTIONS.....	2	HOW TO FOLLOW FLOW CHART IN TROUBLE	
Precautions for Supplemental Restraint System "AIR BAG" and "SEAT BELT PRE-TENSIONER".....	2	DIAGNOSES.....	29
General Precautions.....	2	CONSULT CHECKING SYSTEM.....	32
Precautions for Multipoint Fuel Injection System or ECOS Engine.....	4	Function and System Application.....	32
Precautions for Three Way Catalyst.....	4	Lithium Battery Replacement.....	32
Precautions for Turbocharger.....	4	Checking Equipment.....	32
Engine Oils.....	5	IDENTIFICATION INFORMATION.....	33
Precautions for Fuel.....	6	Model Variation.....	33
HOW TO USE THIS MANUAL.....	7	Identification Number.....	34
HOW TO READ WIRING DIAGRAMS.....	9	Dimensions.....	37
Sample Wiring Diagram — EXAMPL —.....	9	Wheels and Tires.....	37
Description.....	11	LIFTING POINTS AND TOW TRUCK TOWING.....	38
Wiring Diagram Codes (Cell Codes).....	17	Garage Jack and Safety Stand.....	38
HOW TO PERFORM EFFICIENT DIAGNOSIS FOR AN ELECTRICAL INCIDENT.....	18	2-pole Lift.....	39
Work Flow.....	18	Preparation.....	39
Incident Simulation Tests.....	19	Board-on Lift.....	39
Circuit Inspection.....	23	Tow Truck Towing.....	40
		TIGHTENING TORQUE OF STANDARD BOLTS.....	41
		SAE J1930 TERMINOLOGY LIST.....	42
		SAE J1930 Terminology List.....	42

GI

MA

EM

LC

EC

FE

CL

MT

AT

PD

FA

RA

BR

ST

RS

BT

HA

EL

DX

## HOW TO READ WIRING DIAGRAMS

### Description (Cont'd)

Number	Item	Description																
20	Wire color	<ul style="list-style-type: none"> <li>This shows a code for the color of the wire.</li> </ul> <table border="0"> <tr> <td>B = Black</td> <td>BR = Brown</td> </tr> <tr> <td>W = White</td> <td>OR = Orange</td> </tr> <tr> <td>R = Red</td> <td>P = Pink</td> </tr> <tr> <td>G = Green</td> <td>PU = Purple</td> </tr> <tr> <td>L = Blue</td> <td>GY = Gray</td> </tr> <tr> <td>Y = Yellow</td> <td>SB = Sky Blue</td> </tr> <tr> <td>LG = Light Green</td> <td>CH = Dark Brown</td> </tr> <tr> <td></td> <td>DG = Dark Green</td> </tr> </table> <p>When the wire color is striped, the base color is given first, followed by the stripe color as shown below: Example: L/W = Blue with White Stripe</p>	B = Black	BR = Brown	W = White	OR = Orange	R = Red	P = Pink	G = Green	PU = Purple	L = Blue	GY = Gray	Y = Yellow	SB = Sky Blue	LG = Light Green	CH = Dark Brown		DG = Dark Green
B = Black	BR = Brown																	
W = White	OR = Orange																	
R = Red	P = Pink																	
G = Green	PU = Purple																	
L = Blue	GY = Gray																	
Y = Yellow	SB = Sky Blue																	
LG = Light Green	CH = Dark Brown																	
	DG = Dark Green																	
21	Common component	<ul style="list-style-type: none"> <li>Connectors enclosed in broken line show that those belong to the same component.</li> </ul>																
22	Common connector	<ul style="list-style-type: none"> <li>The dotted lines between terminals show that these terminals are part of the same connector.</li> </ul>																
23	Current flow arrow	<ul style="list-style-type: none"> <li>Arrow indicates electric current flow, especially where the direction of standard flow (vertically downward or horizontally from left to right) is difficult to follow.</li> <li>A double arrow "◄ ►" shows that current can flow in either direction depending on circuit operation.</li> </ul>																
24	Option description	<ul style="list-style-type: none"> <li>This shows a description of the option abbreviation used on the page.</li> </ul>																
25	Ground	<ul style="list-style-type: none"> <li>This shows the ground connection.</li> </ul>																
26	Connector views	<ul style="list-style-type: none"> <li>This area shows the connector faces of the components in the wiring diagram on the page.</li> </ul>																
27	Fusible link and fuse box	<ul style="list-style-type: none"> <li>This shows the arrangement of fusible link(s) and fuse(s), used for connector views of POWER SUPPLY ROUTING in "EL" section.</li> <li>The open square shows current flow in, and the shaded square shows current flow out. Same meanings as the open and shaded circles in Number 2 and 4 above.</li> </ul>																
28	Reference	<ul style="list-style-type: none"> <li>This shows that more information on the Super Multiple Junction (SMJ) and joint connectors exists. See Foldout Page in EL section for details.</li> </ul>																
29	Shielded line	<ul style="list-style-type: none"> <li>The line enclosed by broken line circle shows shield wire.</li> </ul>																
30	Connector color	<ul style="list-style-type: none"> <li>This shows the code for the color of the connector. For code meaning, refer to wire color codes above (20).</li> </ul>																
31	Cell code	<ul style="list-style-type: none"> <li>This identifies each page of the wiring diagram by section, system and wiring diagram page number.</li> </ul>																
32	Ground	<ul style="list-style-type: none"> <li>The line spliced and grounded under wire color shows that ground line is spliced at the grounded connector.</li> </ul>																

## HOW TO READ WIRING DIAGRAMS

### Description (Cont'd)

#### CONNECTOR SYMBOLS

Most of connector symbols in wiring diagrams are shown from the terminal side.

- Connector symbols shown from the terminal side are enclosed by a single line.
- Connector symbols shown from the harness side are enclosed by a double line and followed by the direction mark

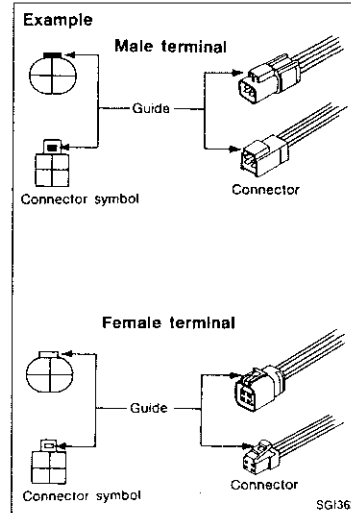
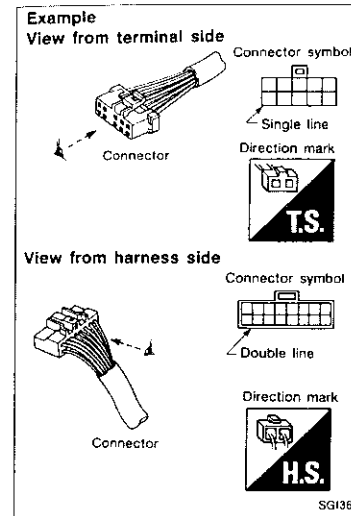

- Male and female terminals
- Connector guides for male terminals are shown in black and female terminals in white in wiring diagrams.



## HOW TO READ WIRING DIAGRAMS

### Description (Cont'd)

#### SWITCH POSITIONS

Switches are shown in wiring diagrams as if the vehicle is in the "normal" condition.

A vehicle is in the "normal" condition when:

- ignition switch is "OFF",
- doors, hood and trunk lid/back door are closed,
- pedals are not depressed, and
- parking brake is released.

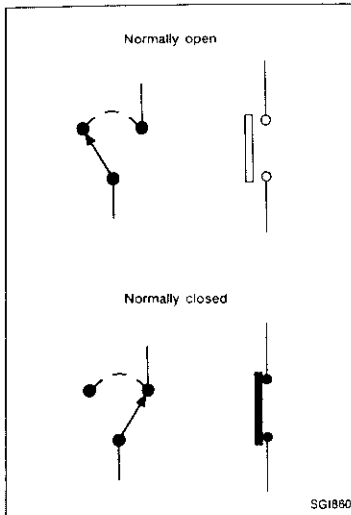

SG1890

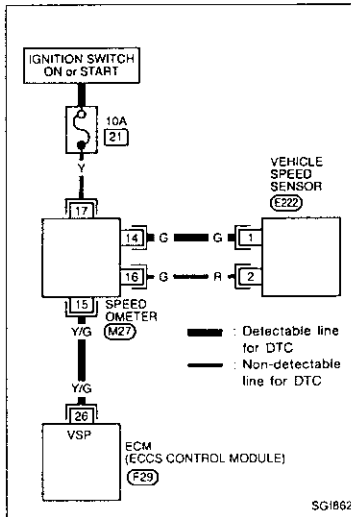

SG1892

#### DETECTABLE LINES AND NON-DETECTABLE LINES

In some wiring diagrams, two kinds of lines, representing wires, with different weight are used.

- A line with regular weight (wider line) represents a "detectable line for DTC (Diagnostic Trouble Code)". A "detectable line for DTC" is a circuit in which ECM (ECSS control module) can detect its malfunctions with the on-board diagnostic system.
- A line with less weight (thinner line) represents a "non-detectable line for DTC". A "non-detectable line for DTC" is a circuit in which ECM cannot detect its malfunctions with the on-board diagnostic system.

## HOW TO READ WIRING DIAGRAMS

### Description (Cont'd)

#### MULTIPLE SWITCH

The continuity of multiple switch is described in two ways as shown below.

- The switch chart is used in schematic diagrams.
- The switch diagram is used in wiring diagrams.

#### Example

(SWITCH CHART)

WIPER SWITCH		OFF	INT	LO	HI	WASH
1						○
2				○		
3	○					
4	○	○	○	○	○	
5						○
6						○

(SWITCH DIAGRAM)

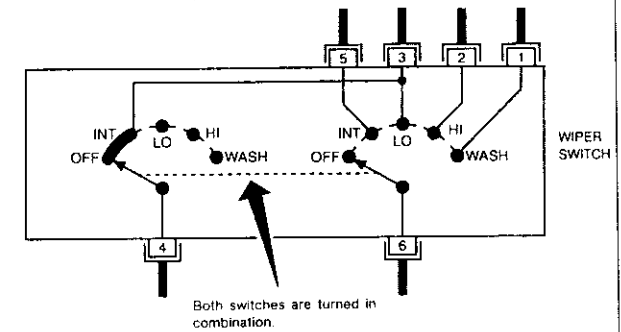

Continuity circuit of wiper switch

SWITCH POSITION	CONTINUITY CIRCUIT
OFF	3 - 4
INT	3 - 4, 5 - 6
LO	3 - 6
HI	2 - 6
WASH	1 - 6

SG1875

## HOW TO READ WIRING DIAGRAMS

### Description (Cont'd)

#### FOLDOUT PAGE

The foldout should be spread to read the entire wiring diagram.

#### Super multiple junction (SMJ)

In wiring diagram, connectors consisting of terminals having terminal numbers with an alphabet (B1, D0, etc.) are SMJ connectors.

If connector numbers are shown in Reference Area, these connector symbols are not shown in Connector Area. For terminal arrangement of these connectors, refer to the fold-out page at the end of this manual.

#### Joint connector

Joint connector symbols are shown in Connector Area in the wiring diagram concerned. Fold-out page also carries inside wiring layout together with such joint connector symbols.

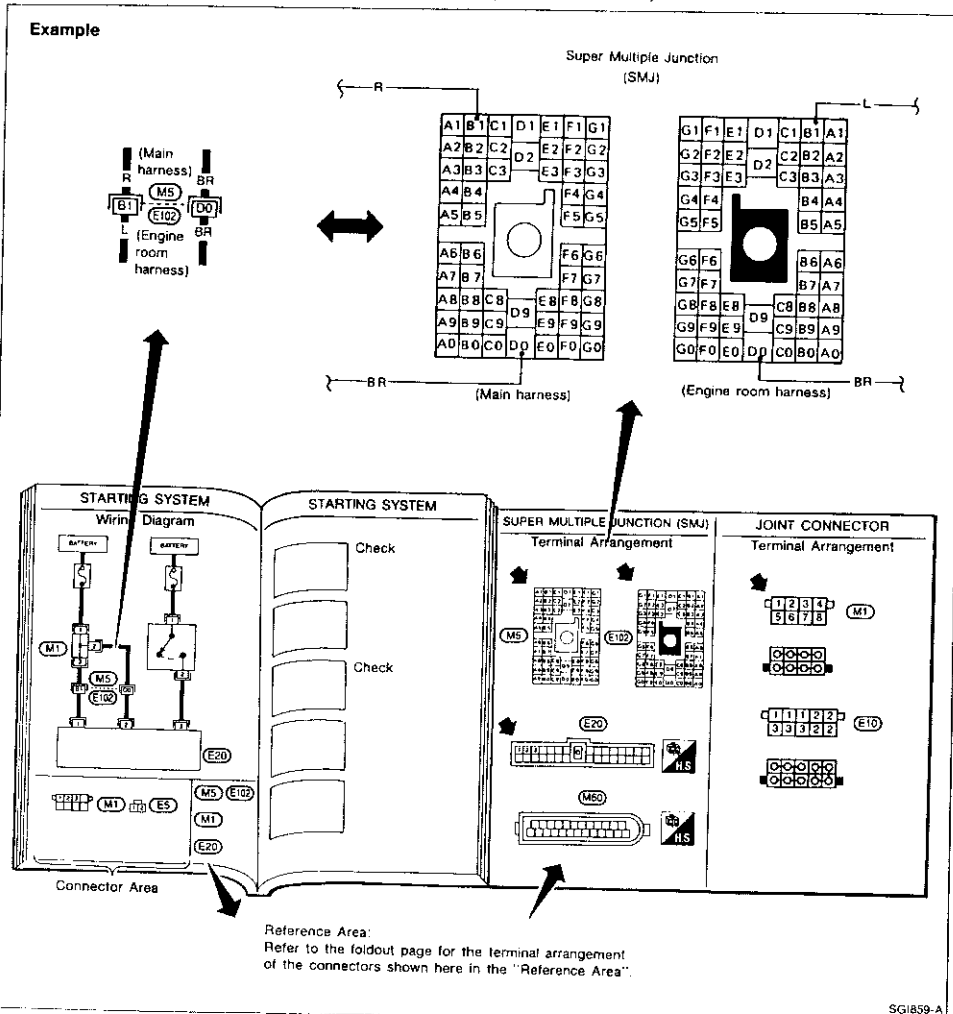

## HOW TO READ WIRING DIAGRAMS

### Wiring Diagram Codes (Cell Codes)

Use the chart below to find out what each wiring diagram code stands for.

Code	Section	Wiring Diagram Name
AAC/V	EC	IACV-AAC Valve
ABS	BR	Anti-lock Brake System
A/C, A	HA	Auto Air Conditioner
A/C, M	HA	Manual Air Conditioner
A/T	AT	Automatic Transmission
AIM	EL	Headlamp System
AT/C	EC	A/T Control
AUDIO	EL	Audio
BACK/L	EL	Back-up Lamp
BOOST	EC	Boost Pressure Sensor
CHARGE	EL	Charging System
CHIME	EL	Warning Chime
CMPS	EC	Camshaft Position Sensor
COOL/F	EC	Cooling Fan Control
DEF	EL	Rear Window Defogger
DEF/S	EC	Rear Window Defogger Signal
DIFF	PD	Differential Oil Cooler
D/LOCK	EL	Power Door Lock
DTRL	EL	Headlamp - With Daytime Light System
ECTS	EC	Engine Coolant Temperature Sensor
EGRC/V	EC	EGR and canister Control Solenoid Valve
F/FOG	EL	Front Fog Lamp
FICD	EC	IACV-FICD Solenoid Valve
F/PUMP	EC	Fuel Pump
H/LAMP	EL	Headlamp—Without Daytime Light System
H/SEAT	EL	Heated Seat
HEAT	HA	Heater
HLC	EL	Headlamp Washer
HO2S	EC	Heated Oxygen Sensor
HORN	EL	Horn, Cigarette Lighter, Clock
IGN/SG	EC	Ignition Signal
ILL	EL	Illumination
INJECT	EC	Injector
INT/L	EL	Interior, Spot and Trunk Room Lamps
KS	EC	Knock Sensor

Code	Section	Wiring Diagram Name
MAFS	EC	Mass Air Flow Sensor
MAIN	EC	Main Power Supply and Ground Circuit
METER	EL	Speedometer, Tachometer, Temp and Fuel Gauges
MIL	EC	MIL, Data Link Connector For Consult
MIRROR	EL	Door Mirror
MULTI	EL	Multi-remote Control System
P/ANT	EL	Power Antenna
PNP/SW	EC	Park/Neutral Position Switch
POWER	EL	Power Supply Routing
PST/SW	EC	Power Steering Oil Pressure Switch
R/FOG	EL	Rear Fog Lamp
SROOF	EL	Sun Roof
SRS	RS	Supplemental Restraint System
S/SIG	EC	Start Signal
START	EL	Starting System
STOP/L	EL	Stop Lamp
TAIL/L	EL	Clearance, License, and Tail Lamps
THEFT	EL	Theft Warning System
TPS	EC	Throttle Position Sensor
TURN	EL	Turn Signal and Hazard Warning Lamps
VSS	EC	Vehicle Speed Sensor
VTC	EC	VTC Solenoid Valve
WARN	EL	Warning Lamps
WG/V	EC	Wastegate Valve Control Solenoid Valve
WINDOW	EL	Power Window
WIPER	EL	Front Wiper and Washer
WIP/R	EL	Rear Wiper and Washer

Work Flow

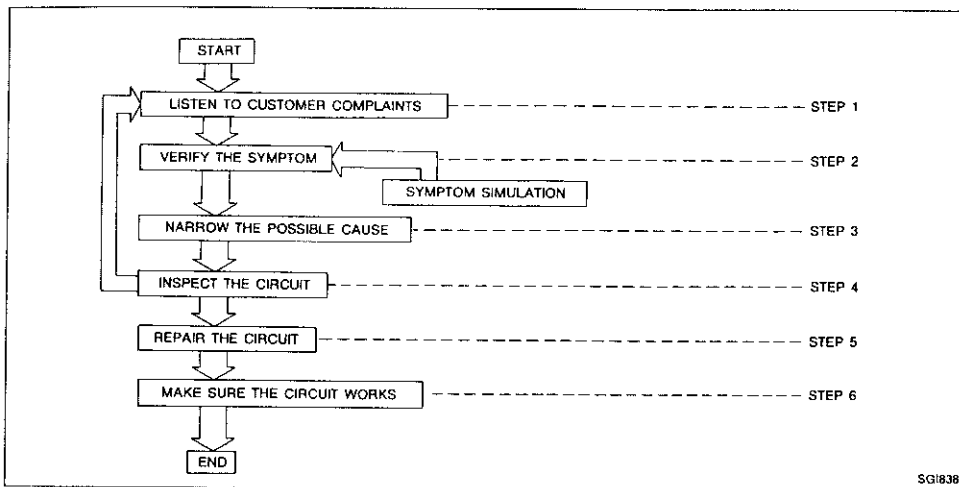

SG1838

STEP	DESCRIPTION
STEP 1	Get detailed information about the conditions and the environment when the incident occurred. The following are key pieces of information required to make a good analysis:  <b>WHAT</b> Vehicle Model, Engine, Transmission and the System (i.e. Radio). <b>WHEN</b> Date, Time of Day, Weather Conditions, Frequency. <b>WHERE</b> Road Conditions, Altitude and Traffic Situation. <b>HOW</b> System Symptoms, Operating Conditions (Other Components Interaction). Service History and if any After Market Accessories have been installed.
STEP 2	Operate the system, road test if necessary. Verify the parameter of the incident. If the problem can not be duplicated, refer to "Incident Simulation Tests" next page.
STEP 3	Get the proper diagnosis materials together including:  POWER SUPPLY ROUTING System Operation Descriptions Applicable Service Manual Sections  Identify where to begin diagnosis based upon your knowledge of the system operation and the customer comments.
STEP 4	Inspect the system for mechanical binding, loose connectors or wiring damage. Determine which circuits and components are involved and diagnose using the Power Supply Routing and Harness Layouts.
STEP 5	Repair or replace the incident circuit or component.
STEP 6	Operate the system in all modes. Verify the system works properly under all conditions. Make sure you have not inadvertently created a new incident during your diagnosis or repair steps.

Incident Simulation Tests

INTRODUCTION

Sometimes the symptom is not present when the vehicle is brought in for service. Therefore, it is necessary to simulate the conditions and environment when the incident occurred. Otherwise, only a No Trouble Found Diagnosis may be found. The following section illustrates ways to simulate the conditions/environment under which the owner experiences an electrical incident.

The section is broken into the six following topics:

1. Vehicle vibration
2. Heat sensitive
3. Freezing
4. Water intrusion
5. Electrical load
6. Cold or hot start up

Get a thorough description of the incident from the customer. It is important for simulating the conditions of the problem.

VEHICLE VIBRATION

The problem may occur or become worse while driving on a rough road or when engine is vibrating (idle with A/C on). In such a case, you will want to check for a vibration related condition. Refer to the illustration below.

Connectors & harness

Determine which connectors and wiring harness would affect the electrical system you are inspecting. Gently shake each connector and harness while monitoring the system for the incident you are trying to duplicate. This test may indicate a loose or poor electrical connection.

Hint

Connectors can be exposed to moisture. It is possible to get a thin film of corrosion on the connector terminals. A visual inspection may not reveal this without disconnecting the connector. If the problem occurs intermittently, perhaps the problem is caused by corrosion. It is a good idea to disconnect, inspect and clean the terminals on related connectors in the system.

Sensors & relays

Gently apply a slight vibration to sensors and relays in the system you are inspecting. This test may indicate a loose or poorly mounted sensor or relay.

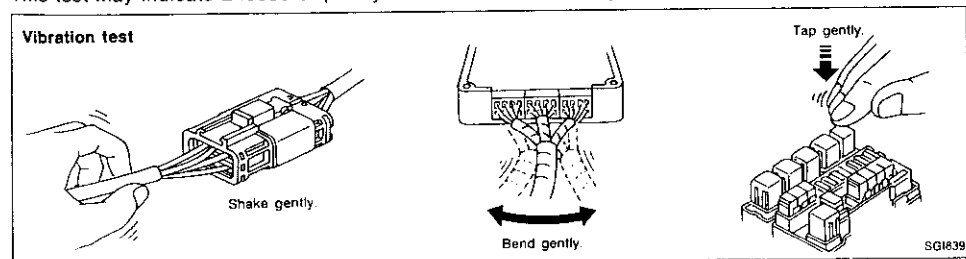

SG1839

GI  
MA  
EM  
LC  
EC  
FE  
CL  
MT  
AT  
PD  
FA  
RA  
BR  
ST  
RS  
BT  
HA  
EL  
DX

## HOW TO PERFORM EFFICIENT DIAGNOSIS FOR AN ELECTRICAL INCIDENT

### Incident Simulation Tests (Cont'd)

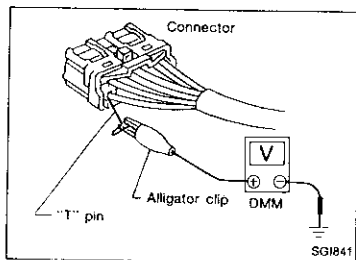
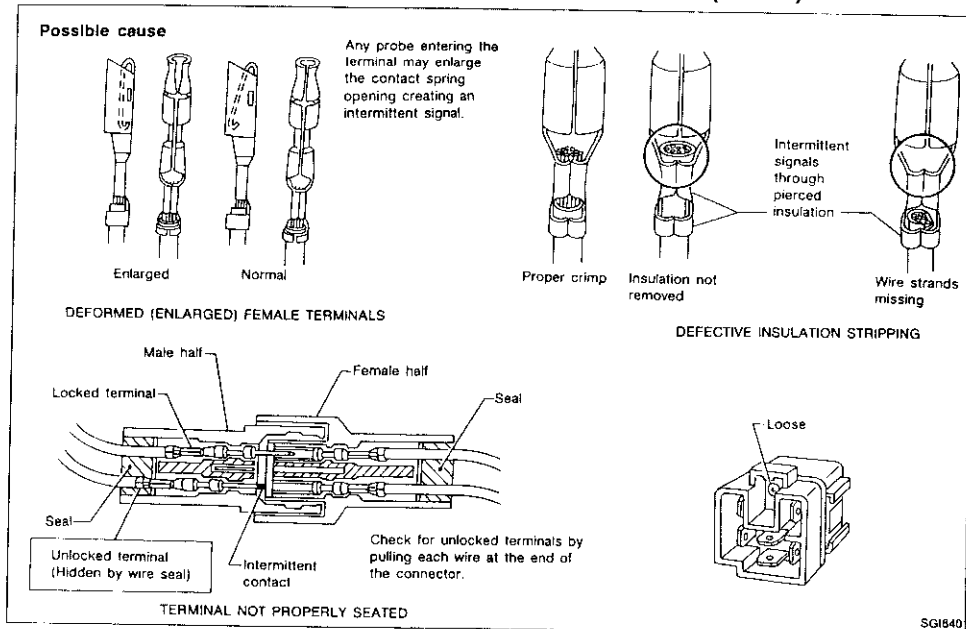

#### Tester probe

When probing a connector it is possible to enlarge the contact spring opening. If this occurs it may create an intermittent signal in the circuit. When probing a connector, use care not to enlarge the opening. The probe of the Digital Multimeter (DMM) may not fit into the connector cavity. In such cases make an extension of a "T" pin and probe it from the harness side of the connector. Most DMMs have accessory alligator clips. Slide these over the probe to allow clipping the "T" pin for a better contact. If you have any difficulty probing a terminal, inspect the terminal. Ensure you have not accidentally opened the contact spring or pulled a wire loose.

## HOW TO PERFORM EFFICIENT DIAGNOSIS FOR AN ELECTRICAL INCIDENT

### Incident Simulation Tests (Cont'd)

#### Engine compartment

There are several reasons a vehicle or engine vibration could cause an electrical complaint. Some of the things to check for are:

- Connectors which are inaccessible for diagnosis probing.
- Connectors which may not fully be seated.
- Wiring harness which are not long enough and are being stressed during engine vibrations or rocking.
- Wires laying across brackets or moving components.
- Loose, dirty or corroded ground wires.
- Wires routed too close to hot components.

To inspect components under the hood, start by verifying the integrity of ground connections. (Refer to GROUND INSPECTION described later.) First check that the system is properly grounded. Then check for loose connection by **gently shaking** the wiring or components as previously explained. Using the wiring diagrams inspect the wiring for continuity.

#### Behind the instrument panel

Improperly routed or improperly clamped harness can become pinched during accessory installation. Vehicle vibration can aggravate a harness which is routed along a bracket or near a screw behind or below the dash.

#### Under seating areas

An unclamped or loose harness can cause wiring to be pinched by seat components (such as slide guides) during vehicle vibration. If the wiring runs under seating areas inspect wire routing for possible damage or pinching.

#### HEAT SENSITIVE

The owner's problem may occur during hot weather or after car has sat for a short time. In such cases you will want to check for a heat sensitive condition.

To determine if an electrical component is heat sensitive, heat the component with a heat gun or equivalent.

**Do not heat components above 60°C (140°F).** If incident occurs while heating the unit, either replace or properly insulate the component.

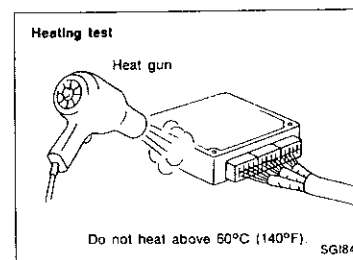

# MAINTENANCE

# SECTION MA

## CONTENTS

<b>PRECAUTIONS AND PREPARATION</b> .....	2	<b>CHASSIS AND BODY MAINTENANCE</b> .....	19
Supplemental Restraint System (SRS) "AIR BAG" and "SEAT BELT PRE-TENSIONER".....	2	Checking Exhaust System.....	19
Special Service Tools.....	2	Checking Clutch Fluid Level and Leaks.....	19
Commercial Service Tool.....	2	Checking Clutch System.....	19
<b>PRE-DELIVERY INSPECTION ITEMS</b> .....	3	Checking M/T Oil.....	19
<b>GENERAL MAINTENANCE</b> .....	4	Changing M/T Oil.....	19
<b>PERIODIC MAINTENANCE (Except for Europe)</b> .....	5	Checking A/T Fluid.....	20
<b>PERIODIC MAINTENANCE (For Europe)</b> .....	7	Changing A/T Fluid.....	20
<b>RECOMMENDED FLUIDS AND LUBRICANTS</b> .....	10	Checking Propeller Shaft.....	20
Fluids and Lubricants.....	10	Checking Differential Gear Oil.....	21
SAE Viscosity Number.....	11	Changing Differential Gear Oil.....	21
<b>ENGINE MAINTENANCE</b> .....	12	Balancing Wheels.....	21
Checking Drive Belts.....	12	Tire Rotation.....	21
Changing Engine Coolant.....	12	Checking Brake Fluid Level and Leaks.....	21
Checking Cooling System.....	13	Checking Brake Lines and Cables.....	21
Checking Fuel Lines.....	14	Changing Brake Fluid.....	22
Changing Fuel Filter.....	14	Checking Brake Booster, Vacuum Hoses, Connections and Check Valve.....	22
Changing Air Cleaner Filter.....	15	Checking Disc Brake.....	22
Changing Engine Oil.....	15	Checking Steering Gear and Linkage.....	23
Changing Oil Filter.....	16	Checking Power Steering Fluid and Lines.....	23
Changing Spark Plugs.....	16	Lubricating Locks, Hinges and Hood Latches.....	24
Checking Positive Crankcase Ventilation (PCV) System.....	17	Checking Seat Belts, Buckles, Retractors, Anchors and Adjusters.....	24
Checking Vacuum Hoses and Connections.....	17	<b>SERVICE DATA AND SPECIFICATIONS (SDS)</b> .....	25
Checking Vapor Lines.....	17	Engine Maintenance.....	25
Checking Heated Oxygen Sensor (HO2S).....	18	Chassis and Body Maintenance.....	25

GI

MA

EM

LC

EC

FE

CL

MT

AT

PD

FA

RA

BR

ST

RS

BT

HA

EL

IDX

## PRECAUTIONS AND PREPARATION



### Supplemental Restraint System (SRS) "AIR BAG" and "SEAT BELT PRE-TENSIONER"

The Supplemental Restraint System "Air Bag" and "Seat belt pre-tensioner", used along with a seat belt, help to reduce the risk or severity of injury to the driver and front passenger in a frontal collision. The Supplemental Restraint System consists of air bag modules (located in the center of the steering wheel and on the instrument panel on the passenger side), seat belt pre-tensioner, a diagnosis sensor unit, warning lamp, wiring harness and spiral cable. Information necessary to service the system safely is included in the RS section of this Service Manual.

#### WARNING:

- To avoid rendering the SRS inoperative, which could increase the risk of personal injury or death in the event of a collision which would result in air bag inflation, all maintenance must be performed by an authorized NISSAN dealer.
- Improper maintenance, including incorrect removal and installation of the SRS, can lead to personal injury caused by unintentional activation of the system.
- All SRS electrical wiring harnesses and connectors are covered with yellow outer insulation. Do not use electrical test equipment on any circuit related to the SRS.

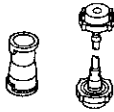
### Special Service Tools

Tool number Tool name	Description
EG17650301 Radiator cap tester adapter	 NT053
KV10115800 Oil filter wrench 65 mm (2.56 in) dia.	 NT006

### Commercial Service Tool

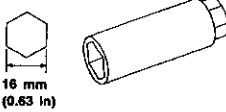
Tool name	Description
Spark plug wrench	 16 mm (0.63 in) Wrench with a magnet to hold spark plug NT047

## PRE-DELIVERY INSPECTION ITEMS

Shown below are Pre-delivery Inspection Items required for the new vehicle. It is recommended that necessary items other than those listed here be added, paying due regard to the conditions in each country.

Perform applicable items on each model. Consult text of this section for specifications.

### UNDER HOOD — engine off

- Radiator coolant level and coolant hose connections for leaks
- Battery fluid level, specific gravity and conditions of battery terminals
- Drive belts tension
- Fuel filter for water or dusts, and fuel lines and connections for leaks
- Engine oil level and oil leaks
- Clutch and brake reservoir fluid level and fluid lines for leaks
- Windshield and rear window washer and headlamp cleaner reservoir fluid level
- Power steering reservoir fluid level and hose connections for leaks

### ON INSIDE AND OUTSIDE

- Remove front spring/strut spacer (If applicable)
- Operation of all instruments, gauges, lights and accessories
- Operation of horn(s), wiper and washer
- Steering lock for operation
- Check air conditioner for gas leaks
- Front and rear seats, and seat belts for operation
- All moldings, trims and fittings for fit and alignment
- All windows for operation and alignment
- Hood, trunk lid, door panels for fit and alignment
- Latches, keys and locks for operation
- Weatherstrips for adhesion and fit
- Headlamp aiming
- Tighten wheel nuts (Inc. inner nuts if applicable)
- Tire pressure (Inc. spare tire)
- Check front wheels for toe-in
- Install clock/voltmeter/room lamp fuse (If applicable)
- Install deodorizing filter to air purifier (If applicable)
- Remove wiper blade protectors (If applicable)

### UNDER BODY

- Manual transmission/transaxle and differential gear oil level
- Brake and fuel lines and oil/fluid reservoirs for leaks
- Tighten bolts and nuts of steering linkage and gear box, suspension, propeller shafts and drive shafts
- Tighten rear body bolts and nuts (Models with wooden bed only)

### ROAD TEST

- Clutch operation
- Parking brake operation
- Service brake operation
- Automatic transmission/transaxle shift timing and kickdown
- Steering control and returnability
- Engine performance
- Squeaks and rattles

### ENGINE OPERATING AND HOT

- Adjust idle mixture and speed (and ignition timing\*1)
- Automatic transmission/transaxle fluid level
- Engine idling and stop knob operation (Diesel only)

### FINAL INSPECTION

- Install necessary parts (outside mirror, wheel covers, seat belts, mat, carpet or mud flaps)
- Inspect for interior and exterior metal and paint damage
- Check for spare tire, jack, tools (wheel chock), and literature
- Wash, clean interior and exterior

\*1: Not required on models with a direct ignition system

⊗: Not applicable on this model

## GENERAL MAINTENANCE

General maintenance includes those items which should be checked during the normal day-to-day operation of the vehicle. They are essential if the vehicle is to continue operating properly. The owners can perform the checks and inspections themselves or they can have their NISSAN dealers do them for a nominal charge.

Item	Reference pages
<b>OUTSIDE THE VEHICLE</b>	
The maintenance items listed here should be performed from time to time, unless otherwise specified.	
<b>Tires</b> Check the pressure with a gauge periodically when at a service station, including the spare, and adjust to the specified pressure if necessary. Check carefully for damage, cuts or excessive wear.	—
<b>Windshield wiper blades</b> Check for cracks or wear if they do not wipe properly.	—
<b>Doors and engine hood</b> Check that all doors, the engine hood, the trunk lid and back door operate properly. Also ensure that all latches lock securely. Lubricate if necessary. Make sure that the secondary latch keeps the hood from opening when the primary latch is released. When driving in areas using road salt or other corrosive materials, check for lubrication frequently.	MA-24
<b>Tire rotation</b> Tires should be rotated every 10,000 km (6,000 miles).	MA-21
<b>INSIDE THE VEHICLE</b>	
The maintenance items listed here should be checked on a regular basis, such as when performing periodic maintenance, cleaning the vehicle etc.	
<b>Lights</b> Make sure that the headlights, stop lights, tail lights, turn signal lights, and other lights are all operating properly and installed securely. Also check headlight aim.	—
<b>Warning lights and chimes</b> Make sure that all warning lights and chimes are operating properly.	—
<b>Steering wheel</b> Check for change in the steering conditions, such as excessive free play, hard steering or strange noises. <b>Free play: Less than 35 mm (1.38 in)</b>	—
<b>Seat belts</b> Check that all parts of the seat belt system (e.g. buckles, anchors, adjusters and retractors) operate properly and smoothly, and are installed securely. Check the belt webbing for cuts, fraying, wear or damage.	MA-24
<b>UNDER THE HOOD AND VEHICLE</b>	
The maintenance items listed here should be checked periodically e.g. each time you check the engine oil or refuel.	
<b>Windshield washer fluid</b> Check that there is adequate fluid in the tank.	—
<b>Engine coolant level</b> Check the coolant level when the engine is cold.	MA-12
<b>Engine oil level</b> Check the level after parking the vehicle on a level spot and turning off the engine.	MA-15
<b>Brake and clutch fluid level</b> Make sure that the brake and clutch fluid level is between the "MAX" and "MIN" lines on the reservoir.	MA-19, 21
<b>Battery</b> Check the fluid level in each cell. It should be between the "MAX" and "MIN" lines.	—

## PERIODIC MAINTENANCE (Except for Europe)

The following tables show the normal maintenance schedule. Depending upon weather and atmospheric conditions, varying road surfaces, individual driving habits and vehicle usage, additional or more frequent maintenance may be required.

Periodic maintenance beyond the last period shown on the tables requires similar maintenance.

MAINTENANCE OPERATION	MAINTENANCE INTERVAL										Reference page
	km x 1,000	10	20	30	40	50	60	70	80		
	(Miles x 1,000)	(0.6)	(6)	(12)	(18)	(24)	(30)	(36)	(42)	(48)	
Perform either at number of kilometers (miles) or months, whichever comes first	Months	—	6	12	18	24	30	36	42	48	
<b>ENGINE AND EMISSION CONTROL Underhood and under vehicle</b>											
Check drive belts for cracks, fraying, wear & tension					X						MA-12
Change engine anti-freeze coolant (Ethylene glycol base) (LLC)					X						MA-12
Check cooling system			X		X		X		X		MA-13
Check fuel lines					X				X		MA-14
Replace air cleaner filter (Viscous paper type)*					X				X		MA-15
Change engine oil (Use API SE, SF, SG or SH oil)*			Every 5,000 km (3,000 miles) or 6 months								MA-15
Change engine oil filter* (Use Part No. 15208-65F00)		X	X	X	X	X	X	X	X	X	MA-16
Replace fuel filter*					X				X		MA-15
Replace spark plugs (Use PLATINUM-TIPPED type)					Every 100,000 km (60,000 miles)						MA-16
Check vapor lines and heated oxygen sensor					X				X		MA-17, 18
<b>CHASSIS AND BODY Underhood</b>											
Check brake, clutch & automatic transmission fluid level & leaks*		X	X	X	X	X	X	X	X	X	MA-19, 20, 21
Change brake fluid*					X				X		MA-22
Check brake booster vacuum hoses, connections & check valve					X				X		MA-22
Check power steering fluid & lines		X	X	X	X	X	X	X	X	X	MA-23
<b>Under vehicle</b>											
Check brake, clutch & exhaust systems for proper attachment, leaks, cracks, chafing, abrasion, deterioration, etc.		X	X	X	X	X	X	X	X	X	MA-19, 21
Check oil level in manual transmission & differential gear*		X	X	X	X	X	X	X	X	X	MA-19, 21
Check steering gear & linkage, axle & suspension parts & propeller shaft & drive shaft for damaged, loose & missing parts & lubrication*		X		X		X		X		X	MA-20, 23 FA-5, RA-5, 7
<b>Outside and inside</b>											
Check wheel alignment. If necessary, rotate & balance wheels			X		X		X		X		MA-21 FA-6
Check brake pads, discs & other brake components for wear, deterioration & leaks*		X	X	X	X	X	X	X	X	X	MA-22
Lubricate locks, hinges & hood latch*		X	X	X	X	X	X	X	X	X	MA-24
Check seat belts, buckles, retractors, anchors & adjuster			X		X		X		X		MA-24
Check foot brake, parking brake & clutch for free play, stroke & operation		X	X	X	X	X	X	X	X	X	CL-4, BR-7, 23
Air bag system					See NOTE (1).						RS-5

NOTE: (1) Inspect at the first 10 years and then every 2 years.  
(2) Maintenance items with "\*" should be performed more frequently according to "Maintenance under severe driving conditions".

Check: Check. Correct or replace if necessary.

## PERIODIC MAINTENANCE (Except for Europe)

### MAINTENANCE UNDER SEVERE DRIVING CONDITIONS

The maintenance intervals shown on the preceding pages are for normal operating conditions. If the vehicle is mainly operated under severe driving conditions as shown below, more frequent maintenance must be performed on the following items as shown in the table.

#### Severe driving conditions

- A — Driving under dusty conditions
- B — Driving repeatedly short distances
- C — Towing a trailer
- D — Extensive idling
- E — Driving in extremely adverse weather conditions or in areas where ambient temperatures are either extremely low or extremely high
- F — Driving in high humidity areas or in mountainous areas
- G — Driving in areas using salt or other corrosive materials
- H — Driving on rough and/or muddy roads or in the desert
- I — Driving with frequent use of braking or in mountainous areas

Driving condition	Maintenance item	Maintenance operation	Maintenance interval	Reference page
A . . . . .	Air cleaner filter	Replace		MA-15
A B C D . . . . .	Engine oil	Replace	More frequently	MA-15
A B C D . . . . .	Engine oil filter	Replace	Every 5,000 km (3,000 miles) or 3 months	MA-16
A . . . . . E . . . . .	Fuel filter	Replace	Every 20,000 km (12,000 miles) or 12 months	MA-21
. . . . . F . . . . .	Brake fluid	Replace		
. . . . . C . . . . . H . . . . .	Automatic & manual transmission oil & differential gear oil	Replace	Every 40,000 km (24,000 miles) or 24 months	MA-19, 20, 21
. . . . . G H . . . . .	Steering gear & linkage, axle & suspension parts & propeller shaft & drive shafts	Check	Every 10,000 km (6,000 miles) or 6 months	MA-20, 23 FA-5, RA-5, 7
A . . . . . C . . . . . G H I . . . . .	Brake pads, discs & other brake components	Check	Every 5,000 km (3,000 miles) or 3 months	MA-22
. . . . . G . . . . .	Lock, hinges & hood latch	Lubricate		MA-24

Maintenance operation: Check = Check. Correct or replace if necessary.

## PERIODIC MAINTENANCE (For Europe)

The following tables show the normal maintenance schedule. Depending upon weather and atmospheric conditions, varying road surfaces, individual driving habits and vehicle usage, additional or more frequent maintenance may be required.

Periodic maintenance beyond the last period shown on the tables requires similar maintenance.

### ENGINE OIL SERVICE

Abbreviations: R = Replace.

MAINTENANCE OPERATION	MAINTENANCE INTERVAL										Reference page	
	km x 1,000	10	20	30	40	50	60	70	80	90		
Perform on kilometer basis or on month basis if not driven 10,000 km (6,000 miles) within a year.	(Miles x 1,000)	(6)	(12)	(18)	(24)	(30)	(36)	(42)	(48)	(54)	(60)	
	Months	12	24	36	48	60	72	84	96			

[Engine oil service]	Engine compartment and under vehicle										
Engine oil (Use API SG or SH oil only)*	R	R	R	R	R	R	R	R	R	R	MA-15
Engine oil filter (Use Part No. 15208-65F00)*	R	R	R	R	R	R	R	R	R	R	MA-16

NOTE: (1) Maintenance items with "\*" should be performed more frequently according to "Maintenance under severe driving conditions".

### MAJOR SERVICE (Engine)

Abbreviations: R = Replace. I = Inspect. Correct or replace if necessary. [ ]: At the specified mileage only

MAINTENANCE OPERATION	MAINTENANCE INTERVAL						Reference page
	Months	12	24	36	48	60	
Perform on month basis or on kilometer basis if driven 30,000 km (18,000 miles) within a year.	km x 1,000	30	60	90	120		
	(Miles x 1,000)	(18)	(36)	(54)	(72)		

Underhood and under vehicle						
Drive belts	See NOTE (1).	I	I	I	I	MA-12
Engine anti-freeze coolant (Ethylene glycol base)	See NOTE (2).					MA-12
Cooling system		I	I	I	I	MA-13
Fuel lines				I	I	MA-14
Air cleaner filter (Viscous paper type)*				R	R	MA-15
Fuel filter*					R	MA-15
Spark plug (Use PLATINUM-TIPPED type)					[R]	MA-16
Heated oxygen sensor (Except for Sweden)				I	I	MA-18
Vapor lines	See NOTE (3).			I	I	MA-17

- NOTE: (1) After 24 months or 60,000 km (36,000 miles), check every 12 months or 30,000 km (18,000 miles).  
 (2) Change at 60 months or 90,000 km (54,000 miles), then every 24 months or 60,000 km (36,000 miles).  
 (3) For Sweden perform at the first 90,000 km (54,000 miles), and then every 60,000 km (36,000 miles) or 24 months, whichever comes first.  
 (4) Maintenance items with "\*" should be performed more frequently according to "Maintenance under severe driving conditions".



## PERIODIC MAINTENANCE (For Europe)

### MAJOR SERVICE (Chassis and Body)

Abbreviations: R = Replace. I = Inspect. Correct or replace if necessary.

MAINTENANCE OPERATION	MAINTENANCE INTERVAL				Reference page	
	Months	12	24	36		48
	km x 1,000 (Miles x 1,000)	30 (18)	60 (36)	90 (54)		120 (72)
<b>Underhood and under vehicle</b>						
Brake & clutch oil level & leak★		I	I	I	I	MA-19, 21
Automatic transmission fluid (level & leakage)★		I	I	I	I	MA-20
Brake fluid★			R		R	MA-22
Brake booster vacuum hoses, connections & check valve			I		I	MA-22
Power steering fluid & lines		I	I	I	I	MA-23
Brake & clutch system		I	I	I	I	MA-19, 21
Manual transmission & standard differential gear oil (For leakage)★		I	I	I	I	MA-19, 21
Steering gear & linkage, axle & suspension parts, propeller shaft & drive shaft, exhaust system★			I		I	MA-20, 23 RA-5, 7, FA-5
<b>Outside and inside</b>						
Wheel alignment (if necessary, rotate & balance wheels)		I	I	I	I	MA-21 FA-6
Brake pads, discs & other brake components★		I	I	I	I	MA-22
Headlamp aiming		I	I	I	I	EL-64
Seat belts, buckles, retractors & adjuster		I	I	I	I	MA-24
Foot brake, parking brake & clutch (For free play, stroke & operation)		I	I	I	I	CL-4 BR-7, 23
Body corrosion		Annually				
Air bag system		See NOTE (1).				RS-5

NOTE: (1) Inspect at the first 10 years and then every 2 years.

(2) Maintenance items with "★" should be performed more frequently according to "Maintenance under severe driving conditions".

## PERIODIC MAINTENANCE (For Europe)

### MAINTENANCE UNDER SEVERE DRIVING CONDITIONS

The maintenance intervals shown on the preceding pages are for normal operating conditions. If the vehicle is mainly operated under severe driving conditions as shown below, more frequent maintenance must be performed on the following items as shown in the table.

#### Severe driving conditions

- |   |   |
|---|---|
| <p>A — Driving under dusty conditions<br/>                 B — Driving repeatedly short distances<br/>                 C — Towing a trailer<br/>                 D — Extensive idling<br/>                 E — Driving in extremely adverse weather conditions or in areas where ambient temperature are either extremely low or extremely high</p> | <p>F — Driving in high humidity areas or in mountainous areas<br/>                 G — Driving in areas using salt or other corrosive materials<br/>                 H — Driving on rough and/or muddy roads or in the desert<br/>                 I — Driving with frequent use of braking or in mountainous areas</p> |
|---|---|

Driving condition		Maintenance item	Maintenance operation	Maintenance interval	Reference page
<b>Engine oil service</b>					
A	B C D	Engine oil	Replace	Every 5,000 km (3,000 miles) or 6 months	MA-15
A	B C D	Engine oil filter	Replace	Every oil change	MA-16
<b>Major service</b>					
A		Air cleaner filter	Replace		MA-15
A	E	Fuel filter	Replace		MA-16
	F	Brake fluid	Replace	Every 12 months or 30,000 km (18,000 miles)	MA-21
	G H	Steering gear & linkage, axle & suspension parts, propeller shaft & drive shaft, exhaust system	Check		MA-20, 23 FA-5, RA-5, 7
	C	Automatic & manual transmission & differential gear oil	Replace	Every 24 months or 60,000 km (36,000 miles)	MA-19, 20, 21
A	C G H I	Brake pads, discs & other brake components	Check	Every 6 months or 15,000 km (9,000 miles)	MA-22

## RECOMMENDED FLUIDS AND LUBRICANTS

### Fluids and Lubricants

	Capacity (Approximate)		Recommended fluids and lubricants
	Liter	Imp measure	
Engine oil (Refill)			
With oil filter	3.7	3-1/4 qt	API SF/CC, SF/CD, SE, SG or SH*1
Without oil filter	3.5	3-1/8 qt	
Cooling system (with reservoir tank)	6.2	5-1/2 qt	Anti-freeze coolant (Ethylene glycol base) or soft water
Manual transmission oil	2.4	4-1/4 pt	API GL-4*
Differential carrier gear oil	1.8	3-1/8 pt	API GL-5*
Automatic transmission fluid	7.9	7 qt	Genuine Nissan ATF or equivalent*2
Power steering fluid	0.9	3/4 qt	Type DEXRON™
Brake and clutch fluid	—	—	For Europe DOT3 or DOT4 (US FMVSS No. 116)*3 Except for Europe DOT3 (US FMVSS No. 116)
Multi-purpose grease	—	—	NLGI No. 2 (Lithium soap base)

\*1: For further details, see "SAE Viscosity Number".

\*2: For more information regarding suitable fluids, contact a Nissan dealership.

\*3: Never mix different type fluids. (DOT3 and DOT4)

## RECOMMENDED FLUIDS AND LUBRICANTS

### SAE Viscosity Number

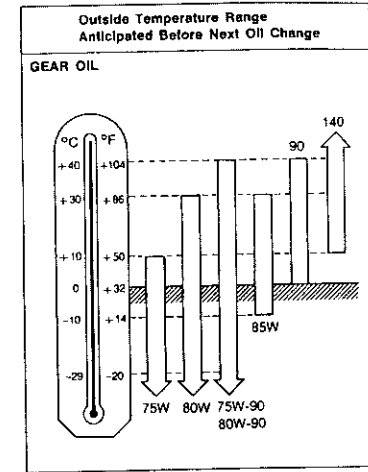
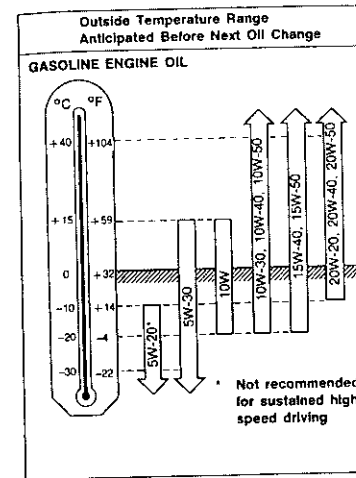

T10005

T10003

- 5W-30 or 10W-30 is preferable regardless of driving conditions.

- For warm and cold areas: 75W-90 for transmission and 80W-90 for differential carrier are preferable.
- For hot areas: 90 is suitable for ambient temperatures below 40°C (104°F).

## ENGINE MAINTENANCE

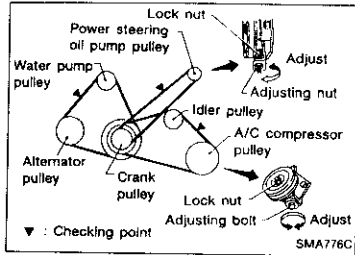

### Checking Drive Belts

1. Inspect for cracks, fraying, wear or oil adhesion. If necessary, replace with a new one.
2. Inspect drive belt deflections by pushing on the belt midway between pulleys.

Adjust if belt deflections exceed the limit.

#### Belt deflection:

Unit: mm (in)

	Used belt deflection		Deflection of new belt
	Limit	Deflection after adjustment	
Alternator	11 (0.43)	7 - 8 (0.28 - 0.31)	4 - 5 (0.16 - 0.20)
Air conditioner compressor	7 (0.28)	5 - 6 (0.20 - 0.24)	6 - 7 (0.24 - 0.28)
Power steering oil pump	15 (0.59)	11 - 12 (0.43 - 0.47)	9 - 10 (0.35 - 0.39)
Applied pushing force	98 N (10 kg, 22 lb)		

Inspect drive belt deflections when engine is cold.

### Changing Engine Coolant

#### WARNING:

To avoid being scalded, never change the coolant when the engine is hot.

On this model it is unnecessary to move heater "TEMP" control lever or switch before changing the coolant. This is because air mix door is in "HOT" position when ignition switch is "OFF". (This applies to both automatic and manual air conditioners.)

1. Remove radiator drain plug and radiator cap.
  2. Remove reservoir tank, drain coolant, then clean reservoir tank.  
Install it temporarily.
- Be careful not to allow coolant to contact drive belts.

3. Remove cylinder block drain plug, air relief plug and air bleeder cap.
4. Install radiator drain plug and tighten cylinder block drain plug securely.
5. Fill radiator and reservoir tank with water.  
Air relief plug is reinstalled once coolant spills from the air relief hole during refill.  
Then fill radiator and reservoir tank with water.  
**Air relief plug:**  
Ⓜ: 10 N·m (1.0 kg-m, 7 ft-lb)
6. Reinstall radiator cap and air bleeder cap.

MA-12

## ENGINE MAINTENANCE

### Changing Engine Coolant (Cont'd)

7. Warm up engine until cooling fan operates, then race engine 2 or 3 times under no-load.
- Make sure that air conditioner switch is "OFF".
8. Stop engine and wait until it cools down.
9. Repeat step 1 through step 8 until clear water begins to drain from radiator.
10. Drain water.
- Apply sealant to the thread of drain plug.  
Ⓜ: 8 - 12 N·m (0.8 - 1.2 kg-m, 5.8 - 8.7 ft-lb)
11. Reinstall reservoir tank.

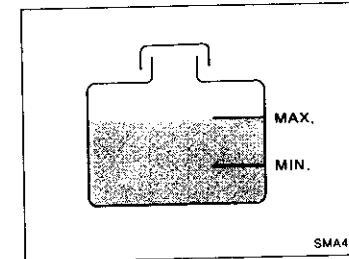
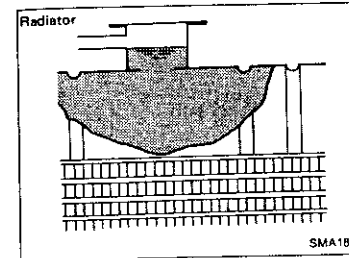
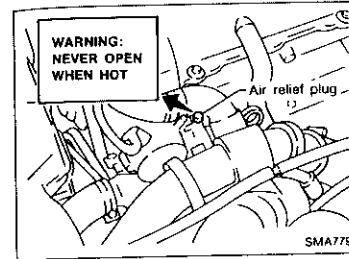

12. Fill radiator and reservoir tank with coolant up to specified level following step 5 through step 8.  
Follow instructions attached to anti-freeze container for mixing ratio of anti-freeze to water.  
**Coolant capacity (With reservoir tank):**  
6.2 l (5-1/2 Imp qt)

[Reservoir tank capacity for "H" level is 1.8 l (1-5/8 Imp qt).]  
Pour coolant through coolant filler neck slowly to allow air in system to escape.

13. If necessary, add coolant.
14. Start and warm up engine, then increase engine speed to 4,000 rpm. Check that radiator coolant level is not lowered, and that no water noise is heard in heater core. If water noise is heard, bleed air by referring to "Refilling Engine Coolant" in section LC.

### Checking Cooling System

#### CHECKING HOSES

Check hoses for improper attachment and for leaks, cracks, damage, loose connections, chafing and deterioration.

#### CHECKING RADIATOR CAP

Apply pressure to radiator cap with cap tester to see if it is satisfactory.

**Radiator cap relief pressure:**

78 - 98 kPa  
(0.78 - 0.98 bar, 0.8 - 1.0 kg/cm<sup>2</sup>, 11 - 14 psi)

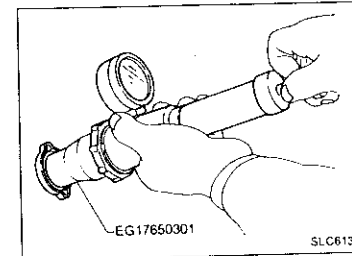

MA-13

## ENGINE MAINTENANCE

### Checking Cooling System (Cont'd)

Pull the negative-pressure valve to open it. Check that it closes completely when released.

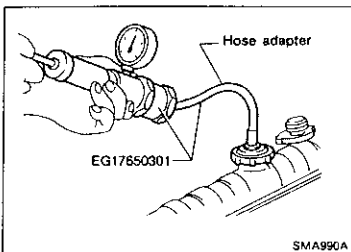
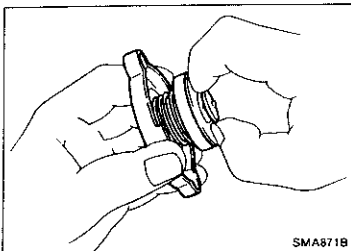

### CHECKING COOLING SYSTEM FOR LEAKS

Apply pressure to the cooling system with cap tester to check for leakage.

Testing pressure:  
157 kPa (1.57 bar, 1.6 kg/cm<sup>2</sup>, 23 psi)

**CAUTION:**  
Higher pressure than the specified value may cause damage to radiator.

### Checking Fuel Lines

Inspect fuel lines and tank for improper attachment and for leaks, cracks, damage, loose connections, chafing and deterioration.

If necessary, repair or replace faulty parts.

### CAUTION:

Tighten high-pressure rubber hose clamp so that clamp end is 3 mm (0.12 in) from hose end.

Tightening torque specifications are the same for all rubber hose clamps.

Ensure that screw does not contact adjacent parts.

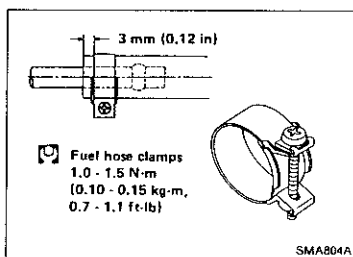

### Changing Fuel Filter

#### WARNING:

Before removing fuel filter, release fuel pressure from fuel line to eliminate danger.

## ENGINE MAINTENANCE

### Changing Fuel Filter (Cont'd)

1. Remove fuse for fuel pump.
2. Start engine.
3. After engine stalls, crank engine two or three times to make sure that fuel pressure is released.
4. Turn ignition switch off and install fuse for fuel pump.

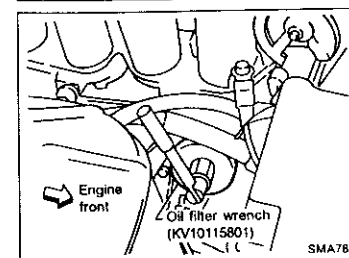
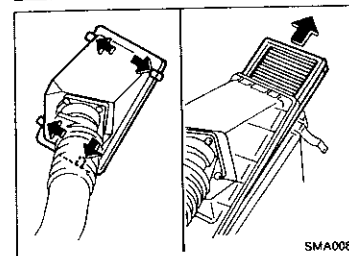
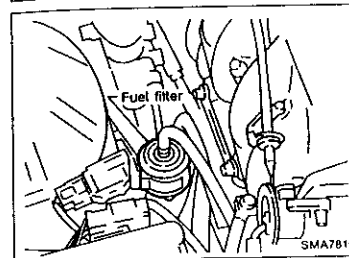
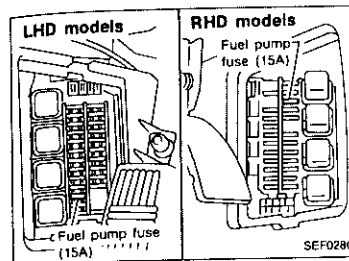

5. Loosen fuel hose clamps.
  6. Replace fuel filter.
- Be careful not to spill fuel over engine compartment. Place a shop towel to absorb fuel.
  - Use a high-pressure type fuel filter. Do not use a synthetic resinous fuel filter.
  - When tightening fuel hose clamps, refer to "Checking Fuel Lines".

### Changing Air Cleaner Filter

#### Viscous paper type

The viscous paper type filter does not need cleaning between renewals.

### Changing Engine Oil

#### WARNING:

- Be careful not to burn yourself, as the engine oil is hot.
- Prolonged and repeated contact with used engine oil may cause skin cancer; try to avoid direct skin contact with used oil. If skin contact is made, wash thoroughly with soap or hand cleaner as soon as possible.

1. Warm up engine, and check for oil leakage from engine components.

2. Remove drain plug and oil filler cap.
3. Drain oil and refill with new engine oil.

#### Refill oil capacity (Approximate):

With oil filter change

3.7 ℓ (3-1/4 Imp qt)

Without oil filter change

3.5 ℓ (3-1/8 Imp qt)

#### CAUTION:

- Be sure to clean drain plug and install with new washer.  
Drain plug:  
[ ]: 29 - 39 N·m (3.0 - 4.0 kg·m, 22 - 29 ft·lb)
- Use recommended engine oil.