



**REPAIR MANUAL
FOR CNH U.K.
ENGINES**

**F4BE0454B
F4BE0484D
F4BE0484E
F4BE0684B
F4BE0684M**

REPAIR MANUAL FOR CNH U.K. ENGINES

**F4BE0454B
F4BE0484D · E F4BE0684B · M**

This is the cut pages sample. Download all 209 page(s) at: ManualPlace.com

**New Holland Engines F4be0454b F4be0484d F4be0484e F4be0684b Repair Manual
Full download: <http://manualplace.com/download/new-holland-engines-f4be0454b-f4be0484d-f4be0484e-f4be0684b-repair-m>**

Print No. 604.13.582
English - Printed in Italy



REPAIR MANUAL FOR CNH U.K. ENGINES

F4BE0454B – F4BE0484D – F4BE0484E

F4BE0684B – F4BE0684M

The following models are to integrate repair manuals:

NEW HOLLAND KOBELCO E145 – E175 – E195 – E215 – E245

NEW HOLLAND MH2.6 – MH3.6 – MH4.6 – MH Plus C

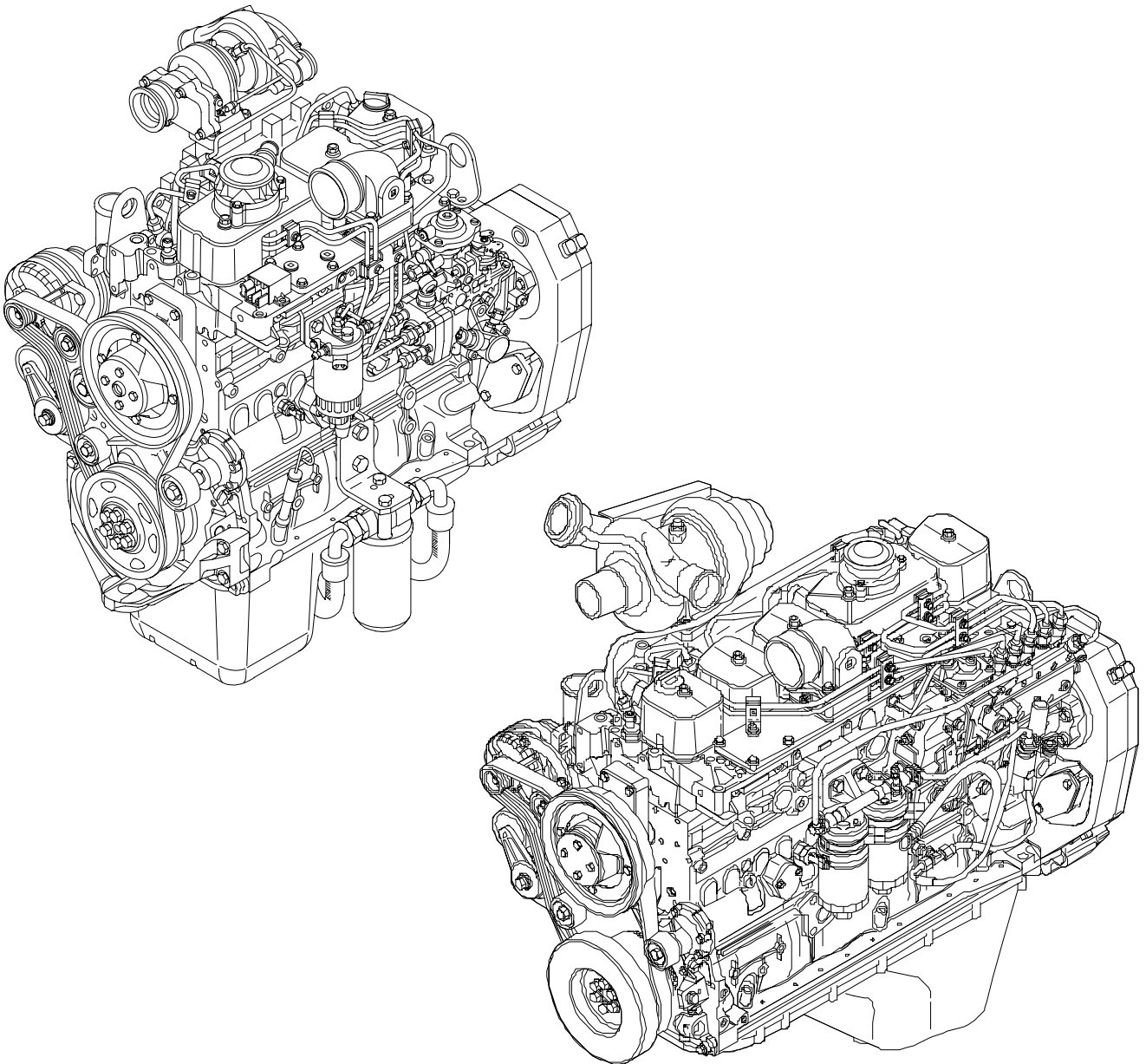

Every information, illustration and specification contained in the present manual is based on the most recent information available at the time of printing.

NEW HOLLAND reserves the right, to modify the text at any time without prior communication.

INTRODUCTION

TO THE READER

- This manual was written for a skilled technician and contains all the technical information needed to repair this vehicle.
- Read this manual carefully for the information concerning repairing operations.
- For any question or comment, or should you notice any mistake concerning the content of this manual, please contact:

NEW HOLLAND
 Strada Settimo, 323
 San Mauro Torinese (TO)
 10099 ITALIA
 PRODUCT SUPPORT
 Fax ++39 011 0077357

FURTHER REFERENCES**PAGE NUMBER**

- Every page carries a number on the top right corner. Every page contains the following information:

Example: **T 1 - 2 - 3**

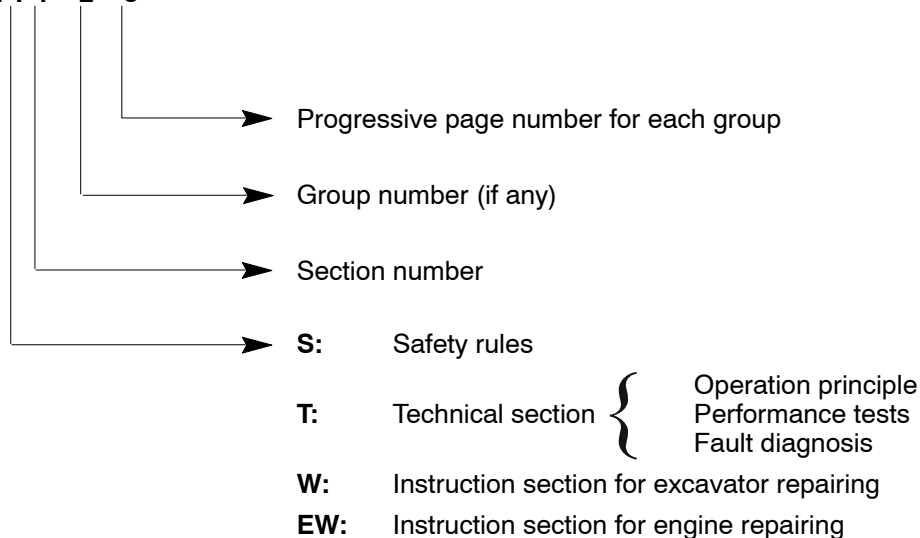

SYMBOLS

This manual contains safety warning symbols and indications referring to possible injuries or vehicle damages.



This symbol regards safety.

Use great care when you see this symbol because possible injuries to the personnel may occur.

Strictly observe the precautions marked with this symbol.

The safety warning symbol is used also to draw attention on the weight of a component or an element.

Make sure you are always using the right equipment and lifting techniques when handling heavy loads, in order to prevent injuries or damages.

UNIT OF MEASURE

This manual adopts the units of measure based on the International System.

The MKSA system units of measure are indicated within brackets after the units of measure of the International System.

Example: 24.5 Mpa (250 kgf/cm²).

The following table converts the International System units of measure in some of the main units belonging to other systems.

Quantity	To convert from (IS)	in (Others)	Multiply by	Quantity	To convert from (IS)	in (Others)	Multiply by
Length	mm	in	0.03937	Pressure	MPa	kgf/cm ²	10.197
	mm	ft	0.003281		MPa	psi	145.0
Volume	L	US gal	0.2642	Power	kW	PS	1.360
	L	US qt	1.057		kW	HP	1.341
	m ³	yd ³	1.308	Temperature	°C	°F	°C x 1.8 + 32
Mass	kg	lb	2.205	Speed	km/h	mph	0.6214
Force	N	kgf	0.10197		min ⁻¹	rpm	1.0
	N	lbf	0.2248	Capacity	L/min	US gpm	0.2642
Torque	N.m	kgf.m	0.10197		mL/rev	cc/rev	1.0
	N.m	lbf.ft	0.7375				

ENGINES

INDEX OF SECTIONS



Section 1 – Diagnostics

EW-1-1



Section 2 – Engines overhaul:

- F4BE0454B
- F4BE0484D
- F4BE0484E

EW-2-1



Section 3 – Engine overhaul:

- F4BE0684B
- F4BE0684M

EW-3-1

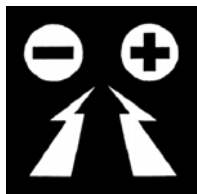

Section 4 – Recharging and start-up

EW-4-1

DIAGNOSTICS



INDEX

Diagnostics	EW-1-3
--------------------------	--------

DIAGNOSTICS

Main engine operating anomalies:

- | | |
|--|--|
| <ul style="list-style-type: none"> 1 – Engine won't start; 2 – Engine overheats; 3 – Engine lacks power and works erratically; 4 – Engine exhaust smoke black or dark grey; 5 – Engine exhaust smoke grey (verging on white); | <ul style="list-style-type: none"> 6 – Engine exhaust smoke light blue; 7 – Engine knocks irregularly; 8 – Engine stops; 9 – Engine exceeds max. revs number; 10 – Excessive or insufficient oil pressure; 11 – Excessive fuel consumption; 12 – Engine won't stop. |
|--|--|

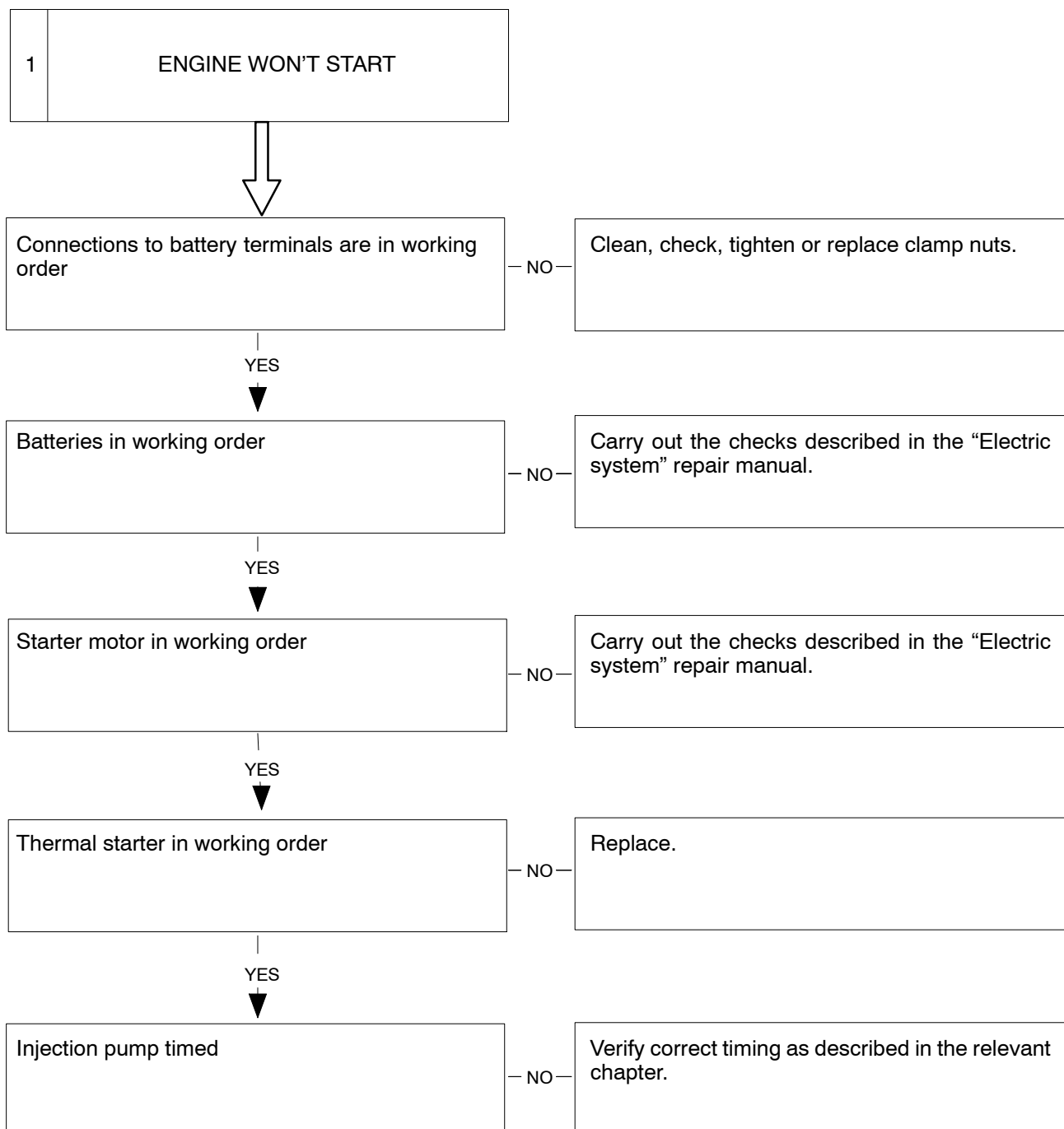

(to be continued)

DIAGNOSTICS

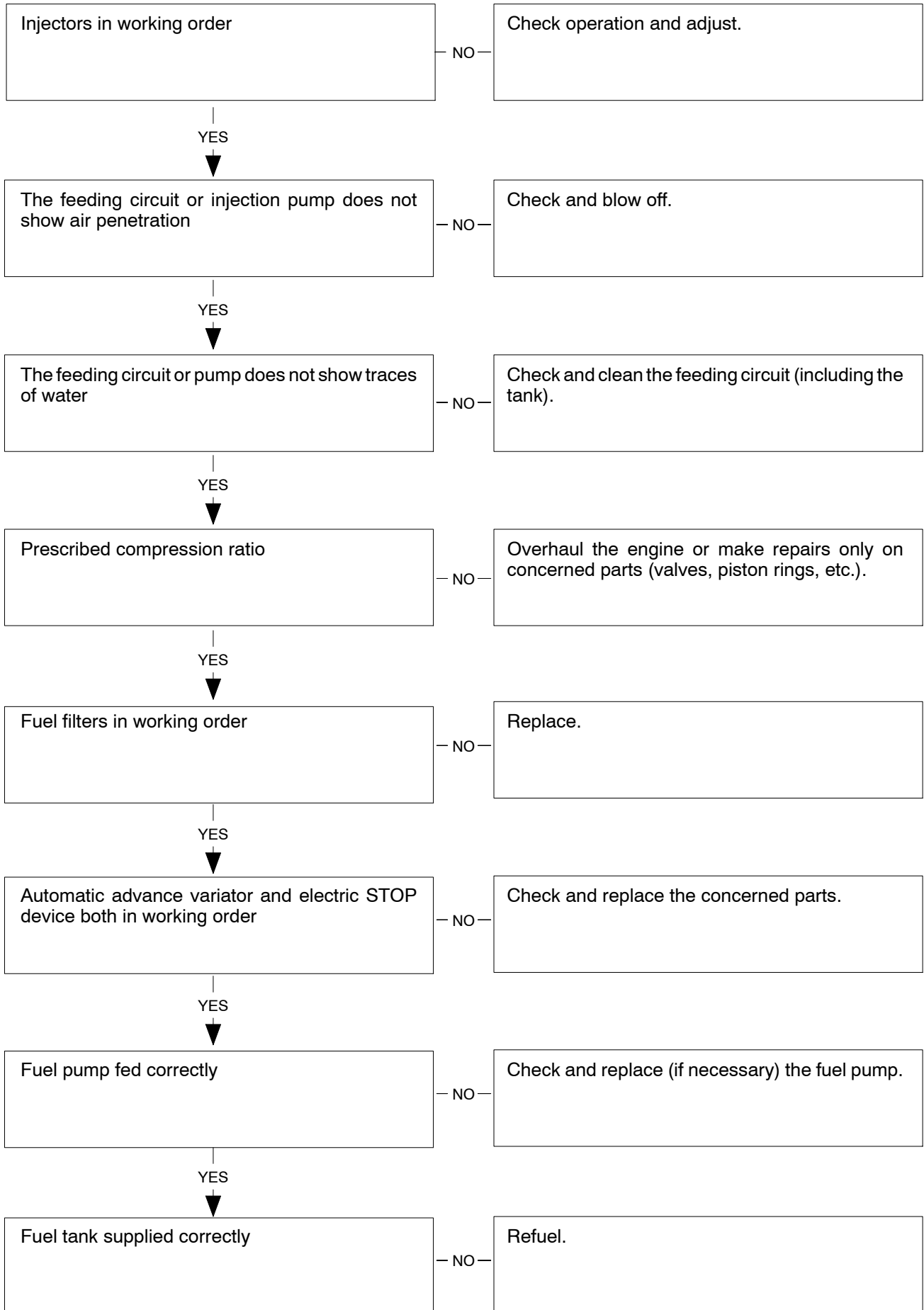

DIAGNOSTICS

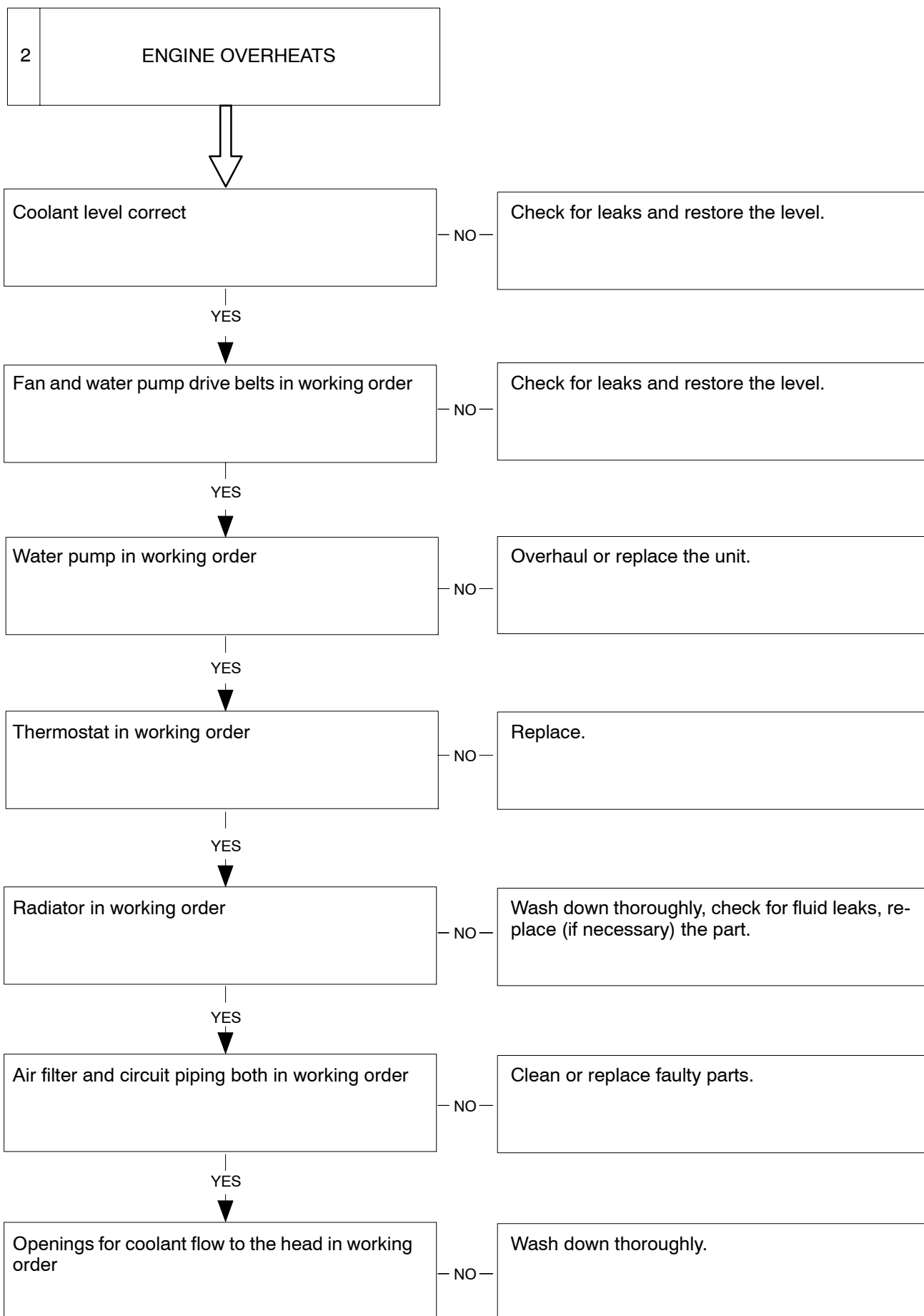

DIAGNOSTICS

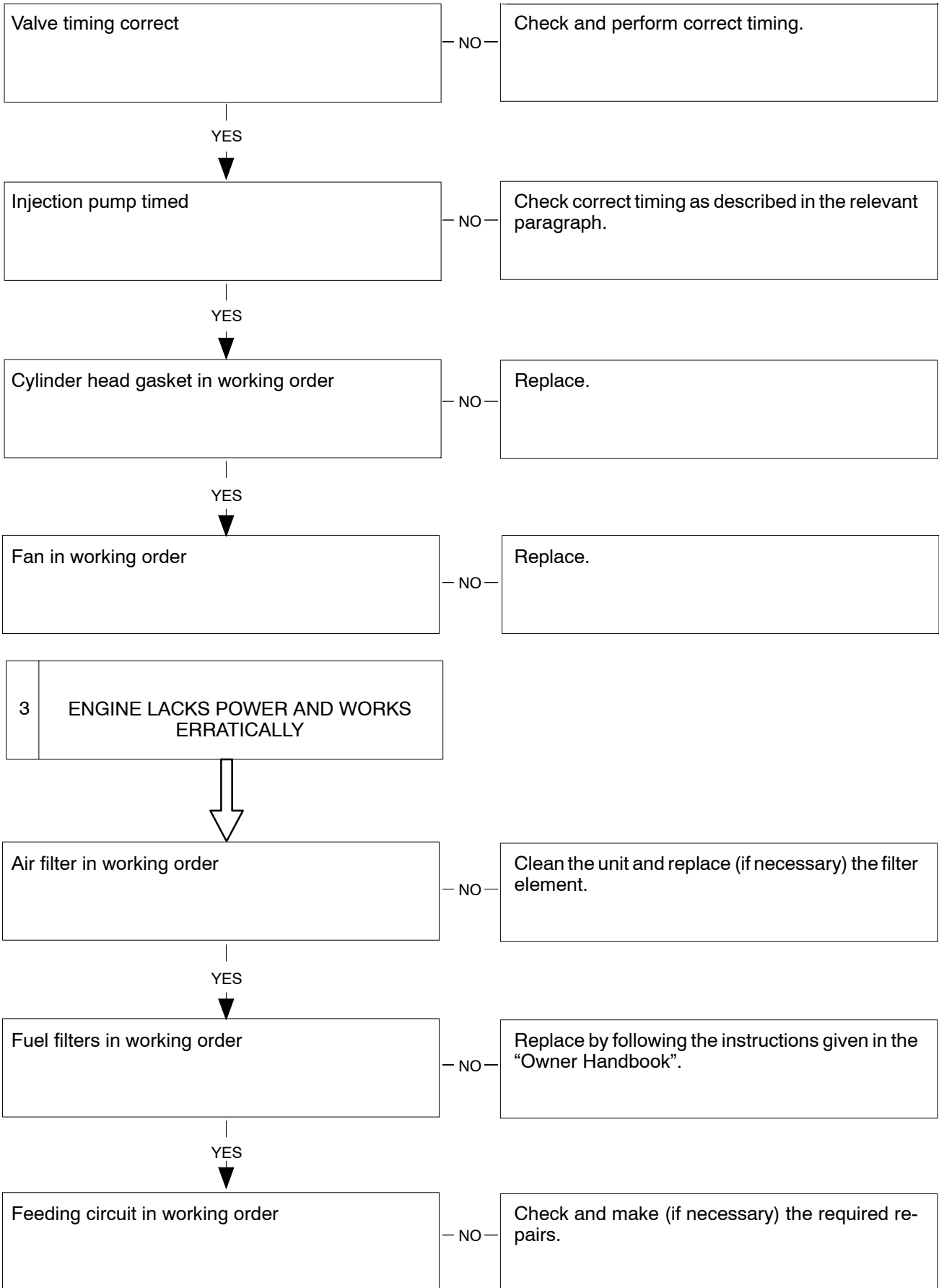

(to be continued)

DIAGNOSTICS

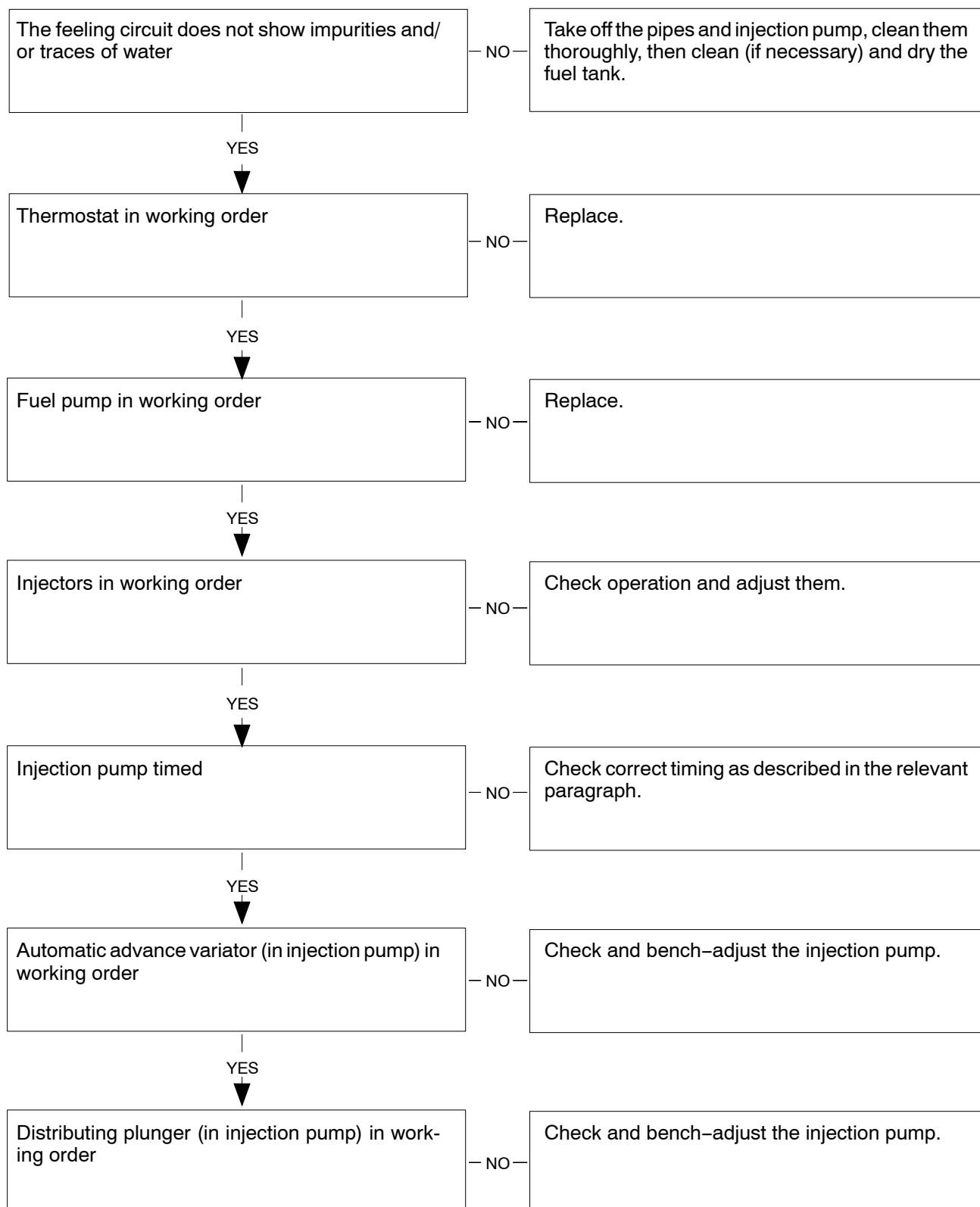

(to be continued)

DIAGNOSTICS

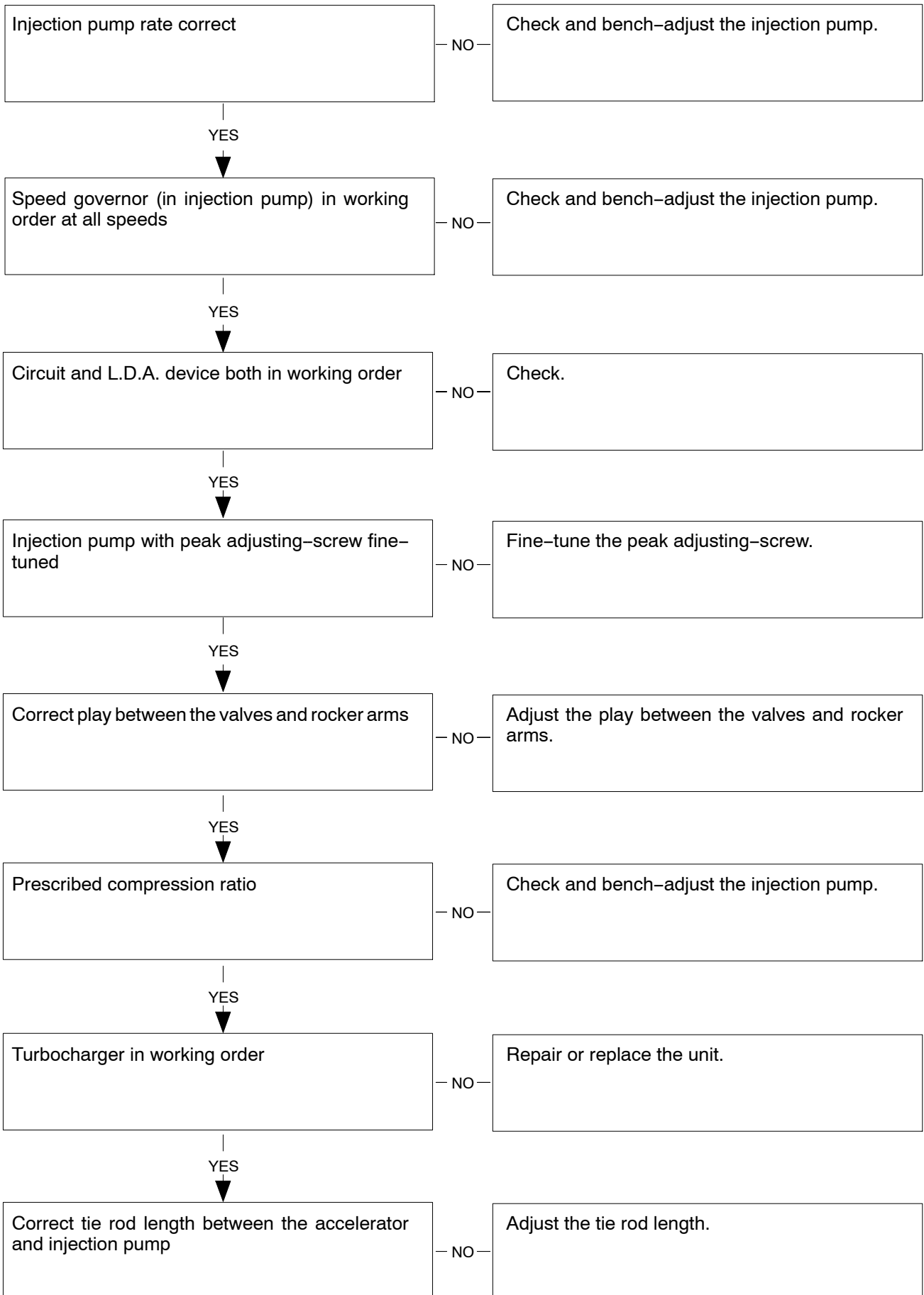

DIAGNOSTICS

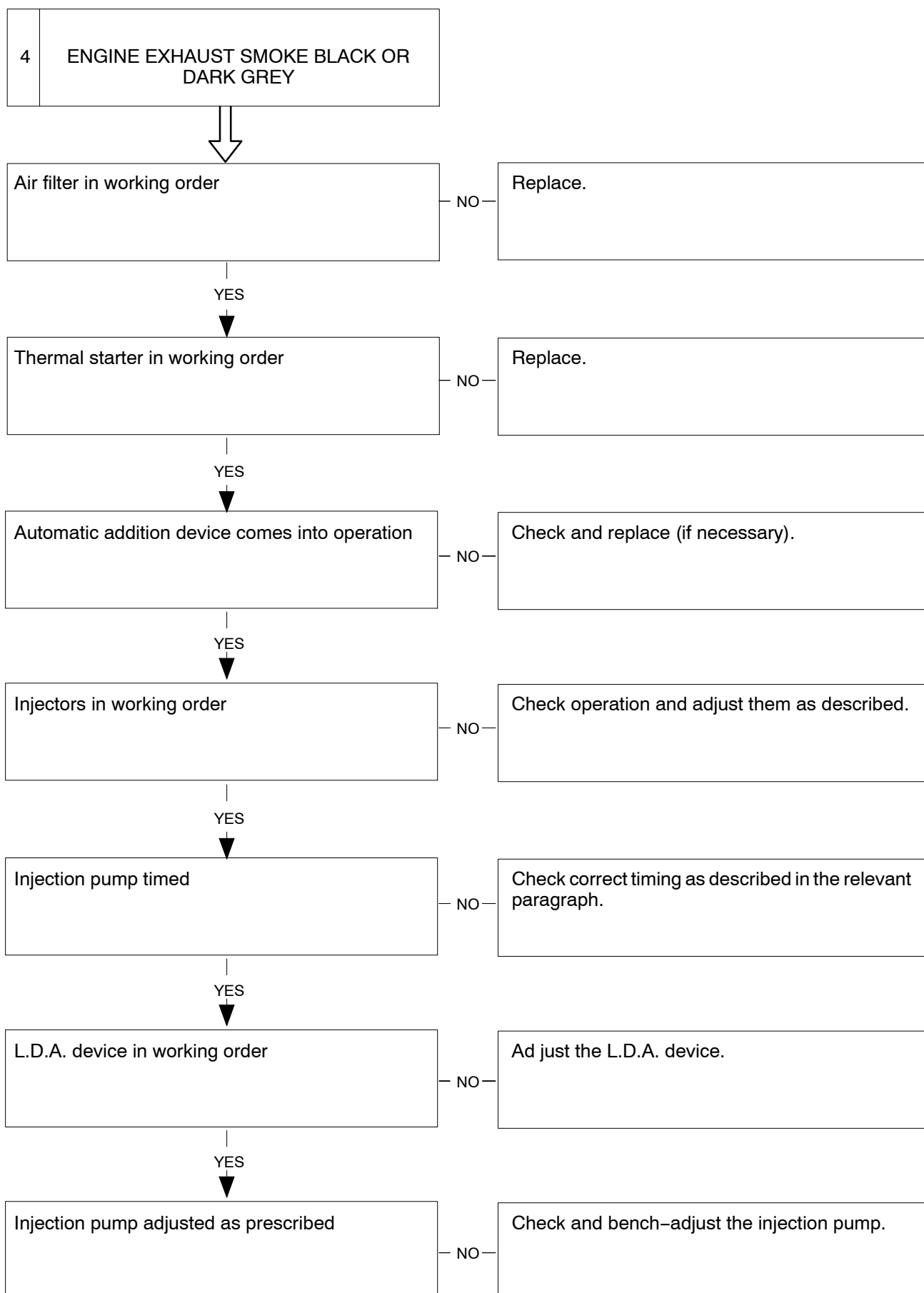

(to be continued)

DIAGNOSTICS

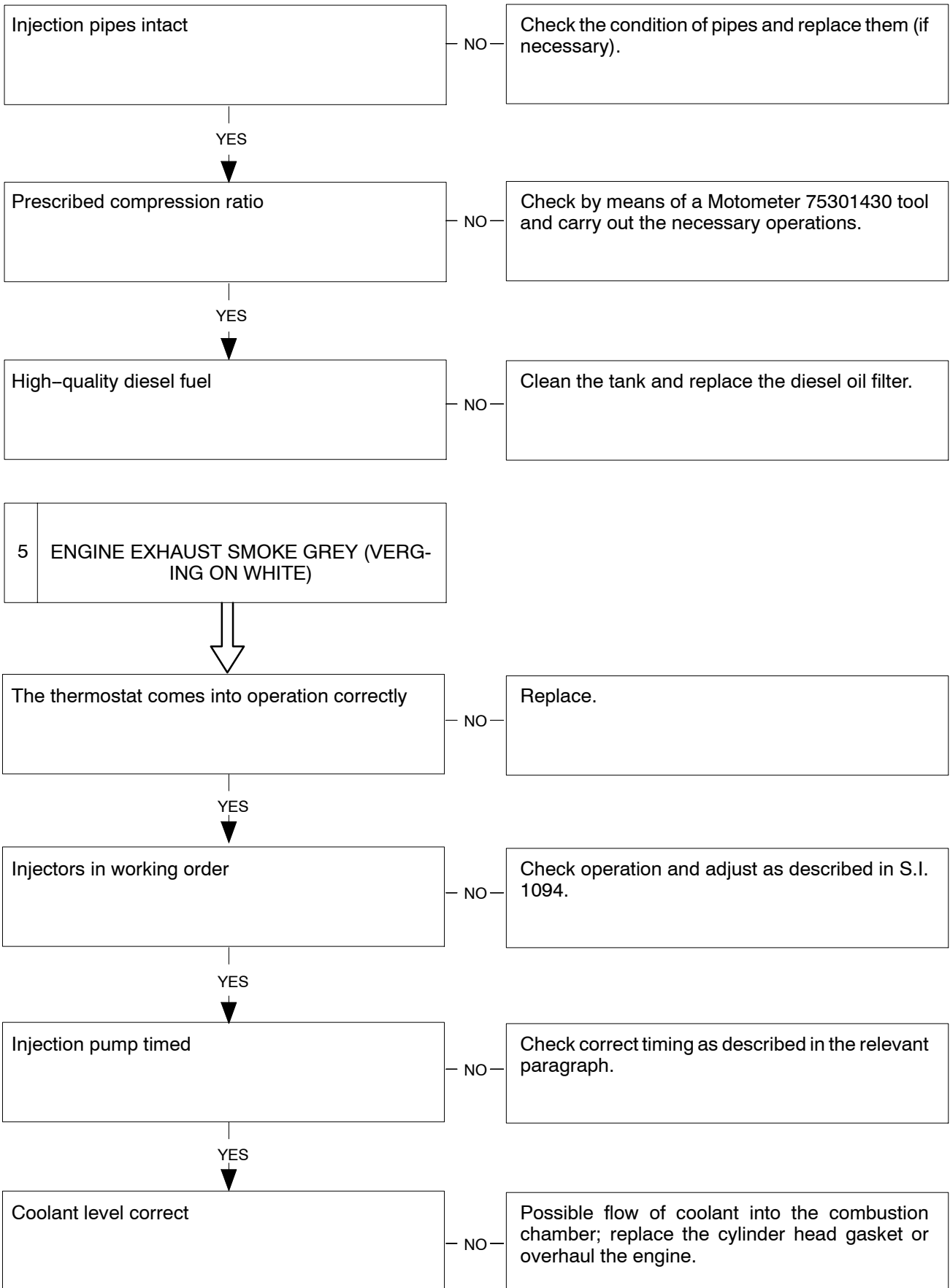

(to be continued)

DIAGNOSTICS

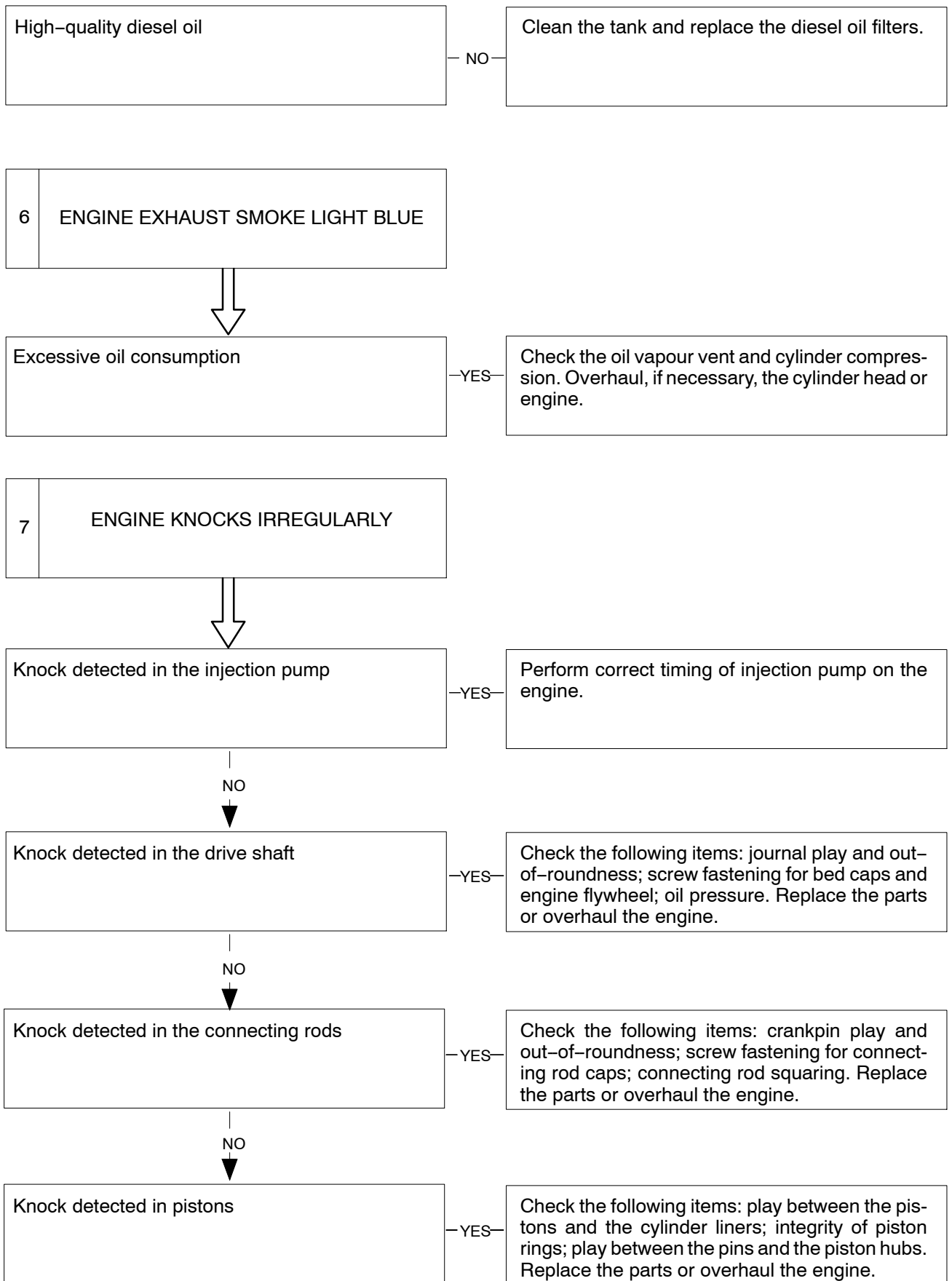

(to be continued)

DIAGNOSTICS

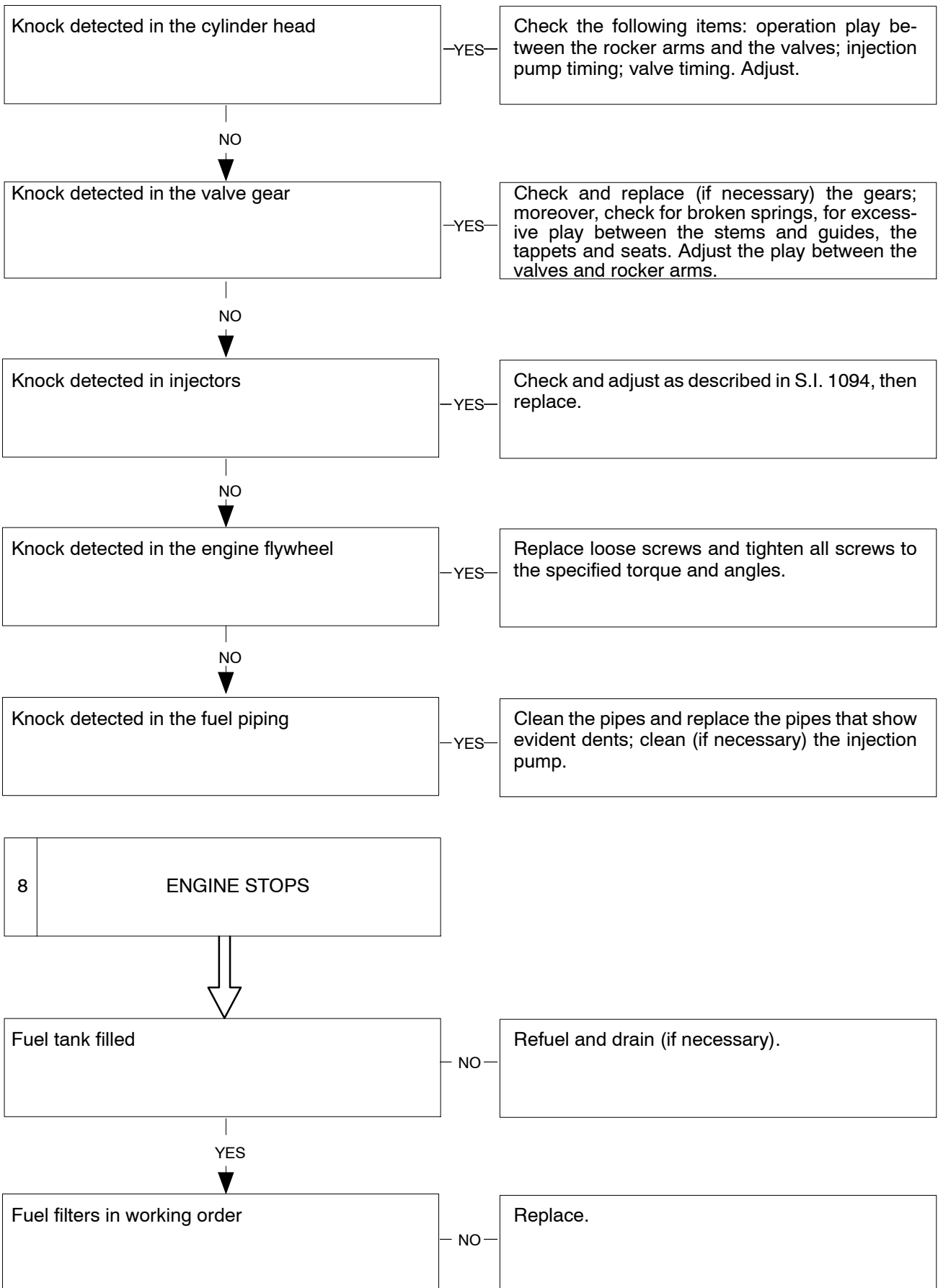

(to be continued)

DIAGNOSTICS

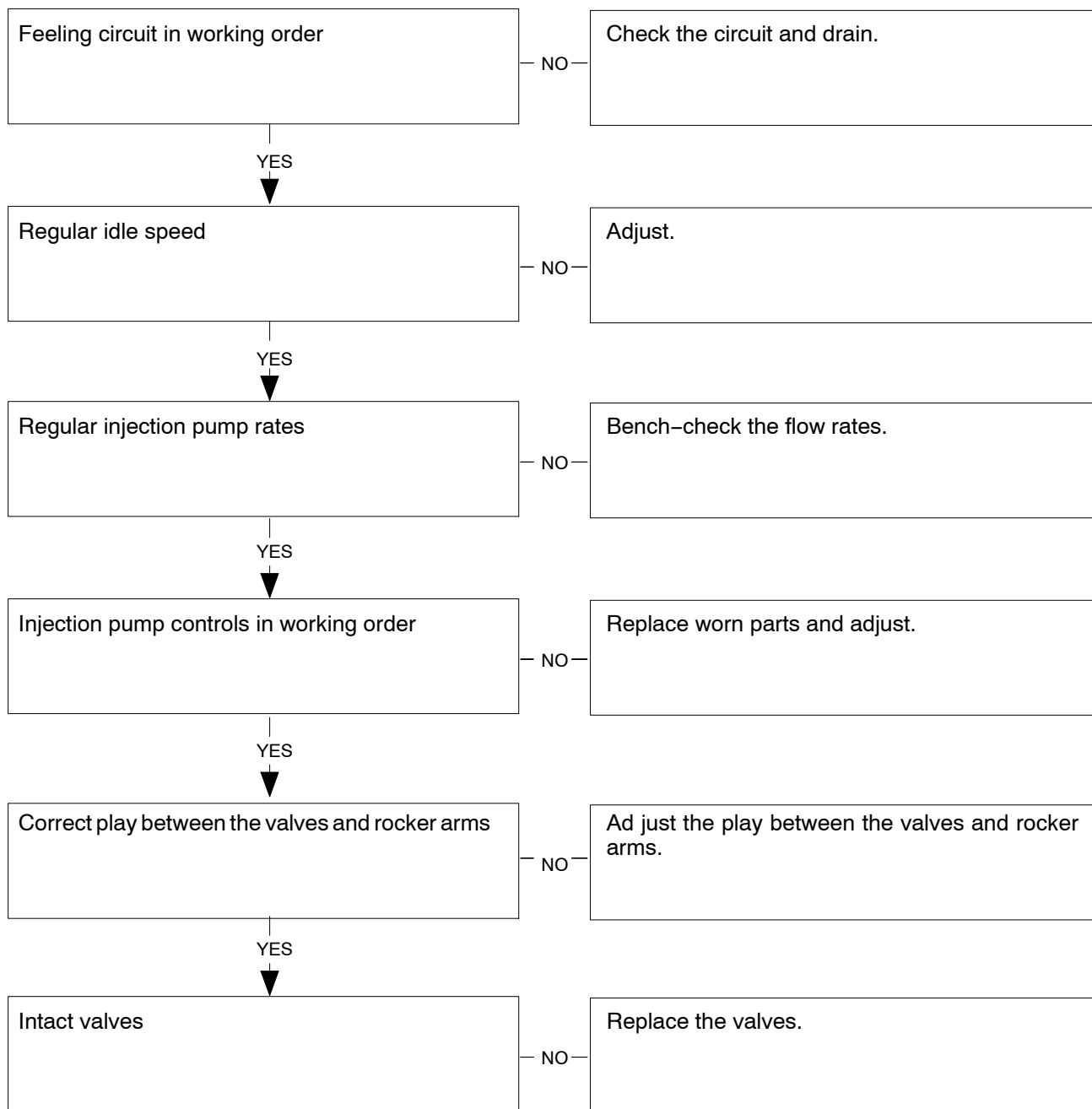

9 ENGINE EXCEEDS MAX. REVS NUMBER

