

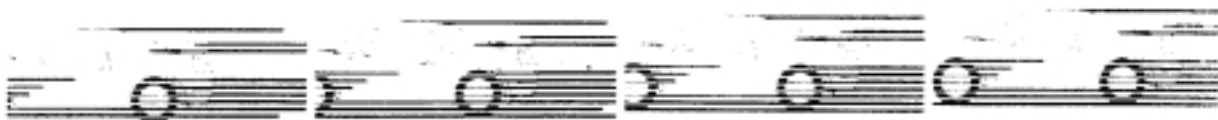

# Workshop Manual

## chassis

### FTO '98

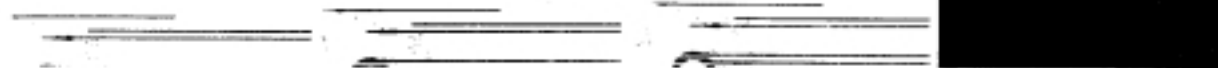
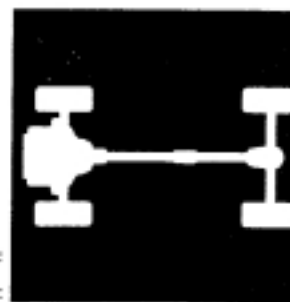

# FTO

## WORKSHOP MANUAL

### FOREWORD

This Workshop Manual contains procedures for service mechanics, including removal, disassembly, inspection, adjustment, reassembly and installation. Use the following manuals in combination with this manual as required.

TECHNICAL INFORMATION MANUAL	PYME9801
WORKSHOP MANUAL	
ENGINE GROUP	PWEE9801
ELECTRICAL WIRING	PHME9801
BODY REPAIR MANUAL	PBME9801
PARTS CATALOGUE	B806G208A□

All information, illustrations and product descriptions contained in this manual are current as at the time of publication. We, however, reserve the right to make changes at any time without prior notice or obligation.



General .....	00
Engine .....	11
Engine Lubrication .....	12
Fuel .....	13
Engine Cooling .....	14
Intake and Exhaust .....	15
Engine Electrical .....	16
Emission Control .....	17
Clutch .....	21
Manual Transmission .....	22
Automatic Transmission .....	23
Front Axle .....	26
Rear Axle .....	27
Wheel and Tyre .....	31
Power Plant Mount .....	32
Front Suspension .....	33
Rear Suspension .....	34
Service Brakes .....	35
Parking Brakes .....	36
Steering .....	37
Body .....	42
Exterior .....	51
Interior and Supplemental Restraint System (SRS) .....	52
Chassis Electrical .....	54
Heater, Air Conditioner and Ventilation .....	55

## **WARNINGS REGARDING SERVICING OF SUPPLEMENTAL RESTRAINT SYSTEM (SRS) EQUIPPED VEHICLE**

### **WARNING!**

- (1) Improper service or maintenance of any component of the SRS or any SRS-related component, can lead to personal injury or death to service personnel (from inadvertent firing of the air bag) or to the driver and passenger (from rendering the SRS inoperative).
- (2) SRS components should not be subjected to heat over 93°C, so remove the SRS-ECU, air bag module (driver's side and front passenger's side) and clock spring before drying or baking the vehicle after painting.
- (3) Service or maintenance of any SRS component or SRS-related component must be performed only at an authorized MITSUBISHI dealer.
- (4) MITSUBISHI dealer personnel must thoroughly review this manual, and especially its GROUP 52B – Supplemental Restraint System (SRS), before beginning any service or maintenance of any component of the SRS or any SRS-related component.

### **NOTE**

Section titles with asterisks (\*) in the table of contents in each group indicate operations requiring warnings.

# GENERAL

## CONTENTS

<b>HOW TO USE THIS MANUAL</b> .....	<b>2</b>	Models .....	13
Scope of Maintenance, Repair and Servicing		Model Code .....	14
Explanations .....	2	Chassis Number .....	15
Indication of Destination .....	2	Engine Model Number .....	15
Definition of Terms .....	2	<b>MAJOR SPECIFICATIONS</b> .....	<b>16</b>
Indication of Tightening Torque .....	2	<b>PRECAUTIONS BEFORE SERVICE</b> .....	<b>17</b>
Model Indications .....	3	<b>SUPPLEMENTAL RESTRAINT SYSTEM (SRS)</b>	
Explanation of Manual Contents .....	4	.....	21
<b>HOW TO USE</b>			





## EXPLANATION OF MANUAL CONTENTS

Indicates procedures to be performed before the work in that section is started, and procedures to be performed after the work in that section is finished.

**Component Diagram**

A diagram of the component parts is provided near the front of each section in order to give a reader a better understanding of the installed condition of component parts.

Indicates (by symbols) where lubrication is necessary.

**Maintenance and Servicing Procedures**

The numbers provided within the diagram indicate the sequence for maintenance and servicing procedures.

- **Removal steps:**  
The part designation number corresponds to the number in the illustration to indicate removal steps.
- **Disassembly steps:**  
The part designation number corresponds to the number in the illustration to indicate disassembly steps.

- **Installation steps:**  
Specified in case installation is impossible in reverse order of removal steps. Omitted if installation is possible in reverse order of removal steps.
- **Reassembly steps:**  
Specified in case reassembly is impossible in reverse order of disassembly steps. Omitted if reassembly is possible in reverse order of disassembly steps.





**Classifications of Major Maintenance/Service Points**

When there are major points relative to maintenance and servicing procedures (such as essential maintenance and service points, maintenance and service standard values, information regarding the use of special tools, etc.), these are arranged together as major maintenance and service points and explained in detail.

- ◀A▶ : Indicates that there are essential points for removal or disassembly.  
▶A◀ : Indicates that there are essential points for installation or reassembly.

**Symbols for Lubrication, Sealants and Adhesives**

Information concerning the locations for lubrication and for application of sealants and adhesives is provided, by using symbols, in the diagram of component parts or on the page following the component parts page, and explained.

-  : Grease  
(multipurpose grease unless there is a brand or type specified)
-  : Sealant or adhesive
-  : Brake fluid or automatic transmission fluid
-  : Engine oil, gear oil or air conditioner compressor oil
-  : Adhesive tape or butyl rubber tape

Indicates the group title.

Indicates the section title.

Indicates the group number.

Indicates the page number.

**STEERING – Power Steering Oil Pump** 37A-29

---

**POWER STEERING GEAR BOX  
REMOVAL AND INSTALLATION**

**Prerequisites:** Operation  
 (1) Power Steering Fluid Draining (Refer to P-37A-10)  
 (2) Air Cleaner Assembly Removal  
 (3) Under-Cover Removal (Refer to DFCJ-P-42, Under-Cover)

**Oil pump seal kit**      **Oil pump cartridge kit**

**Removal steps:**  
 1. Lower shaft assembly and gear box connecting bolt  
 2. Split pin  
 3. Connection for tie rod end and knuckle  
 4. Connection for return tube  
 5. Connection for pressure tube  
 6. Clamp  
 7. Gear box assembly

**REMOVAL SERVICE POINTS**  
**4A TI-ROD END DISCONNECTION**

**Caution:**  
 1. Using the special tool, loosen the tie rod end mounting nut. Only loosen the nut; do not remove it from the ball joint.  
 2. Support the special tool with a cord, etc. to prevent it from coming off.

**HEADLAMP RELAY CONTINUITY INSPECTION**

Battery voltage	Terminal No.			
	1	3	4	5
Power is not supplied	○	○	○	○
Power is supplied	⊕	⊕	⊕	⊕

**35A-26 BASIC BRAKE SYSTEM – Master Cylinder and Brake Booster**

**Lubrication and sealing points**

**Sealer:** 3M ATD Part No. 3663 or equivalent

**N** denotes non-reusable part.

Denotes tightening torque. For bolts and nuts which do not have a tightening torque listed, refer to the "Standard Parts-tightening-torque Table".

Repair kit or set parts are shown. (Only very frequently used parts are shown.)

Operating procedures, cautions, etc. on removal, installation, disassembly and reassembly are described.

○—○ indicates that there is a continuity between the terminals.  
 ⊕—⊕ indicates terminals to which battery voltage is applied.

The title of the page (following the page on which the diagram of component parts is presented) indicating the locations of lubrication and sealing procedures.



## HOW TO USE TROUBLESHOOTING/INSPECTION SERVICE POINTS

Troubleshooting of electronic control systems for which the MUT-II can be used follows the basic outline described below. Furthermore, even in systems for which the MUT-II cannot be used, part of these systems still follow this outline.

### TROUBLESHOOTING CONTENTS

#### 1. STANDARD FLOW OF DIAGNOSIS TROUBLESHOOTING

The troubleshooting sections follow the basic diagnosis flow which is given below. If the diagnosis flow is different from that given below, or if additional explanation is required, the details of such differences or additions will also be listed.

#### Diagnosis method

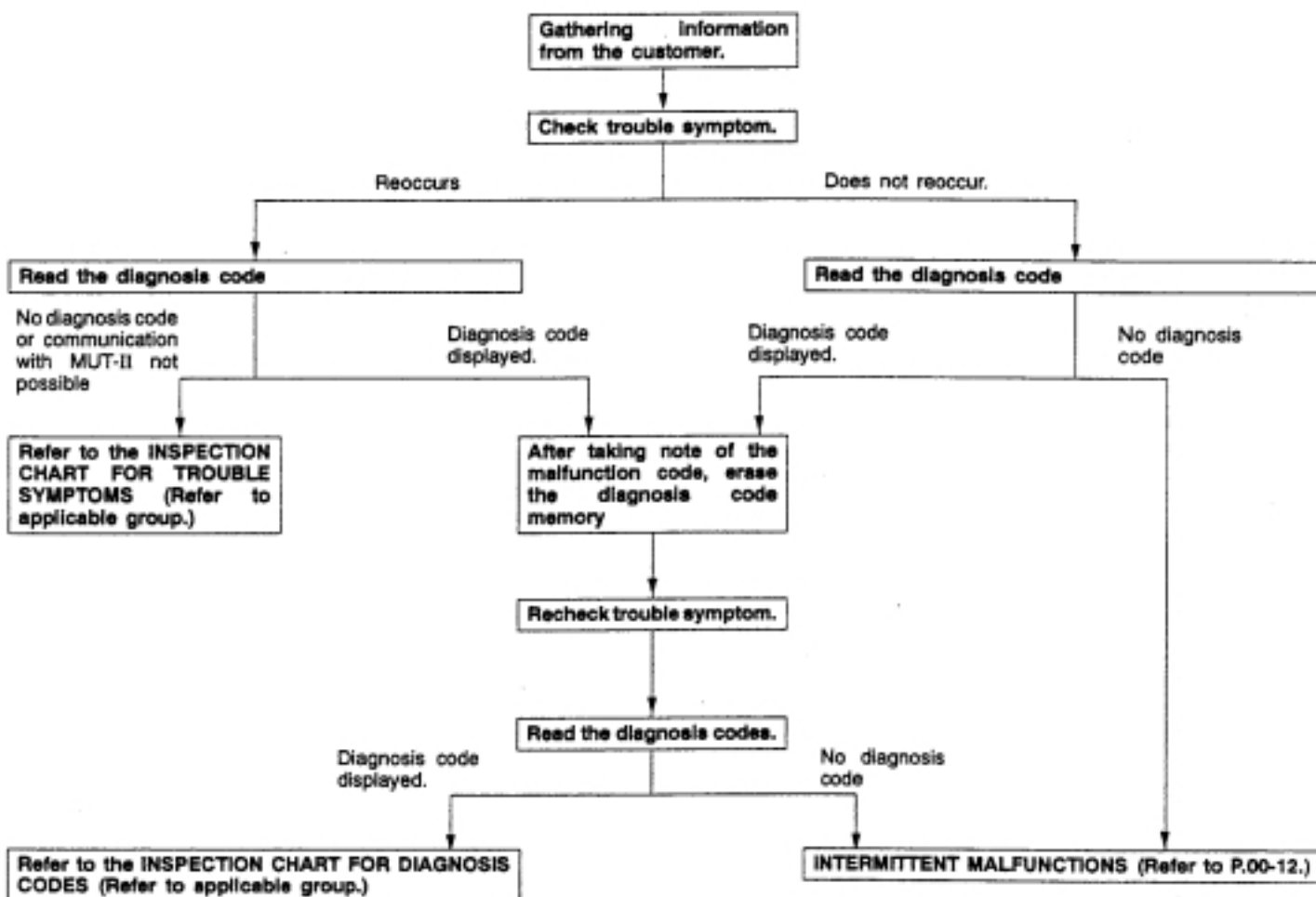

#### 2. SYSTEM OPERATION AND SYMPTOM VERIFICATION TESTS

If verification of the trouble symptoms is difficult, procedures for checking operation and verifying trouble symptoms are shown.

#### 3. DIAGNOSIS FUNCTION

Details which are different from those in the "Diagnosis Function" section on the next page are listed.

**4. INSPECTION CHART FOR DIAGNOSIS CODES****5. INSPECTION PROCEDURE FOR DIAGNOSIS CODES**

Indicates the inspection procedures corresponding to each diagnosis code. (Refer to P.00-9 for how to read the inspection procedures.)

**6. INSPECTION CHART FOR TROUBLE SYMPTOMS**

If there are trouble symptoms even though the results of inspection using the MUT-II show that all diagnosis codes are normal, inspection procedures for each trouble symptom will be found by means of this chart.

**7. INSPECTION PROCEDURE FOR TROUBLE SYMPTOM**

Indicates the inspection procedures corresponding to each trouble symptoms classified in the Inspection Chart for Trouble Symptoms. (Refer to P.00-9 for how to read the inspection procedures.)

**8. SERVICE DATA REFERENCE TABLE**

Inspection items and normal judgement values have been provided in this chart as reference information.

**9. CHECK AT ECU TERMINALS**

Terminal numbers for the ECU connectors, inspection items and standard values have been provided in this chart as reference information.

**10. INSPECTION PROCEDURES USING AN OSCILLOSCOPE**

When there are inspection procedures using an oscilloscope, these are listed here.

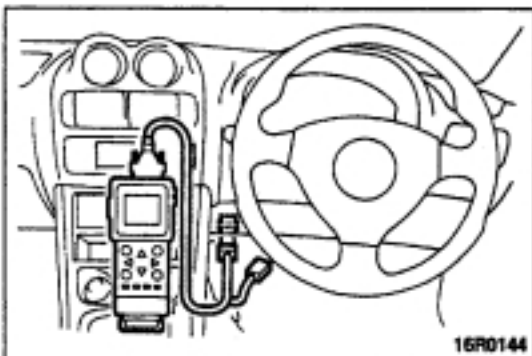
**DIAGNOSIS FUNCTION****METHOD OF READING DIAGNOSIS CODES  
WHEN USING THE MUT-II**

Connect the MUT-II to the diagnosis connector and take a reading of the diagnosis codes.

**Caution**

Turn off the ignition switch before connecting or disconnecting the MUT-II.

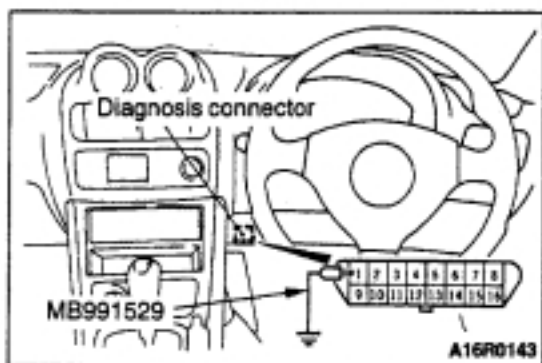

**WHEN USING THE WARNING LAMP**

1. Use the special tool to earth No.1 terminal (diagnosis control terminal) of the diagnosis connector.
2. To check ABS system, remove the valve relay.

**NOTE**

That is because the valve relay is off and the warning lamp remains illuminated if there is a fault in the ABS system.

3. Turn off the ignition switch.
4. Read out a diagnosis code by observing how the warning lamp flashes.

**Applicable systems**

System name	Warning lamp name
MPI	Engine warning lamp
A/T	Neutral position indicator lamp
ABS	ABS warning lamp
TCL	TCL-OFF indicator lamp

**Indication of diagnosis code by warning lamp**

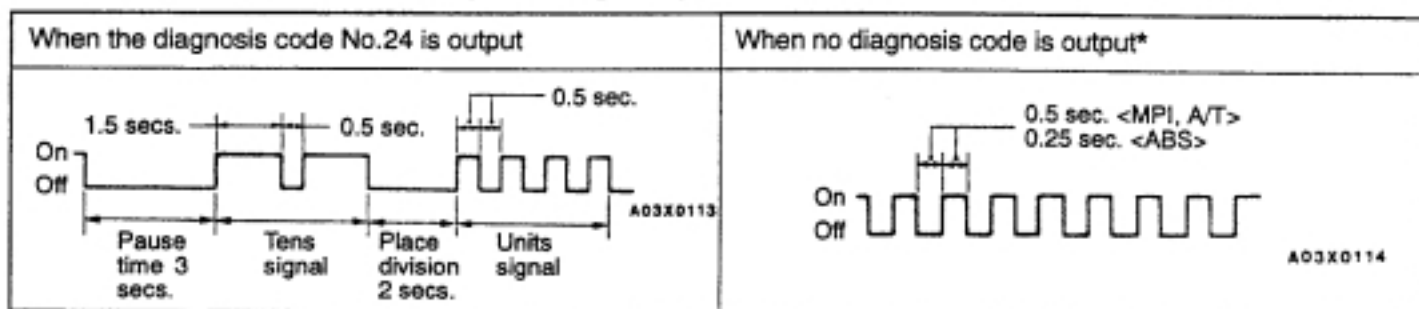

**NOTE**

\*: Even if the ABS system is normal, removing the valve relay causes the diagnosis code No.52 to be output.

**METHOD OF ERASING DIAGNOSIS CODES**

**WHEN USING THE MUT-II**

Connect the MUT-II to the diagnosis connector and erase the diagnosis code.

**Caution**

Turn off the ignition switch before connecting or disconnecting the MUT-II.

**WHEN NOT USING THE MUT-II**

- (1) Turn the ignition switch to OFF.
- (2) After disconnecting the battery cable from the battery (-) terminal for 10 seconds or more, reconnect the cable.
- (3) After the engine has warmed up, run it at idle for about 15 minutes.

## HOW TO USE THE INSPECTION PROCEDURES

The causes of a high frequency of problems occurring in electronic circuitry are generally the connectors, components, the ECU and the harnesses between connectors, in that order. These inspection procedures follow this order, and they first try to discover a problem with a connector or a defective component.

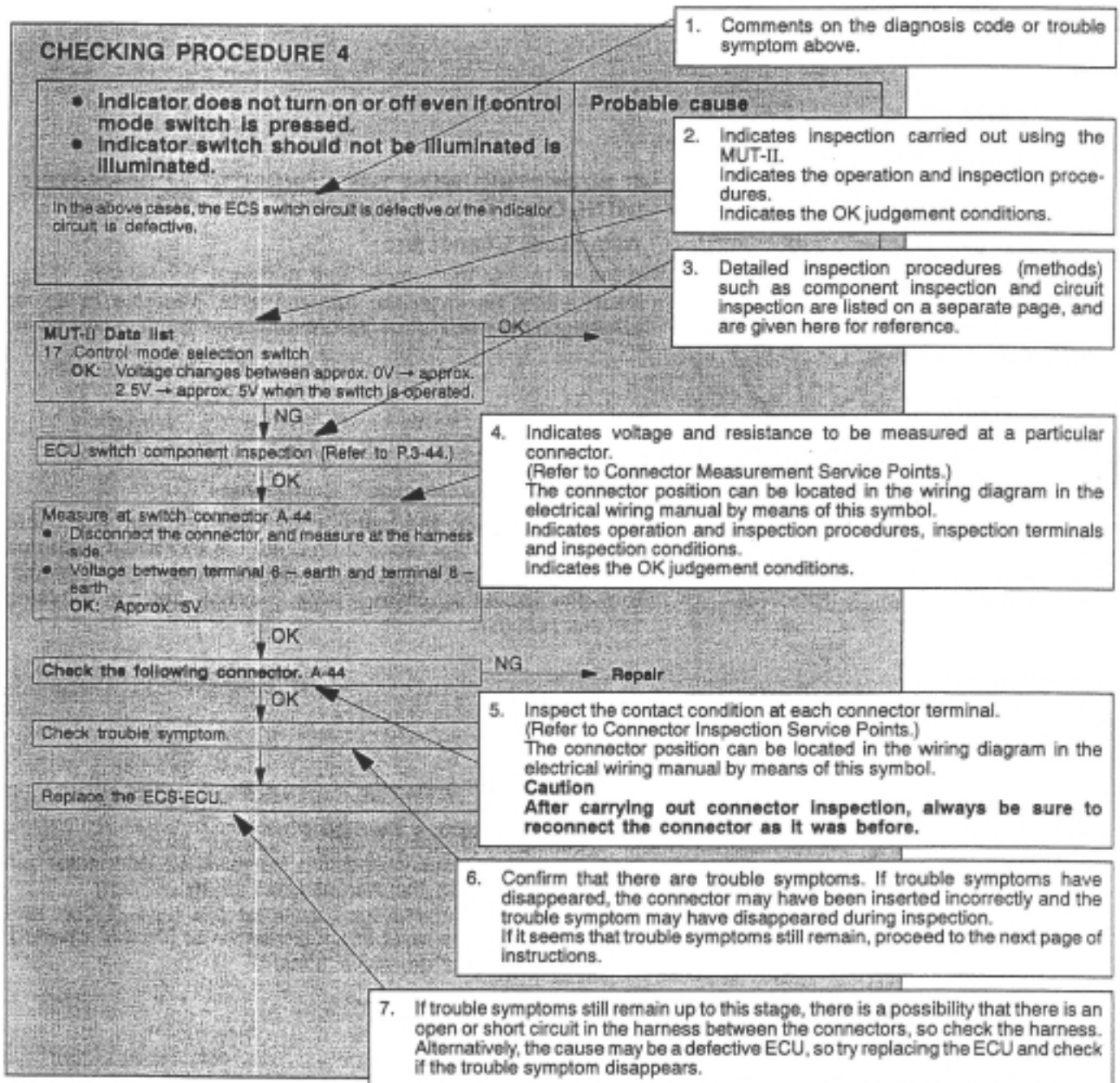

## HARNESS INSPECTION

Check for an open or short circuit in the harness between the terminals which were defective according to the connector measurements. Carry out this inspection while referring to the electrical wiring manual. Here, "Check harness between power supply and terminal xx" also includes checking for blown fuses. For inspection service points when there is a blown fuse, refer to "Inspection Service Points for a Blown Fuse."

## MEASURES TO TAKE AFTER REPLACING THE ECU

If the trouble symptoms have not disappeared even after replacing the ECU, repeat the inspection procedure from the beginning.

### CONNECTOR MEASUREMENT SERVICE POINTS

Turn the ignition switch to OFF when connecting/disconnecting the connectors, and turn the ignition switch to ON when measuring if there are no instructions to be contrary.

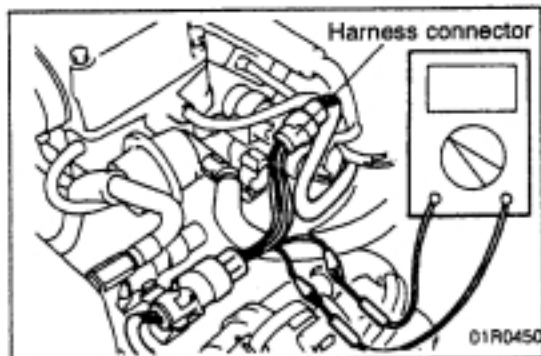

#### IF INSPECTING WITH THE CONNECTOR CONNECTED (WITH CIRCUIT IN A CONDITION OF CONTINUITY)

##### Waterproof Connectors

Be sure to use the special tool (harness connector). Never insert a test bar from the harness side, because to do so will reduce the waterproof performance and result in corrosion.

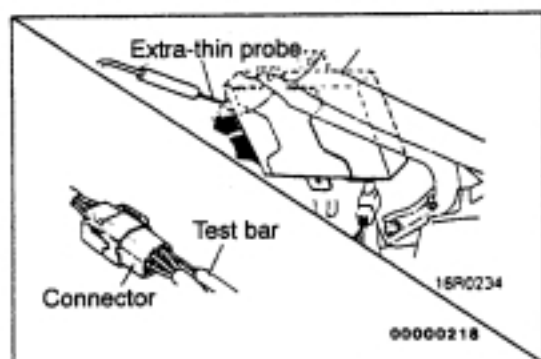

##### Ordinary (non-waterproof) Connectors

Check by inserting the test bar from the harness side. Note that if the connector (control unit, etc.) is too small to permit insertion of the test bar, it should not be forced; use a special tool (the extra-thin probe in the harness set for checking for this purpose).

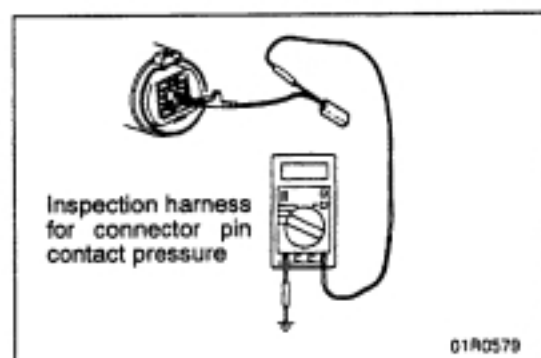

#### IF INSPECTING WITH THE CONNECTOR DISCONNECTED <When inspecting a Female Pin>

Use the special tool (inspection harness for connector pin contact pressure in the harness set for inspection). The inspection harness for connector pin contact pressure should be used. The test bar should never be forcibly inserted, as it may cause a defective contact.

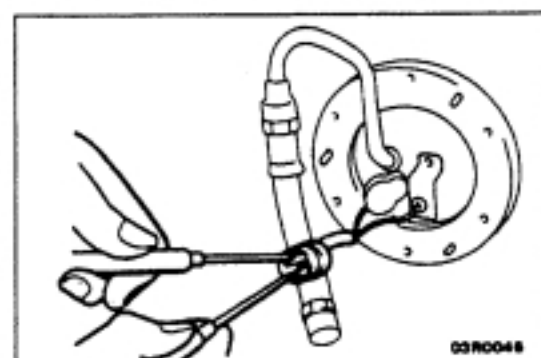

#### <When inspecting a Male Pin>

Touch the pin directly with the test bar.

##### Caution

At this time, be careful not to short the connector pins with the test bars. To do so may damage the circuits inside the ECU.

Connector disconnected or improperly connected

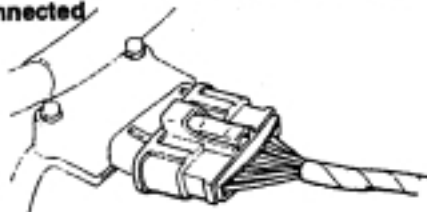

16S0256

Defective connector contact

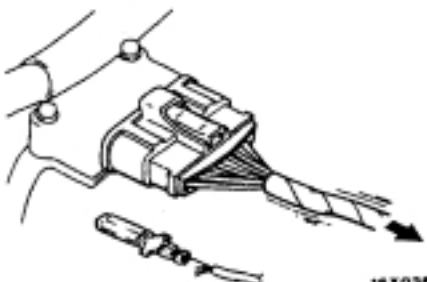

16X0369

Harness wire breakage at terminal section

Low contact pressure

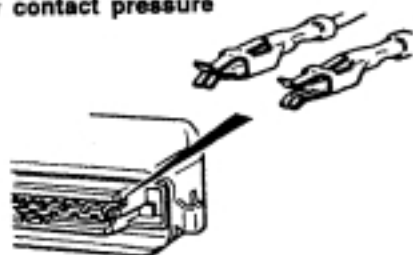

16S0254  
00000219

## CONNECTOR INSPECTION

### VISUAL INSPECTION

- Connector is disconnected or improperly connected
- Connector pins are pulled out
- Due to harness tension at terminal section
- Low contact pressure between male and female terminals
- Low connection pressure due to rusted terminals or foreign matter lodged in terminals

### CONNECTOR PIN INSPECTION

If the connector pin stopper is damaged, the terminal connections (male and female pins) will not be perfect even if the connector body is connected, and the pins may pull out of the reverse side of the connector. Therefore, gently pull the harnesses one by one to make sure that no pins pull out of the connector.

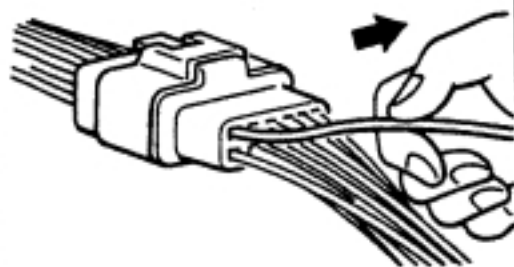

16R1317

### CONNECTOR ENGAGEMENT INSPECTION

Use the special tool (connector pin connection pressure inspection harness of the inspection harness set) to inspect the engagement of the male pins and females pins. (Pin drawing force : 1 N or more)

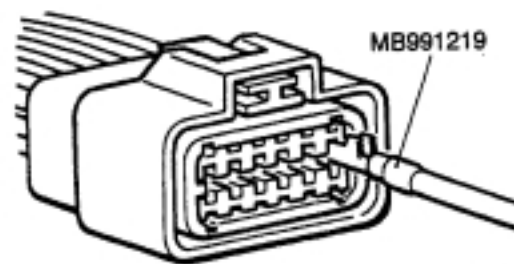

MB991219

16R1318

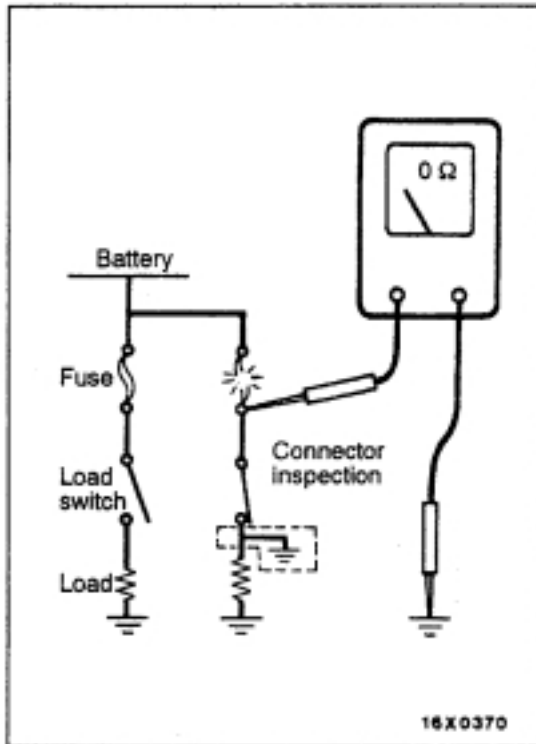

### INSPECTION SERVICE POINTS FOR A BLOWN FUSE

Remove the fuse and measure the resistance between the load side of the fuse and the earth. Set the switches of all circuits which are connected to this fuse to a condition of continuity. If the resistance is almost 0 Ω at this time, there is a short somewhere between these switches and the load. If the resistance is not 0 Ω, there is no short at the present time, but a momentary short has probably caused the fuse to blow.

The main causes of a short circuit are the following.

- Harness being clamped by the vehicle body
- Damage to the outer casing of the harness due to wear or heat
- Water getting into the connector or circuitry
- Human error (mistakenly shorting a circuit, etc.)

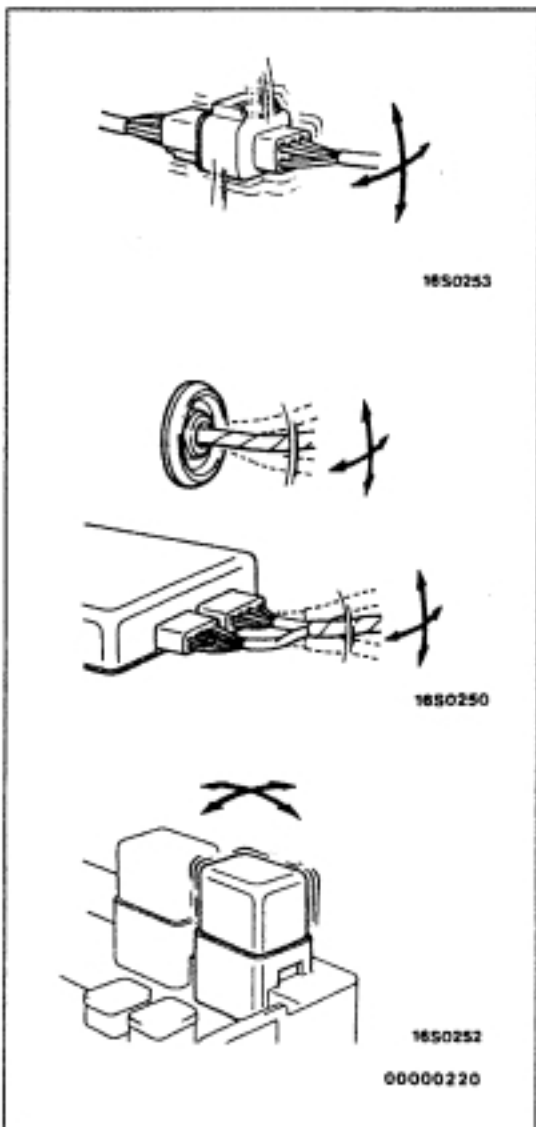

### POINTS TO NOTE FOR INTERMITTENT MALFUNCTIONS

Intermittent malfunctions often occur under certain conditions, and if these conditions can be ascertained, determining the cause becomes simple. In order to ascertain the conditions under which an intermittent malfunction occurs, first ask the customer for details about the driving conditions, weather conditions, frequency of occurrence and trouble symptoms, and then try to recreate the trouble symptoms. Next, ascertain whether the reason why the trouble symptom occurred under these conditions is due to vibration, temperature or some other factor. If vibration is thought to be the cause, carry out the following checks with the connectors and components to confirm whether the trouble symptom occurs.

The objects to be checked are connectors and components which are indicated by inspection procedures or given as probable causes (which generates diagnosis codes or trouble symptoms.)

- Gently shake the connector up, down and to the left and right.
- Gently shake the wiring harness up, down and to the left and right.
- Gently rock each sensor and relay, etc. by hand.
- Gently shake the wiring harness at suspensions and other moving parts.

#### NOTE

If determining the cause is difficult, the flight recorder function of the MUT-II can also be used.

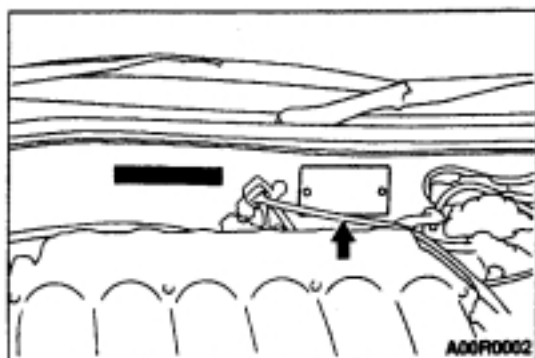

## VEHICLE IDENTIFICATION

### VEHICLE INFORMATION CODE PLATE

#### LOCATION

Vehicle information code plate is riveted on the toeboard inside the engine compartment.

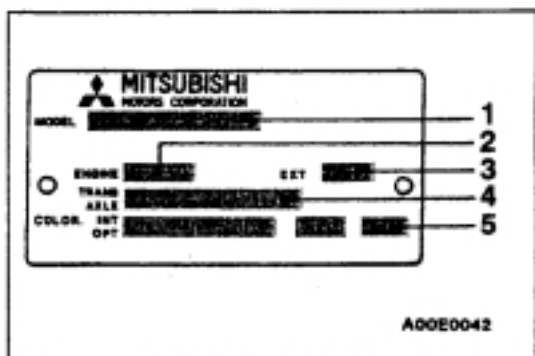

#### CODE PLATE DESCRIPTION

The plate shows model code, engine model, transmission model, and body colour code.

No.	Item	Contents	
1	MODEL	DE3A	DE3A: Vehicle model
		HNGHR	HNGHR: Model series
2	ENGINE	6A12	Engine model
3	EXT	A26	Exterior code
4	TRANS AXLE	F5M42	Transmission code
5	COLOR INT OPT	A2630JD62	A26: Body colour code
			30J: Interior code
			D62: Equipment code

For monotone colour vehicles, the body colour code shall be indicated.

## MODELS

Model code		Engine model	Transmission model	Fuel supply system
DE3A	HNGHR	6A12 <V6-MIVEC> (1,998 ml)	F5M42 (2WD-5M/T)	MPI
	HYGHR		F5A42 (2WD-5A/T)	



<b>D</b>	<b>E</b>	<b>3</b>	<b>A</b>	<b>H</b>	<b>N</b>	<b>G</b>	<b>H</b>	<b>R</b>
1	2	3	4	5	6	7	8	9

00F0016

**MODEL CODE**

No.	Items	Contents
1	Vehicle line	D: FTO
2	Drive system	E: 2WD
3	Engine type	3: 1,998 m <sup>l</sup> petrol engine (6A12 <V6-MIVEC>)
4	Group	A: Passenger car
5	Body style	H: 2-door notchback coupe
6	Transmission type	N: 5-speed manual transmission Y: 5-speed automatic transmission
7	Vehicle grade	G: GPX
8	Specified engine feature	H: MPI-DOHC-MIVEC
9	Steering wheel location	R: Right hand

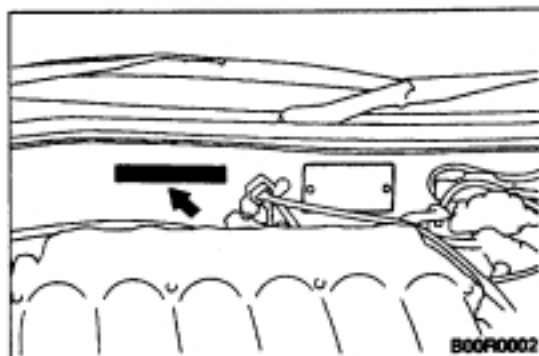
**CHASSIS NUMBER**

The chassis number is stamped on the toeboard inside the engine compartment.

▲ J M Y H N DE 3 A W U 000001 ▲  
 1 2 3 4 5 6 7 8 9 10 11

A00R0017

No.	Items	Contents
1	Fixed figure	J Asia
2	Distribution channel	M Japan channel
3	Destination	Y For General Export
4	Body style	H 2-door notchback coupe
5	Transmission type	N 5-speed manual transmission
		Y 5-speed automatic transmission
6	Development order	DE FTO
7	Engine	3 6A12: 1,998 mℓ petrol engine
8	Sort	A Passenger car
9	Model year	W 1998
10	Plant	U Mizushima Motor Vehicle Works
11	Serial number	–

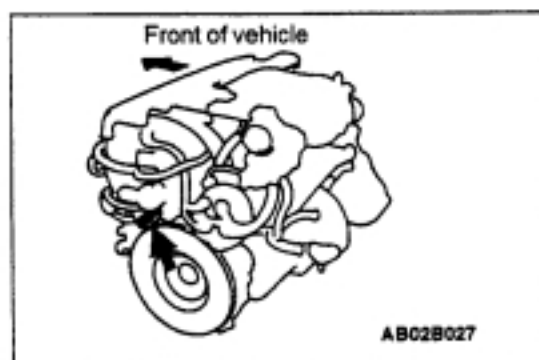
**ENGINE MODEL NUMBER**

- The engine model number is stamped at the cylinder block as shown in the following.

Engine model	Engine displacement mℓ
6A12	1998

- The engine serial number is stamped near the engine model number.

Engine serial number	AA0201 to YY9999
----------------------	------------------

## MAJOR SPECIFICATIONS

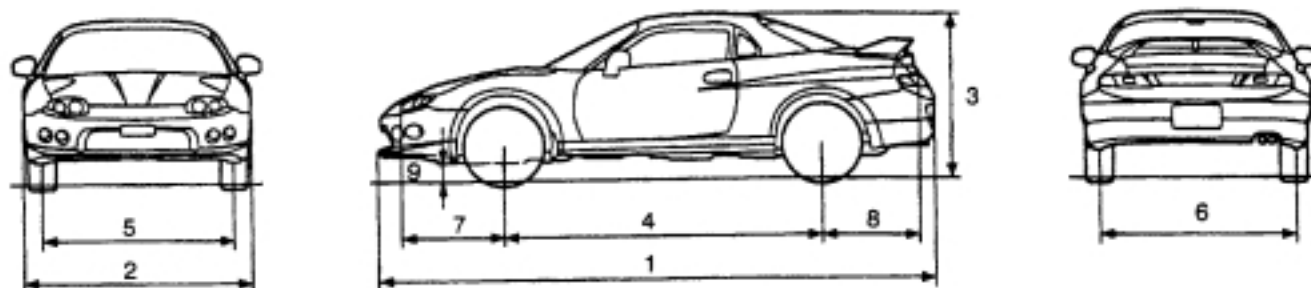

P01A062

Items		DE3AHNGHR	DE3AHYGHR
Vehicle dimensions mm	Overall length	1	4,365
	Overall width	2	1,735
	Overall height (unladen)	3	1,300, 1,305*
	Wheelbase	4	2,500
	Track-front	5	1,490
	Track-rear	6	1,485
	Overhang-front	7	800
	Overhang-rear	8	795
	Ground clearance (unladen)	9	150
Vehicle weight kg	Kerb weight	1,200	
	Max. gross vehicle weight	1,590	
	Max. axle weight rating-front	930	
	Max. axle weight rating-rear	660	
Seating capacity		4	
Engine	Model No.	6A12	
	Total displacement ml	1,998	
Transmission	Model No.	F5M42	F5A42
	Type	5-speed manual	5-speed automatic
Fuel system	Fuel supply system	MPI	

NOTE: \* indicates vehicles equipped with sunroof.

## PRECAUTIONS BEFORE SERVICE

### SUPPLEMENTAL RESTRAINT SYSTEM (SRS)

1. Items to follow when servicing SRS
  - (1) Be sure to read GROUP 52B – Supplemental Restraint System (SRS).  
For safe operations, please follow the directions and heed all warnings.
  - (2) Wait at least 60 seconds after disconnecting the battery cable before doing any further work.  
The SRS system is designed to retain enough voltage to deploy the air bag even after the battery has been disconnected. Serious injury may result from unintended air bag deployment if work is done on the SRS system immediately after the battery cable is disconnected.
  - (3) Warning labels must be heeded when servicing or handling SRS components. Warning labels are located in the following locations.
    - Sun visor
    - SRS air bag control unit (SRS-ECU)
    - Steering wheel
    - Steering gear and linkage
    - Air bag module (driver's side and front passenger's side)
    - Clock spring
  - (4) Always use the designated special tools and test equipment.
  - (5) Store components removed from the SRS in a clean and dry place.  
The air bag module should be stored on a flat surface and placed so that the pad surface is facing upward.  
Do not place anything on top of it.
  - (6) Never attempt to disassemble or repair the SRS components (SRS-ECU, air bag module and clock spring). If faulty replace them.
  - (7) Whenever you finish servicing the SRS, check the SRS warning lamp operation to make sure that the system functions properly.
  - (8) Be sure to deploy the air bag before disposing of the air bag module or disposing of a vehicle equipped with an air bag. (Refer to GROUP 52B – Air Bag Module Disposal Procedures.)
2. Observe the following when carrying out operations on places where SRS components are installed, including operations not directly related to the SRS air bag.
  - (1) When removing or installing parts do not allow any impact or shock to the SRS components.
  - (2) SRS components should not be subjected to heat over 93°C, so remove the SRS components before drying or baking the vehicle after painting.  
After re-installing them, check the SRS warning lamp operation to make sure that the system functions properly.