

BACKUP Service Manual

ENGINE

1992 – 1993

GROUP INDEX

FOREWORD

The information contained in this service manual has been prepared for the professional automotive technician involved in daily repair operations. Information in this manual is divided into groups by engine models. Each group is further divided to address individual components within the group. These groups contain general information, specification, removal and installation, disassembly and reassembly procedures for the components. The first page of each group contains an alphabetical index to assist in finding the location of the component. The information, descriptions and specifications were in effect at the time this manual was released.

Introduction

Engine

4G1

4G3

4G6 <1992>

4G9

6G7

4G6 <1993>

11A

11B

11C

11D

11E

11F

WE SUPPORT
VOLUNTARY TECHNICIAN
CERTIFICATION THROUGH

National Institute for
AUTOMOTIVE
SERVICE
EXCELLENCE



Mitsubishi Motors Corporation reserves the right to make changes in design or to make additions to or improvements in its products without imposing any obligations upon itself to install them on its products previously manufactured.

100-1000

100-1000

100-1000

100-1000

100-1000

100-1000

100-1000

100-1000

100-1000

100-1000

100-1000

100-1000

100-1000

100-1000

100-1000

EXPLANATION OF MANUAL CONTENTS

Maintenance and Servicing Procedures

- (1) A diagram of the component parts is provided near the front of each section in order to give the reader a better understanding of the installed condition of component parts.
- (2) The numbers provided within the diagram indicate the sequence for maintenance and servicing procedures; the symbol **N** indicates a non-reusable part; the tightening torque is provided where applicable.

- **Removal steps:**
The part designation number corresponds to the number in the illustration to indicate removal steps.
- **Disassembly steps:**
The part designation number corresponds to the number in the illustration to indicate disassembly steps.
- **Installation steps:**
Specified in case installation is impossible in reverse order of removal steps. Omitted if installation is possible in reverse order of removal steps.
- **Reassembly steps:**
Specified in case reassembly is impossible in reverse order of disassembly steps. Omitted if reassembly is possible in reverse order of disassembly steps.





Classification of Major Maintenance/Service Points

When there are major points relative to maintenance and servicing procedures (such as essential maintenance and service points, maintenance and service standard values, information regarding the use of special tools, etc.), these are arranged together as major maintenance and service points and explained in detail.

- ◁A▷: Indicates that there are essential points for removal or disassembly.
- ◆A◆: Indicates that there are essential points for installation or reassembly.

Symbols for Lubrication, Sealants and Adhesives

Information concerning the locations for lubrication and for application of sealants and adhesives is provided, by using symbols, in the diagram of component parts, or on the page following the component parts page, and explained.

-  . . Grease
(multipurpose grease unless there is a brand or type specified)
-  Sealant or adhesive
-  Brake fluid, automatic transmission fluid or air conditioning compressor oil
-  Engine oil or gear oil

Indicates the group number.
 Indicates the page number.
 Indicates the group title.
 Indicates the section title.

11A-28 4G3 ENGINE - Intake Manifold

**INTAKE MANIFOLD
 REMOVAL AND INSTALLATION**

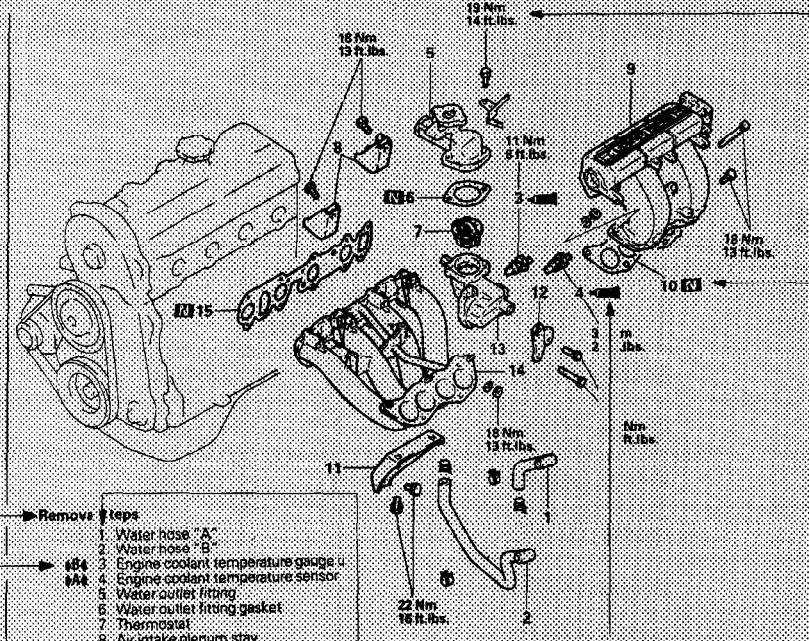

Denotes tightening torque.

Denotes non-reusable part.

- Remove Steps**
1. Water hose "A"
 2. Water hose "B"
 3. Engine coolant temperature gauge
 4. Engine coolant temperature sensor
 5. Water outlet fitting
 6. Water outlet fitting gasket
 7. Thermostat
 8. Air intake plenum stay
 9. Air intake plenum
 10. Air intake plenum gasket
 11. Intake manifold stay
 12. Intake manifold gasket
 13. Intake manifold
 14. Intake manifold gasket
 15. Intake manifold gasket

This number corresponds to the number appearing in "Removal steps", "Disassembly steps", "Installation steps" or "Reassembly steps"

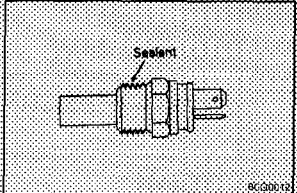

INSTALLATION SERVICE POINTS

1A SEALANT APPLICATION TO ENGINE COOLANT TEMPERATURE SENSOR.

Specified sealant:
 2M Nut Locking Part No. 4171 or equivalent

Operating procedures, cautions, etc. on removal, installation, disassembly and reassembly are described.

TSB Revision

ENGINE MODEL TABLE – 1992

Engine Series,	Engine Model	Displacement Liters (cu.in.)	Type	No. of Valves (per cylinder)	Vehicle Model
4G1	4G15	1.5 (92)	In-line, SOHC	3	Mirage
4G3	4G37	1.8 (110)	In-line, SOHC	2	Eclipse
4G6	4G61	1.6 (98)	In-line, DOHC	4	Mirage
	4G63	2.0 (122)	In-line, SOHC	2	Galant
	4G63	2.0 (122)	In-line, DOHC	4	Galant, Eclipse
	4G63 Turbo	2.0 (122)	In-line, DOHC	4	Galant, Exlipse
	4G64	2.4 (146)	In-line, SOHC	2	Expo, Truck
4G9	4G93	1.8 (110)	In-line, SOHC	4	Expo LRV
6G7	6G72	3.0 (183)	60°V, SOHC (per bank)	2	Diamante, Montero, Truck
	6G72	3.0 (183)	60°V, DOHC (per bank)	4	Diamante, 3000GT
	6G72 Turbo	3.0 (183)	60°V, DOHC (per bank)	4	3000GT

ENGINE MODEL TABLE – 1993

Engine Series	Engine Model	Displacement Liters (cu.in.)	Type	No. of Valves (per cylinder)	Vehicle Model
4G1	4G15	1.5 (92)	In-line, SOHC	3	Mirage
4G3	4G37	1.8 (110)	In-line, SOHC	2	Eclipse
4G6	4G63	2.0 (122)	In-line, SOHC	4	Galant
	4G63	2.0 (122)	In-line, DOHC	4	Galant, Eclipse
	4G63 Turbo	2.0 (122)	In-line, DOHC	4	Galant, Exlipse
	4G64	2.4 (146)	In-line, SOHC	2	Truck
	4G64	2.4 (146)	In-line, SOHC	4	Expo-LRV, Expo
4G9	4G93	1.8 (110)	In-line, SOHC	4	Mirage, Expo LRV
6G7	6G72	3.0 (183)	60°V, SOHC (per bank)	2	Diamante, Montero, Truck
	6G72	3.0 (183)	60°V, DOHC (per bank)	4	Diamante, 3000GT
	6G72 Turbo	3.0 (183)	60°V, DOHC (per bank)	4	3000GT

SPECIAL TOOL NOTE

Please refer to the special tool cross reference chart which is located in the service manual at the beginning of each group, for a cross reference from the MMC special tool number to the special tool number that is available in your market.

TORQUE REFERENCES

General tightening torque is as shown in the following table.

The specific part tightening torque is shown at the beginning of each group.

Size mm (dia. x pitch)	Bolt with spring washer						Flange bolt			
	Head mark 4		Head mark 7		Head mark 10		Head mark 4		Head mark 7	
	Nm	ft.lbs.	Nm	ft.lbs.	Nm	ft.lbs.	Nm	ft.lbs.	Nm	ft.lbs.
5 x 0.8	–	–	5.0	4	–	–	–	–	6.0	4
6 x 1.0	–	–	9.0	7	13	9	–	–	11	8
8 x 1.25	11	8	18	13	30	22	14	10	24	17
10 x 1.25	20	14	34	25	60	43	30	22	50	36
12 x 1.25	36	26	62	45	108	78	55	40	90	65
14 x 1.5	55	40	92	67	175	127	–	–	–	–

NEW TIGHTENING METHOD – BY USE OF BOLTS TO BE TIGHTENED IN PLASTIC AREA

A new type of bolts, to be tightened in plastic area, is currently used in some parts of the engine. The tightening method for the bolts is different from the conventional one. Be sure to observe the method described in the text when tightening the bolts.

Service limits are provided for the bolts. Make sure that the service limits described in the text are strictly observed.

- Areas where the bolts are in use:

- (1) Cylinder head bolts
- (2) Main bearing cap bolts
- (3) Connecting rod cap bolts

Remarks:

The bolts in (1) and (2) apply to the 4G6 <1993> and 4G93 engines.

The bolts in (3) apply to the 4G15, 4G6 <1993> and 4G93 engines.

- Tightening Method

After tightening the bolts to the specified torque, tighten them another 90° or 180° (twice 90°). The tightening method varies on different areas. Observe the tightening method described in the text.

FORM-IN-PLACE GASKET

The engine has several areas where the form-in-place gasket (FIPG) is in use. To ensure that the gasket fully serves its purpose, it is necessary to observe some precautions when applying the gasket. Bead size, continuity and location are of paramount importance. Too thin a bead could cause leaks. Too thick a bead, on the other hand, could be squeezed out of location, causing blocking or narrowing of the fluid feed line. To eliminate the possibility of leaks from a joint, therefore, it is absolutely necessary to apply the gasket evenly without a break, while observing the correct bead size.

The FIPG used in the engine is a room temperature vulcanization (RTV) type and is supplied in a 100-gram tube (Part No. MD970389 or MD997110). Since the RTV hardens as it reacts with the moisture in the atmospheric air, it is normally used in the metallic flange areas. The FIPG, Part No. MD970389, can be used for sealing both engine oil and coolant, while Part No. 997110 can only be used for engine oil sealing.

Disassembly

The parts assembled with the FIPG can be easily disassembled without use of a special method. In some cases, however, the sealant between the joined surfaces may have to be broken by lightly striking with a mallet or similar tool. A flat gasket scraper may be lightly hammered in between the joined surfaces. In this case, however, care must be taken to prevent damage to the joined surfaces.

Surface Preparation

Thoroughly remove all substances deposited on the gasket application surfaces, using a gasket scraper or wire brush. Check to ensure that the surfaces to which the FIPG is to be applied is flat. Make sure that there are no oils, greases and foreign substances deposited on the application surfaces. Do not forget to remove the old sealant remaining in the bolt holes.

Form-In-Place Gasket Application

When assembling parts with the FIPG, you must observe some precautions, but the procedure is very simple as in the case of a conventional precut gasket.

Applied FIPG bead should be of the specified size and without breaks. Also be sure to encircle the bolt hole circumference with a completely continuous bead. The FIPG can be wiped away unless it is hardened. While the FIPG is still moist (in less than 15 minutes), mount the parts in position. When the parts are mounted, make sure that the gasket is applied to the required area only.

The FIPG application procedure may vary on different areas. Observe the procedure described in the text when applying the FIPG.

ENGINE

4G15

CONTENTS

BRACKET	53	INTAKE MANIFOLD	26
CRANKSHAFT, FLYWHEEL AND DRIVE PLATE	51	PISTON AND CONNECTING ROD	43
CYLINDER HEAD AND VALVES	33	ROCKER ARMS AND CAMSHAFT	30
EXHAUST MANIFOLD AND WATER PUMP	28	SEALANT	11
FRONT CASE AND OIL PUMP	39	SERVICE SPECIFICATIONS	6
FUEL AND EMISSION PARTS	22	SPECIAL TOOLS	12
GENERAL INFORMATION	2	THROTTLE BODY	24
GENERAL SPECIFICATIONS	5	TIMING BELT	17
GENERATOR AND IGNITION SYSTEM	14	TORQUE SPECIFICATIONS	10

GENERAL INFORMATION

ENGINE SECTIONAL VIEW

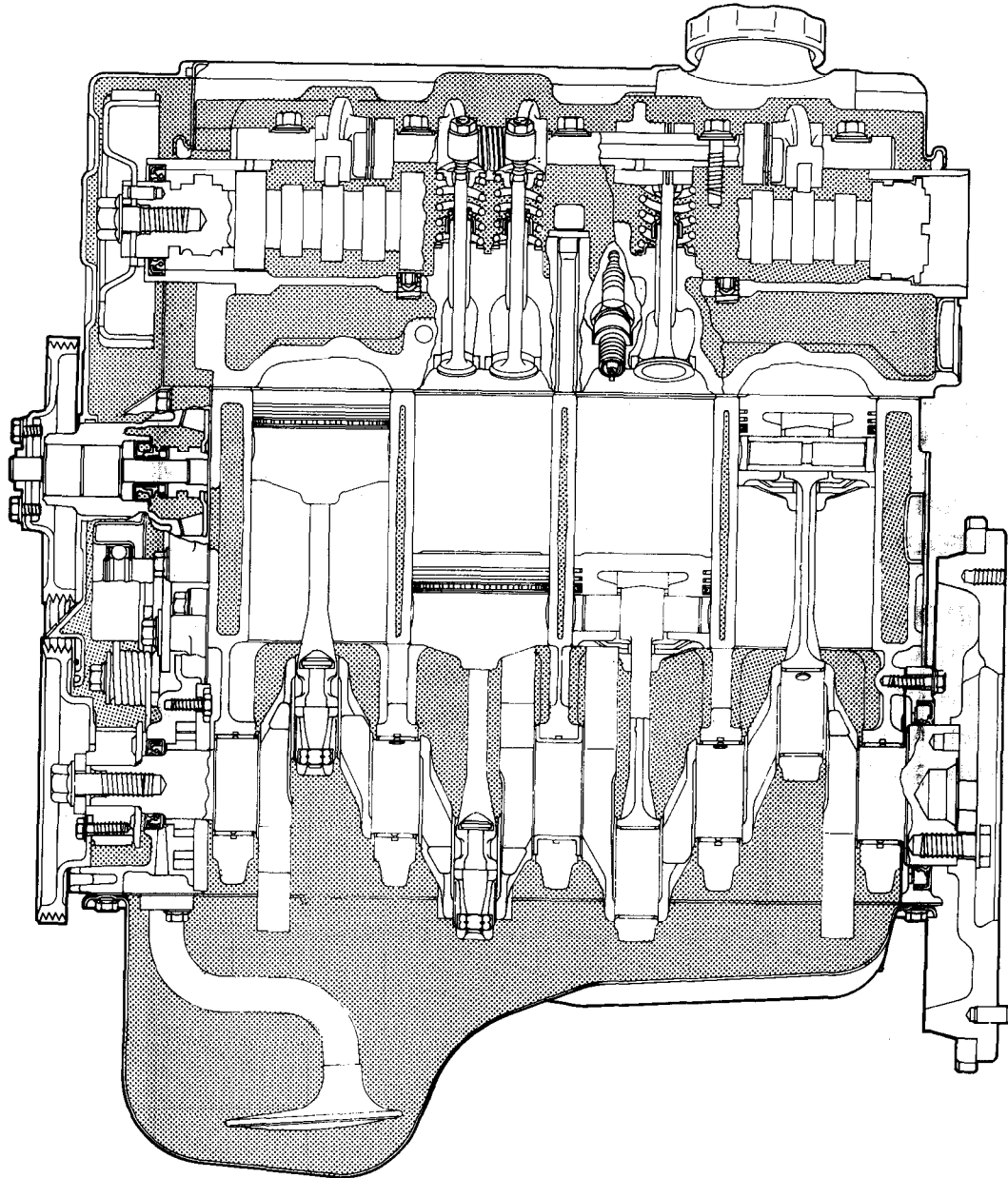

3501470000 (TAZ31RBU)

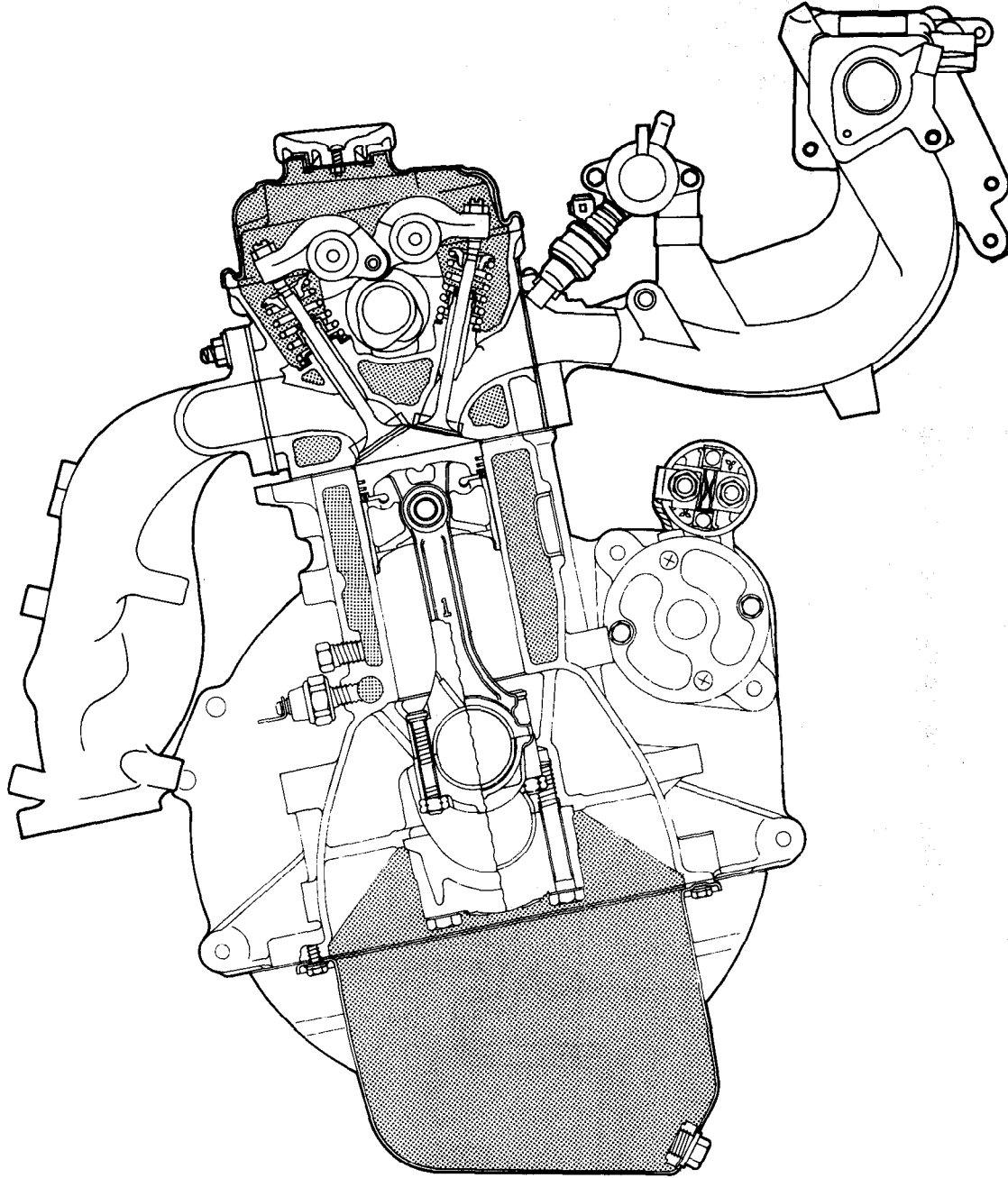

LUBRICATION SYSTEM

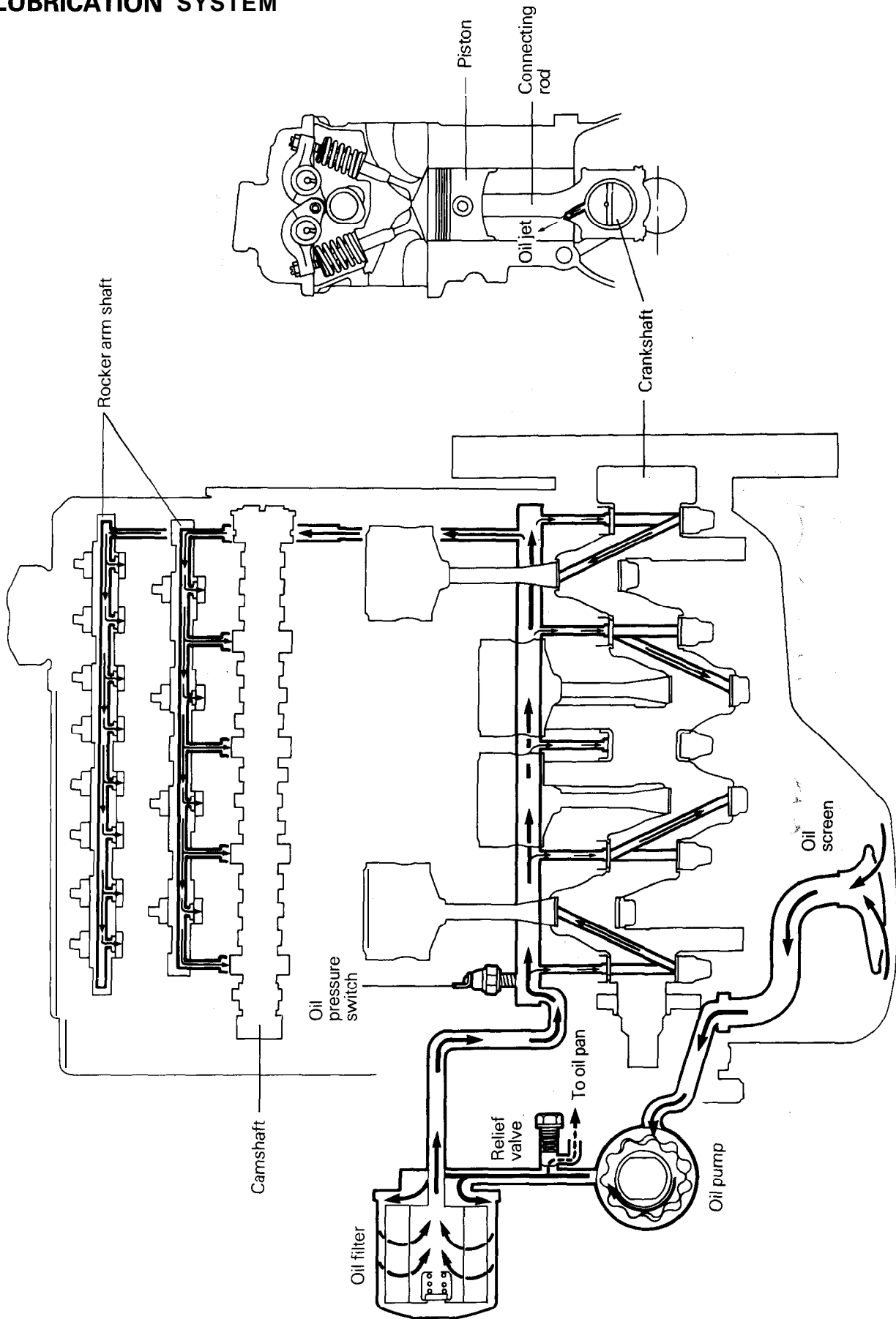

GENERAL SPECIFICATIONS

Items	Specifications
Type	In-line OHV, SOHC
Number of cylinders	4
Combustion chamber	Pentroof type
Total displacement cm ³ (cu.in.)	1,468 (89.58)
Cylinder bore mm (in.)	75.5 (2.972)
Piston stroke mm (in.)	82 (3.228)
Compression ratio	9.2
Valve timing	
() : Camshaft identification mark	(1)* ¹ (6)* ²
Intake valve	
Opens BTDC	14" 15"
Closes ABDC	51" 53"
Exhaust valve	
Opens BBDC	51" 57"
Closes ATDC	14" 15"
Lubrication system	Pressure feed, full-flow filtration
Oil pump type	Trochoid type
Cooling system	Water-cooled forced circulation
Water pump type	Centrifugal impeller type
EGR valve	Single type
Injector type and number	Electromagnetic, 4
Injector identification No.	BDH182
Fuel regulated pressure kpa (psi)	335 (47.6)
Throttle bore mm (in.)	46 (1.811)
Throttle position sensor	Variable resistor type
Closed throttle position switch	Contact type, within idle speed control motor* ¹ Movable contact type within throttle position sensor* ²

*1: Up to 1992 models

*2: From 1993 models

SERVICE SPECIFICATIONS

mm (in.)

Items	Standard value	Limit
Cylinder head		
Flatness of gasket surface	0.05 (.0020)	0.2 (.008)
Grinding limit of gasket surface		0.2 (.008)
† Total resurfacing depth of both cylinder head and cylinder block		
Overall height	106.9 – 107.1 (4.209 – 4.217)	
Oversize rework dimensions of valve guide hole (both intake and exhaust)		
0.05 (.002)	12.05 – 12.07 (.4744 – .4752)	
0.25 (.010)	12.25 – 12.27 (.4823 – .4831)	
0.50 (.020)	12.50 – 12.52 (.4921 – .4929)	
Oversize rework dimensions of intake valve seat ring hole (primary)		
0.3 (.012)	27.42 – 27.44 (1.0795 – 1.0803)	
0.6 (.024)	27.72 – 27.74 (1.0913 – 1.0922)	
Oversize rework dimensions of intake valve seat ring hole (secondary)		
0.3 (.012)	32.43-32.45 (1.2768 – 1.2776)	
0.6 (.024)	32.73-32.75 (1.2886 – 1.2894)	
Oversize rework dimensions of exhaust valve seat ring hole		
0.3 (.012)	35.43 – 35.45 (1.3949 – 1.3957)	
0.6 (.024)	35.73 – 35.75 (1.4067 – 1.4075)	
Camshaft		
Cam height		
Intake	38.78 (1.5268)	38.28 (1.5071)
Exhaust	39.10 (1.5394)	38.60 (1.5197)
Journal diameter	45.93 – 45.94 (1.8083 – 1.8087)	
Oil clearance	0.06 – 0.10 (.0024 – .0039)	
Rocker arm		
.D.	18.91 – 18.93 (.7445 – .7453)	
Rocker arm-to-shaft clearance	0.01 – 0.04 (.0004 – .0016)	0.1 (.004)
Rocker arm shaft		
.D.	18.89 – 18.90 (.7437 – .7441)	
Overall length		
Intake	365 (14.37)	
Exhaust	346 (13.62)	

mm (in.)

Items	Standard value	Limit
Valve		
Overall length		
Intake	100.75 (3.9665)	
Exhaust	101.05 (3.9783)	
Stem diameter		
Intake	6.57 – 6.58 (.2587 – .2591)	
Exhaust	6.53 – 6.55 (.2571 – .2579)	
Face angle	45° – 45°30'	
Thickness of valve head (margin)		
Intake	1.0 (.039)	0.5 (.020)
Exhaust	1.5 (.059)	1.0 (.039)
Stem-to-guide clearance		
Intake	0.02 – 0.05 (.0008 – .0020)	0.10 (.0039)
Exhaust	0.05 – 0.09 (.0020 – .0035)	0.15 (.0059)
Valve clearance		
Intake	0.07 (.0028) Up to 1992 models 0.09 (.0035) From 1993 models	
Exhaust	0.17 (.0067)	
Valve spring		
Free height		
Intake	46.1 (1.815)	45.1 (1.776)
Exhaust	46.8 (1.843)	45.8 (1.803)
Load/installed height N/mm (lbs./in.)		
Intake	230/40 (51/1.57)	
Exhaust	290/40 (64/1.57)	
Out-of-squareness	Max. 2°	4°
Valve guide		
Overall length		
Intake	44 (1.732)	
Exhaust	49.5 (1.949)	
I.D.	6.60 – 6.62 (.2598 – .2606)	
O.D.	12.055 – 12.065 (.4746 – .4750)	
Service size	0.05 (.002), 0.25 (.01), 0.50 (.02) oversize	
Press-in temperature	Room temperature	
Valve seat		
Seat angle	43°30' – 44°	
Valve contact width	0.9 – 1.3 (.035 – .051)	
Sinkage		0.2 (.008)
Service size	0.3 (.012), 0.6 (.024) oversize	

mm (in.)

Items	Standard value	Limit
Piston O.D. Piston-to-cylinder clearance Service size	75.48 – 75.50 (2.9716 – 2.9724) 0.02 – 0.04 (.0008 – .0016) 0.25 (.01), 0.50 (.02), 0.75 (.03), 1 .00 (.04) oversize	
Piston ring End gap No. 1 ring No. 2 ring Oil ring Ring-to-ring groove clearance No. 1 ring No. 2 ring Service size	0.20 – 0.40 (.0079 – .0157) 0.20 – 0.35 (.0079 – .0138) 0.20 – 0.70 (.0079 – .0276) 0.03 – 0.07 (.0012 – .0028) 0.02 – 0.06 (.0008 – .0024) 0.25 (.01), 0.50 (.02), 0.75 (.03), 1 .00 (.04) oversize	0.8 (.031) 0.8 (.031) 1.0 (.039) 0.1 (.004) 0.1 (.004)
Piston pin O.D. Press-in load N (psi) Press-in temperature	18.003 – 18.005 (.7088 – .7089) 5,000 – 15,000 (1,102 – 3,307) Room temperature	
Connecting rod Big end center-to small end center length Bend Twist Big end side clearance	130.95 – 131.05 (5.1555-5.1594) 0.05 (.0020) 0.1 (.004) 0.10 – 0.25 (.0039 – .0098)	0.4 (.016)
Crankshaft End play Journal O.D. Pin O.D. Out-of-roundness and taper of journal and pin Oil clearance of journal Oil clearance of pin	0.05 – 0.18 (.0020 – .0071) 48 (1.89) 42 (1.65) 0.005 (.0002) 0.02 – 0.05 (.0008 – .0020) 0.02 – 0.05 (.0008 – .0020)	0.3 (.012) 0.1 (.004) 0.1 (.004)
Cylinder block .D. Flatness of gasket surface Grinding limit of gasket surface Total resurfacing depth of both cylinder block and cylinder head Overall height	75.50 – 75.53 (2.9724 – 2.9736) 0.05 (.002) 255.9 – 256.1 (10.075 – 10.083)	0.1 (.004) *0.2 (.008)

mm (in.)

Items	Standard value	Limit
Oil pump Tip clearance Side clearance Body clearance	0.03 – 0.08 (.0012 – .0031) 0.04 – 0.10 (.0016 – .0039) 0.10 – 0.18 (.0039 – .0071)	0.35 (.0138)
Drive belt deflection New belt Used belt	5.5 -7.0 (.22 – .28) 8.0 (.32)	
Injector Coil resistance Ω	13 – 16 at 20°C (68°F)	
Throttle position sensor Resistance $k\Omega$	3.5-6.5	
Idle speed control motor Coil resistance Ω	5 – 35 at 20°C (68°F)	
Idle air control motor Coil resistance Ω	28 – 33 at 20°C (68°F)	
Idle speed control motor position sensor Resistance $k\Omega$	4 - 6	

TORQUE SPECIFICATIONS



	Nm	ft.lbs.
Generator and ignition system		
Oil level gauge guide mounting bolt	11	8
Water pump pulley bolt	9	7
Generator brace bolt	14	10
Generator brace mounting bolt	24	17
Generator pivot nut	23	17
Crankshaft bolt	85	61
Crankshaft pulley bolt	14	10
Spark plug	25	18
Distributor	12	9
Timing belt		
Engine support bracket, left	36	26
Tensioner bolt	24	17
Camshaft sprocket bolt	70	51
Fuel and emission parts		
Throttle body mounting bolts	19	14
Fuel rail mounting bolts	12	9
Fuel regulator bolts	9	7
EGR valve (California) mounting bolts	13	9
Throttle body		
Throttle position sensor attaching bolts	2.0	1.5
Intake manifold		
Cable bracket bolt	14	11
Engine coolant temperature gauge unit	11	8
Engine coolant temperature sensor	30	22
Thermo switch	8	6
Water outlet fitting bolt	19	14
Thermostat housing bolt and nut	18	13
Intake manifold stay bolt	22	16
Engine support bracket stay	36	26
Intake manifold bolt and nut	18	13
Exhaust manifold and water pump		
Exhaust manifold cover "A" bolt	30	22
Exhaust manifold cover "A" and "B" mounting bolt	9	7
Exhaust manifold cover "B" bolt	24	18
Exhaust manifold nut	18	13
Water inlet pipe bolt	14	11
Water pump bolt	14	11
Oxygen sensor	45	33
Locker arms and camshaft		
Locker cover bolt	1.8	1.3
Locker arm shaft bolt	32	24
Locker arm lock nut	15	11

	N m	ft.lbs.
Cylinder head and valves		
Cylinder head bolt	73	53
Front case and oil pump		
Oil drain plug	40	29
Oil pan bolt	7	5
Oil screen bolt	19	14
Oil relief valve plug	45	33
Front case bolt	14	11
Oil pump cover screw	10	8
Piston and connecting rod		
Connecting rod cap nut	20 + 1/4 turns	14.5 + 1/4 turns
Crankshaft, flywheel and drive plate		
Flywheel and drive plate	135	98
Rear plate bolt	11	8
Bell housing cover bolt	9	7
Oil seal case bolt	11	8
Bearing cap bolt	53	38
Oil pressure switch	19	14
Bracket		
Exhaust pipe support bracket	36	26
Engine support bracket, front	60	43
Roll stopper bracket, front	65	47
Roll stopper bracket, rear	120	87

SEALANT

Items	Specified sealant	Quantity
Thermo switch	3M Nut Locking part No. 4171 or equivalent	As required
Engine coolant temperature sensor	3M Nut Locking part No. 4171 or equivalent	As required
Engine coolant temperature gauge unit	3M ATD Part No. 8660 or equivalent	As required
Oil pan	Mitsubishi Genuine Part No. MD970389 or equivalent	As required
Oil pressure switch threads	3M ATD Part No. 8660 or equivalent	As required

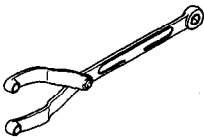
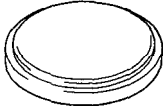
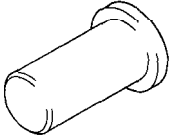
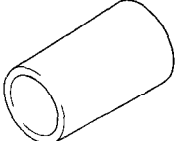
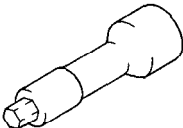
SPECIAL TOOLS

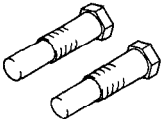
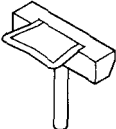
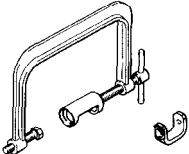
Tool	Number and tool name	Supersession	Application
	MB990767 End yoke holder Use with MD998715	MB990767-01 Use with MIT 308239	Holding camshaft sprocket when loosening or torquing bolt
	MD998011 Crankshaft rear oil seal installer	MD998011-01 Use with MB990938-01	Installation of crankshaft rear oil seal
	MD998304 Crankshaft front oil seal installer	MD998304-01	Installation of crankshaft front oil seal
	MD998305 Crankshaft front oil seal guide	MD998305-01	Installation of crankshaft front oil seal.
	MD998360 Cylinder head bolt wrench		Loosening or torquing cylinder head bolt.
	MD998713 Camshaft oil seal installer	MD998713-01	Installation of camshaft oil seal
	MD998715 Pulley holding pins (2)	MIT308239	Holding camshaft sprocket when loosening or torquing bolt
	MD998727 Oil pan remover		Removal of oil pan
	MD998735 Valve spring compressor	MD998735-01	Compression of valve spring

TSB Revision