

LIEBHERR
LF 9
 HYDRAULISCHES STEUERUNGSSYSTEM
 FÜR DIE LIEBHERR 9000
 9925001

1.1.2

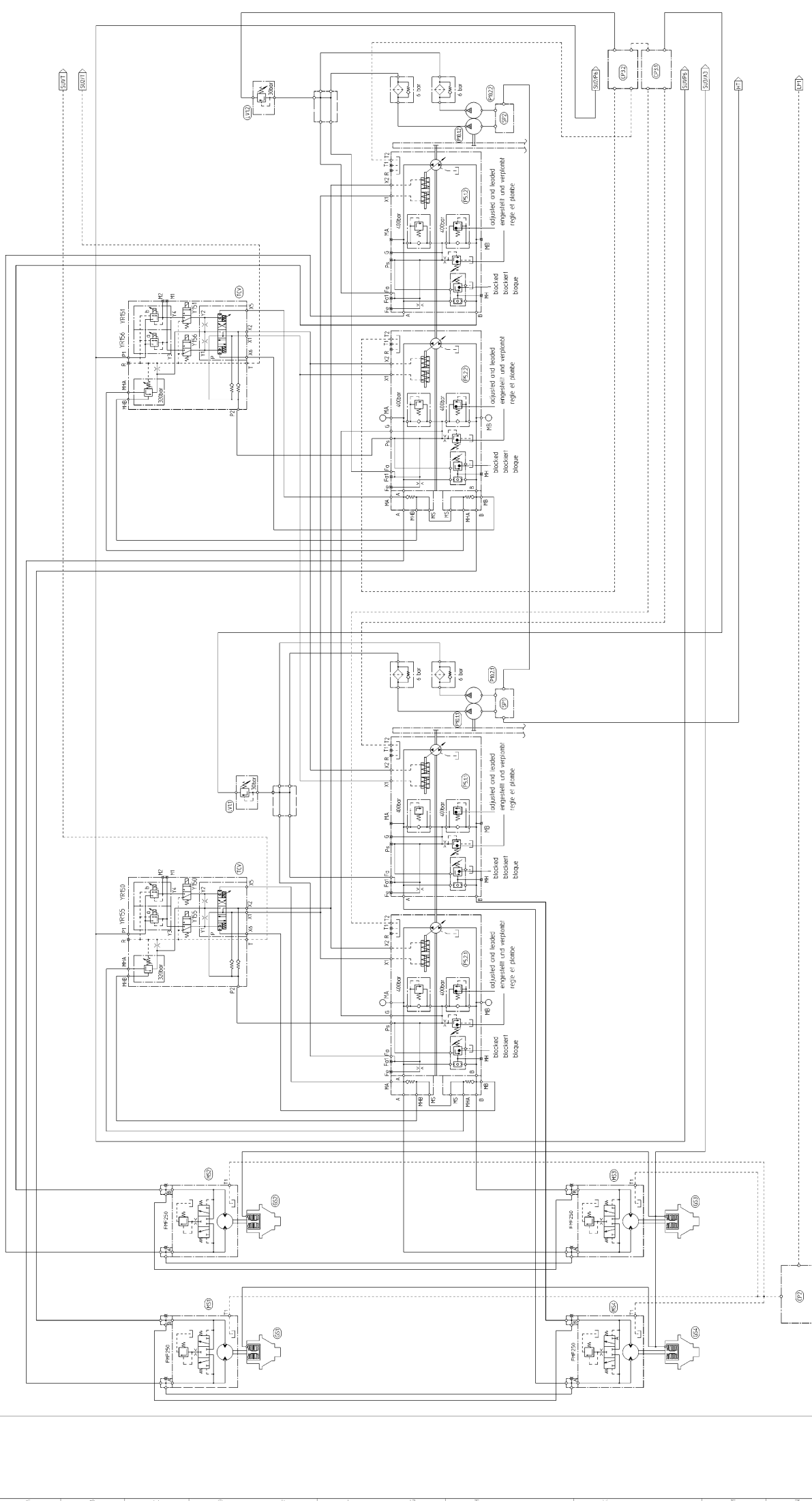

<p> LIEBHERR LFR A0 HYDRAULISCHES SCHWELFAUSSER HYDRAULIC SHOVEL ATTACHMENT SCHEMA HYDRAULIQUE </p>	<p> 02 kg 20-25°C/35 50000 L 1000000 </p>	<p> 02 kg 20-25°C/35 50000 L 1000000 </p>	<p> 02 kg 20-25°C/35 50000 L 1000000 </p>
---	--	--	--

173 7011 00 113
 9692661
 2 / 2

DREHBÜHNE
ROTATING DECK
TOURELLE

10 X SL11

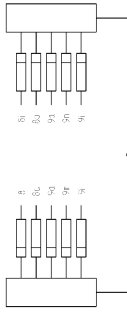

SCHWENKARM
SWIVEL ARM
FLECHE

22 X SL11

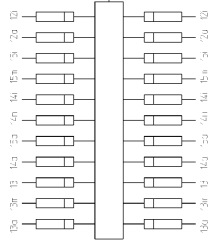

DREHRANZSCHMIERUNG
ROTATING TRACK LUBRICATION
GRAISSAGE COURONNE DE GIRATION
ENGRASE CORONA DE GIRO

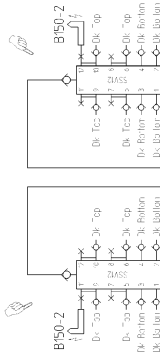
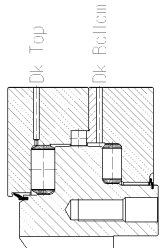

ZAHNRANZSCHMIERUNG
TOOTHED RING LUBRICATION
GRAISSAGE COURONNE

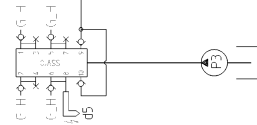
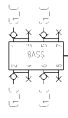

SCHAUFELSTIEL
SHOVEL POST
BALANCIER CHOULEUR

10 X SL11

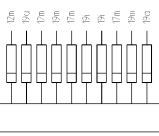

GETRIEBELAGER
GEAR BEARING
ROULEMENT REDUCTEUR

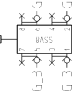

KLAPPSCHAUFEL
BUCKET
GODET CHOULEUR

22 X LMS

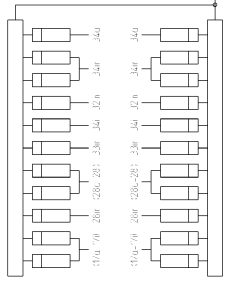

20 X SL11

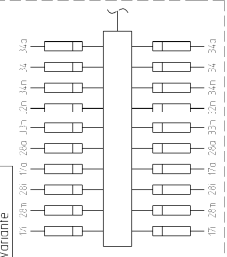

4 X LMS

ZYKLUS/CYCLE/CYCLE P1 (P2)

P1 + P2 1 W 1 - PRESSURE SW. NO. 2

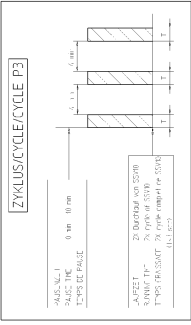
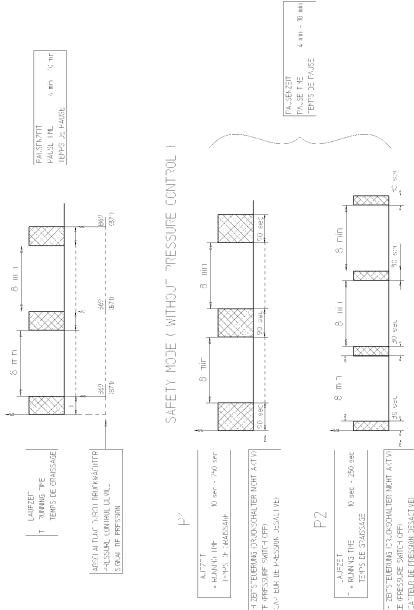

KLAPPSCHAUFELAUSRÜSTUNG
SHOVEL EQUIPMENT
EQUIPEMENT CHOULEUR

Hersteller E	LEIBERHER	Produktionsjahr	08 kg	Netto-Gewicht	0,08 kg	Bruttogewicht	0,08 kg
Produktname	KLAPPSCHAUFELAUSRÜSTUNG	Produktcode	173 1411 00 206	Produkttyp	98999/95	Produktgruppe	1 / 1

Felipeque Nº Grease pump nº Bomba de grasa nº	Zahnkranz Dienkranz Gehäuselager	Throated ring Rotating neck Gear bearing	Coronne dentee Couronne de grâlin Roulement reduit	Corona dentada Corona de giro Conejo del engranaje reductor	Punkt Point Punto	Anzahl von Schmierpunkten Number of greasing points Nombre de points de graissage Cantidad de punto	Schmiermittelpunkt Greasing point Elemente de engrase por punto	anZ/Punkt anZ/Punkt anZ/Punto	anZ/Trial anZ/Trial anZ/Trial	Umdrehungen fuer SL1 Rotation number for SL1 Nbre de tours pour le SL1 Vueltas SL1	Umdrehungen fuer SL11 Rotation number for SL11 Nbre de tours pour le SL11 Vueltas SL11	Umdrehungen fuer LPS Rotation number for LPS Nbre de tours pour le LPS Vueltas LPS
P3					B - B.C	3 4	KSSV9 - KSSV8 KSSV9 - KSSV8	0,8 0,6	37 0,6			
P2					Dk - 3p Dk - 3p Dk - 3p	3 3 3	64-55 - 2655V2 64-55 - 2655V2 64-55 - 2655V2	0,87 0,87 0,87	20 20 20			1 → 9 tm
P1	Hubzylinder / Drehbohrne Cylinder / Rotating deck cover Zylinder / Rotating deck	Hubzylinder / Drehbohrne Cylinder / Rotating deck cover Zylinder / Rotating deck	Vein de fleche / Tourelle Wip / Tourelle (cover) Wip / Tourelle	Cilindro elevador / Torallo Cilindro / Torallo (top) Cilindro / Torallo	Re / 7 Re / 7 Re / 7	2 / 2 2 2	KS-11 / KS-11 KS-11 / KS-11 KS-11 / KS-11	38 38 38	552 552 552	1 → 18,3 tm 1 → 18,3 tm 1 → 18,3 tm		
	Hubzylinder / Monobloc Zylinder / Monobloc (cover) Zylinder / Monobloc	Hubzylinder / Monobloc Cylinder / Monobloc (cover) Cylinder / Monobloc	Vein de fleche / Monobloc Wip / Monobloc (cover) Wip / Monobloc	Cilindro elevador / Monobloc Cilindro / Monobloc (top) Cilindro / Monobloc	Re / 7 Re / 7 Re / 7	2 / 2 2 2	KS-11 / KS-11 KS-11 / KS-11 KS-11 / KS-11	38 38 38	552 552 552	1 → 18,3 tm 1 → 18,3 tm 1 → 18,3 tm		
	Vorschubzylinder / Monobloc Zylinder / Monobloc (cover) Zylinder / Monobloc	Vorschubzylinder / Monobloc Cylinder / Monobloc (cover) Cylinder / Monobloc	Vein de balancier / Monobloc Wip / Monobloc (cover) Wip / Monobloc	Cilindro elevador / Monobloc Cilindro / Monobloc (top) Cilindro / Monobloc	Re / 7 Re / 7 Re / 7	2 / 2 2 2	KS-11 / KS-11 KS-11 / KS-11 KS-11 / KS-11	38 38 38	552 552 552	1 → 18,3 tm 1 → 18,3 tm 1 → 18,3 tm		
	Vorschubzylinder / Stiel Zylinder / Stiel (cover) Zylinder / Stiel	Vorschubzylinder / Stiel Cylinder / Stiel (cover) Cylinder / Stiel	Vein de balancier / Balancier Wip / Balancier (cover) Wip / Balancier	Cilindro elevador / Balancier Cilindro / Balancier (top) Cilindro / Balancier	Re / 7 Re / 7 Re / 7	2 / 2 2 2	KS-11 / KS-11 KS-11 / KS-11 KS-11 / KS-11	38 38 38	552 552 552	1 → 18,3 tm 1 → 18,3 tm 1 → 18,3 tm		
	Stiel / Monobloc Stiel / Monobloc (cover) Stiel / Monobloc	Stiel / Monobloc Stiel / Monobloc (cover) Stiel / Monobloc	Balancier / Monobloc Balancier / Monobloc (cover) Balancier / Monobloc	Balancier / Monobloc Balancier / Monobloc (cover) Balancier / Monobloc	Re / 7 Re / 7 Re / 7	2 / 2 2 2	KS-11 / KS-11 KS-11 / KS-11 KS-11 / KS-11	23 23 23	5 5 5	3 → 20,9 tm 3 → 20,9 tm 3 → 20,9 tm		
	Klappzylinder / Monobloc Zylinder / Monobloc (cover) Zylinder / Monobloc	Klappzylinder / Monobloc Cylinder / Monobloc (cover) Cylinder / Monobloc	Vein de gobeil / Monobloc Wip / Monobloc (cover) Wip / Monobloc	Cilindro elevador / Monobloc Cilindro / Monobloc (top) Cilindro / Monobloc	Re / 7 Re / 7 Re / 7	2 / 2 2 2	KS-11 / KS-11 KS-11 / KS-11 KS-11 / KS-11	38 38 38	552 552 552	1 → 18,3 tm 1 → 18,3 tm 1 → 18,3 tm		
	Drehbohrne / Monobloc Zylinder / Monobloc (cover) Zylinder / Monobloc	Drehbohrne / Monobloc Cylinder / Monobloc (cover) Cylinder / Monobloc	Tourelle / Monobloc Tourelle / Monobloc (cover) Tourelle / Monobloc	Toralle / Monobloc Toralle / Monobloc (cover) Toralle / Monobloc	Re / 7 Re / 7 Re / 7	2 / 2 2 2	KS-11 / KS-11 KS-11 / KS-11 KS-11 / KS-11	38 38 38	552 552 552	1 → 18,3 tm 1 → 18,3 tm 1 → 18,3 tm		
	Klappzylinder / Klappschaukel Zylinder / Klappschaukel (cover) Zylinder / Klappschaukel	Klappzylinder / Klappschaukel Cylinder / Klappschaukel (cover) Cylinder / Klappschaukel	Vein de gobeil / Gobeil Wip / Gobeil (cover) Wip / Gobeil	Cilindro elevador / Gobeil Cilindro / Gobeil (top) Cilindro / Gobeil	Re / 7 Re / 7 Re / 7	2 / 2 2 2	KS-11 / KS-11 KS-11 / KS-11 KS-11 / KS-11	38 38 38	552 552 552	1 → 18,3 tm 1 → 18,3 tm 1 → 18,3 tm		
	Shovel flap cylinder Shovel flap cylinder (cover) Shovel flap cylinder	Shovel flap cylinder Shovel flap cylinder (cover) Shovel flap cylinder	Vein de trappe Vein de trappe (cover) Vein de trappe	Cilindro elevador / Centre Cilindro / Centre (top) Cilindro / Centre	Re / 7 Re / 7 Re / 7	2 / 2 2 2	KS-11 / KS-11 KS-11 / KS-11 KS-11 / KS-11	38 38 38	552 552 552	1 → 18,3 tm 1 → 18,3 tm 1 → 18,3 tm		
	Klappschaukel / Stiel Klappschaukel / Stiel (cover) Klappschaukel / Stiel	Klappschaukel / Stiel Klappschaukel / Stiel (cover) Klappschaukel / Stiel	Shovel / Stiel Shovel / Stiel (cover) Shovel / Stiel	Gobeil / Balancier Gobeil / Balancier (cover) Gobeil / Balancier	Re / 7 Re / 7 Re / 7	2 / 2 2 2	KS-11 / KS-11 KS-11 / KS-11 KS-11 / KS-11	38 38 38	552 552 552	1 → 18,3 tm 1 → 18,3 tm 1 → 18,3 tm		
	Klappschaukel Klappschaukel (cover) Klappschaukel	Klappschaukel Klappschaukel (cover) Klappschaukel	Shovel Shovel (cover) Shovel	Gobeil Gobeil (cover) Gobeil	Re / 7 Re / 7 Re / 7	2 / 2 2 2	KS-11 / KS-11 KS-11 / KS-11 KS-11 / KS-11	38 38 38	552 552 552	1 → 18,3 tm 1 → 18,3 tm 1 → 18,3 tm		

P1 + P2 = 7 (h, 11) cm
P3 = 4 cm

Variante mit SL11 für die Klappschaukel Schmierung
Version with SL11 for the greasing of the shovel bucket
Variante avec SL11 pour le graissage du gobeil Chouleur

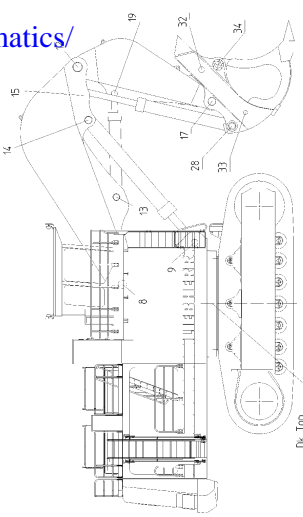

Fettanwendung
Reparation grease
Grease quantity
Reperto de grasa

G.H - Greasing Housing - Toothed ring lubrication
G.C - Greasing Centering - Swing gear centering
G.B - Greasing bearing - Swing gear bearing

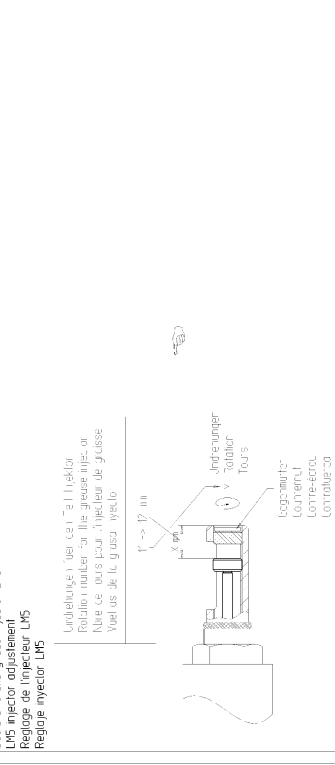
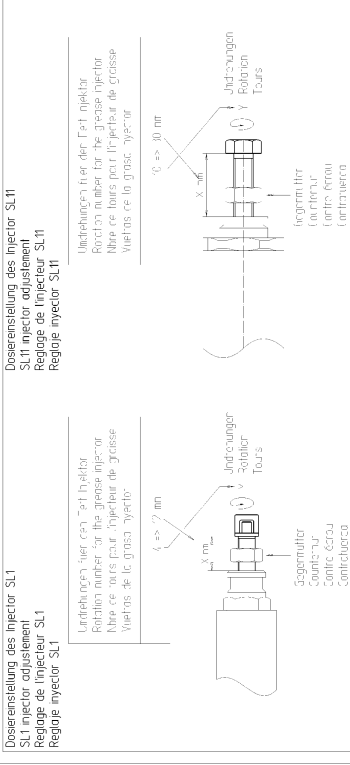
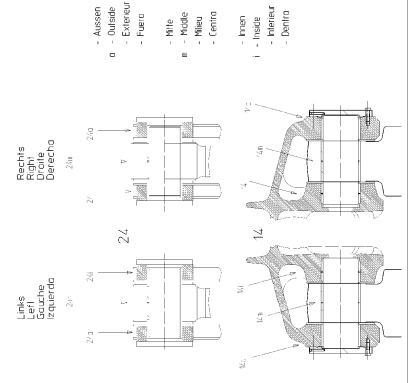

IDENTIFICAZIONE MODELLO: R996 DESCRIZIONE: GRASSATORE PER PUNTO DATA: 03/99 AUTORE:	IDENTIFICAZIONE MODELLO: R996 DESCRIZIONE: GRASSATORE PER PUNTO DATA: 03/99 AUTORE:	IDENTIFICAZIONE MODELLO: R996 DESCRIZIONE: GRASSATORE PER PUNTO DATA: 03/99 AUTORE:	IDENTIFICAZIONE MODELLO: R996 DESCRIZIONE: GRASSATORE PER PUNTO DATA: 03/99 AUTORE:
---	---	---	---

LIEBHERR
LFR A0 11

RESERVES DES DROITS DE PROPRIÉTÉ
SCHMERZETHEMEN
GREASING QUANTITIES
QUANTITIES DE GRAISSE

ETZ E-ANERKUNFT
-ASTI-ROBILIA
-ARBEIT-ROBILIA

REVISIONI INDICATIVE DEL P.O. DI REVISIONI
173 442 00 204
9894575