

OPERATOR'S MANUAL

KUBOTA EXCAVATOR

MODELS **KX** 36-2
41-2 S
41-2 V
61-2
71-2
91-2
121-2
161-2

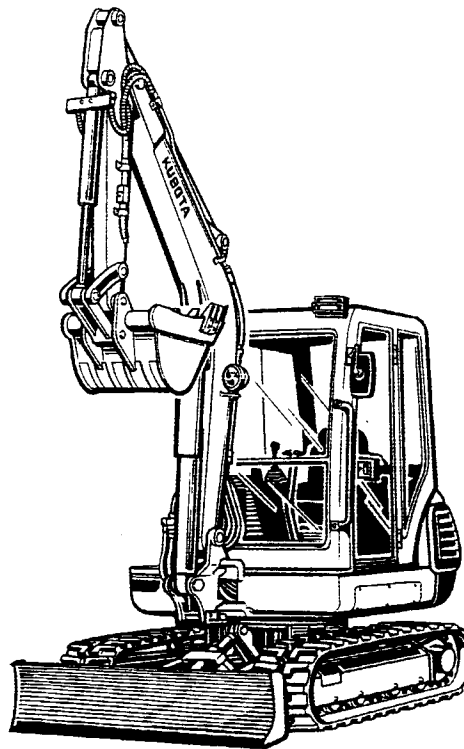

PLEASE READ THESE INSTRUCTIONS CAREFULLY
AND KEEP READY AT ALL TIMES

































Kubota

LIST OF ABBREVIATIONS

Abbreviations	Description
API	American Petrol Institut
ASTM	American Society for Testing Materials
CECE	Commitee for European Construction Machinery
DIN	German Institute for Standards - Federal Republic of Germany
EN	Europeans Standard
FOPS	Falling Object Protection System
Front	“Front” means the front view towards the boom and dozer
Hi	High Speed
ISO	International Standards Organisation
JIS	Japanese Industrial Standard
I	Volume
l/min	Volume per minute
Lo	Low Speed
MIL	Military Standards
min-1 (U/min)	min-1/Revolutions per minute
SAE	Society of Automotive Engeneering
TOPS	Tilt Over Protection System

GENERAL SYMBOLS

The instruments and operation elements have been marked with a series of symbols in order to simplify the operation of your excavator. These symbols are listed below with the respective descriptions.

- | | | | |
|---|---|---|--------------------------------------|
|  | Safety precaution symbol |  | Swing (left) |
|  | Fuel level indicator |  | Swing (right) |
|  | Coolant level |  | Dozer up |
|  | Oil pressure control lamp |  | Dozer down |
|  | Battery load status control lamp |  | Track frame extended |
|  | Glow lamp control lamp |  | Track frame sharded |
|  | Working lamp switch |  | Operation direction of control lever |
|  | Horn |  | Operation direction of control lever |
|  | Wiper/Washer switch |  | See operation manual |
|  | Diesel (Gasoil) |  | Engine stop control lamp |
|  | Hydraulic fluid | | |
|  | Gear oil | | |
|  | Grease | | |
|  | Fast | | |
|  | Slow | | |
|  | Excavator - Overhead movement towards the front | | |
|  | Excavator - Overhead movement toward the rear | | |
|  | Boom up | | |
|  | Boom down | | |
|  | Arm up | | |
|  | Arm down | | |
|  | Bucket out | | |
|  | Bucket in | | |

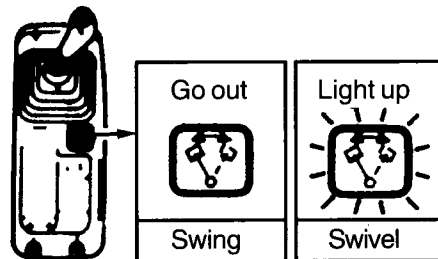

Swing / Swivel switch
Swing indicator lamp

INTRODUCTION

We congratulate you on your new KUBOTA excavator and express our deep appreciation that you have decided for our product. This excavator is a quality product of KUBOTA's engineering and production performance, manufactured with high quality materials under the strictest quality controls. With this machine you can rely on longtime satisfactory work performance. Please read the operator's manual carefully in order to attain full performance of your KUBOTA excavator. In this handbook, you will find valuable information concerning the operation and care of your machine. KUBOTA follows a policy of actualizing every progress in the product development as quickly as possible. It is possible that certain parts of this document may not be actual because of changes that have been incorporated after printing. KUBOTA's agencies and contract dealer always have the newest information at hand. Do not hesitate to contact your KUBOTA dealer.



SAFETY HAS TOP PRIORITY

You will find this safety precaution symbol before each special safety instruction in this handbook as well as on the special labels on the machine that warn of injuries due to operating errors and carelessness. Please pay careful attention to these instructions. Read these instructions and safety regulations carefully before assembly and use of your machine.



Danger : This sign warns of the possibility of a utmost dangerous situation which could lead to a serious accident if not avoided.



Warning: This sign warns to avoid dangerous situations that could lead to serious accidents.



Important: This sign calls to your attention that the respective instruction in the manual should be abided by in order to avoid damage to the excavator and attachment.



Attention: Important information

CONTENTS

IMPORTANT INFORMATION	1	TRANSPORTING THE EXCAVATOR	
DEALER SERVICE	8	ON A TRUCK	36
TECHNICAL DATA	9	LIFTING OF THE EXCAVATOR	38
LIST OF ATTACHMENTS	10	Care and Maintenance	
SWING STOPPER	13		
Operating Instructions			
		MAINTENANCE	42
DESCRIPTION OF MACHINE PARTS ...	14	MAINTENANCE INTERVALS	42
INSTRUMENT PANEL AND CONTROL		OPENING AND CLOSING OF PARTS	43
ELEMENTS	15	DAILY CHECKS	44
CHECKS BEFORE START	17	REGULAR CHECK AND	
DAILY CHECKS	17	MAINTENANCE WORK	50
CABIN TYPE MACHINES	17	EVERY 50 HOURS	50
OPERATION OF THE ENGINE	20	EVERY 200 HOURS	51
STARTING THE ENGINE	20	EVERY 250 HOURS	53
STARTING THE ENGINE		EVERY 500 HOURS	56
UNDER COLD CONDITIONS	22	EVERY 1000 HOURS	58
STOPPING THE ENGINE	22	EVERY 1000 HOURS OR	
STARTING WITH AN AUXILIARY		ONCE A YEAR	60
BATTERY	23	EVERY 2000 HOURS	60
EXCAVATOR OPERATION	24	ANNUAL SERVICING	60
RUNNING IN OF THE		BIANNUAL SERVICING	60
NEW EXCAVATOR	24	OTHER ADJUSTMENTS AND	
STARTING	24	REPLACEMENTS	63
CONTROL OBSERVATIONS DURING		PURGING OF THE FUEL SYSTEM ...	64
OPERATION	26	ADJUSTMENT OF CRAWLERS	66
DRIVING	26	EXCHANGE OF BUCKET	
URNS	28	TEETH AND SIDE CUTTERS	66
UP AND DOWNHILL DRIVING	29	FUSES	67
OPERATION OF THE DOZER	30	TROUBLESHOOTING	68
OPERATION OF TRACK FRAME	30	OPERATION OF THE EXCAVATOR	
CONTROLS FOR ATTACHMENTS	32	UNDER COLD WEATHER	
OPERATION OF BOOM	32	CONDITIONS	69
OPERATION OF ARM	32	PREPARATIONS FOR OPERATION	
OPERATION OF BUCKET	32	IN COLD WEATHER	69
SWING MOVEMENT AND SWIVEL		PROCEDURE AFTER DONE WORK .	69
MOVEMENT	32	LONG STORAGE	70
SWITCHING OF THE PRESSURE		APPENDICES	71
CONNECTIONS	33	RECOMMENDED OILS	72
SERVICE PORT OPERATION	33	LIFTING CAPACITY	73



IMPORTANT INFORMATION

The best insurance against accidents is to abide by the safety regulations.

Read the instructions carefully, before operating the excavator.

Every user, disregarding how experienced soever, should carefully read and understand these instructions and those of the attachments and accessories before taking the machine into operation.

The owner is obliged to inform the operators of these instruction in detail.

1. BEFORE OPERATION

1. Make yourself acquainted with the excavator and be aware of its limits. Read the operating instructions carefully before starting the excavator.

2. Obey all safety and warning instructions on the machine.

3. The structure of cabin is called EU TOPS-Protection.

This safty structure reduces the number of serious accidents when the excavator is tilted over.

Do not modify structual members of TOPS by welding, drilling, bending, grinding or cutting, as this may weaken the structure. If any component is damaged, replace it. Dot not attempt repairs. If TOPS is loosened or removed for any reason, make certain all parts are reinstalled correctry.

4. A seat belt is necessary with TOPS protection. The belt must be inspected regularly and replaced if damaged.

5. Never use the excavator under the influence of alcohol, medication as well as other substances. Fatigue is also dangerous.

6. Check the surroundings carefully before using the excavator or when attachments are being attached.

- Never lift loads without the safety devices on the boom and dozer cylinders.
- Pay attention to the overhead clearance to high tension wires.

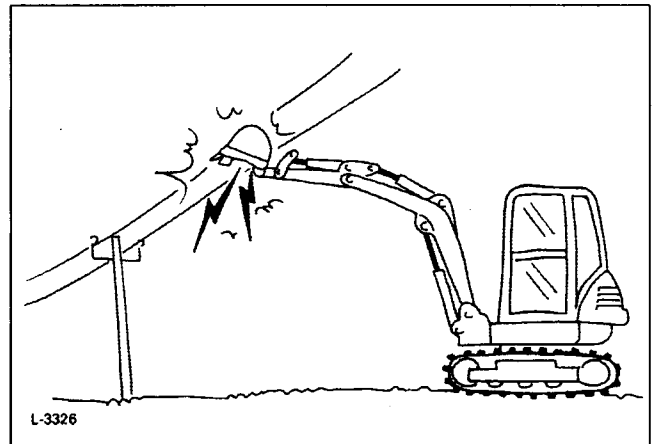

- **Check for pipes and buried cables.**
- **Check for hidden holes, hinderances and soft underground.**

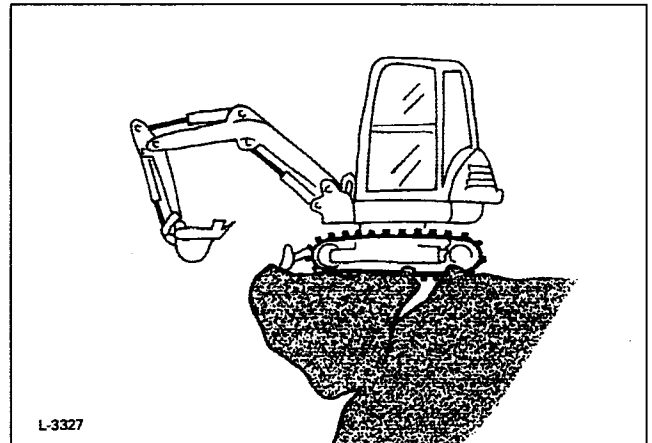

When leaving the machine, please take care to:

1. **Secure the machine against travelling away**
2. **Lower the F/A to the ground**
3. **Stop the engine**

- During excavator use do not allow any persons within the working range.
- 7. Do not allow other persons to use the machine before having informed him on the exact operation and work instructions, and be assured that the operation manual has been read in detail.
- 8. Never wear baggy, torn or too large clothing when working with the excavator. Clothing can get caught in rotating parts or control elements which can cause accidents or injuries. Wear adequate safety clothing, e.g. safety helmet, safety shoes, eye protection, ear protection, working gloves, etc., as necessary and as prescribed by law or statutes.

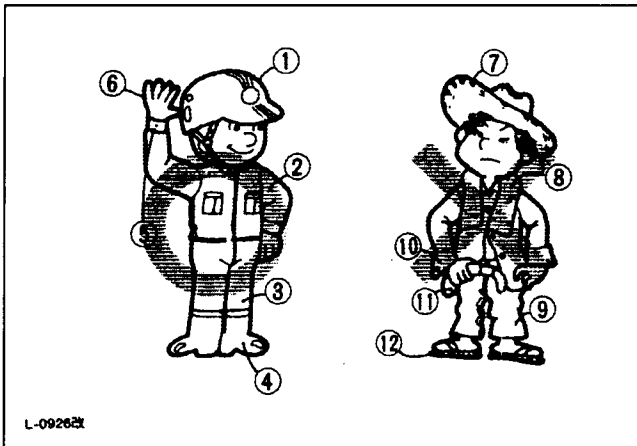

- (1) Helmet
- (2) Clothing fit for work
- (3) Tight seams
- (4) Good grip footwear
- (5) Well fitting cuffs
- (6) Working gloves
- (7) Straw hat
- (8) Towel
- (9) Baggy trousers
- (10) Loose cuffs of the shirt
- (11) Baggy shirt
- (12) Rubber sandals

- 9. It is forbidden to transport persons on inadequate seats. Co-drivers are only allowed to ride on respective correct co-drivers seats.
- 10. Check mechanical parts on correct adjustments and wear. Exchange worn or damaged parts immediately. Check nuts and bolts regularly whether tightly fit. (Details are given in the chapters MAINTENACE AND ADJUSTMENTS).

- 11. Keep your excavator clean. Heavy soiling, grease, dust and grass can inflame and cause accidents or injuries.
- 12. Use only attachments specified in the chapter „LIST OF ATTACHMENTS“ of this manual. Use only KUBOTA authorised attachments.
- 13. Before starting the excavator, be absolutely sure that the machine has been filled with fuel, lubricated, greased and undergone other maintenance work.
- 14. Do not modify the excavator, otherwise it could lead to unforeseen safety problems.

2. STARTING OF THE EXCAVATOR

- 1. Get into and out of the machine safely. Always face the machine. Always use handrails and available steps and keep yourself well balanced. Do not hold any of the controls, levers and switches. Never jump on or off the machine, whether stationary or in motion.



- 2. Start and control the excavator only from the driver's seat. The driver should never lean out of his seat when the engine is running.
- 3. Before starting the engine, make sure that all control levers (including auxillary control levers) are in their neutral positions.
- 4. Never start the motor by jumping the starter connections. Never try to circumvent using the starter switch, otherwise the engine could start suddenly and the excavator could run off.

5. Make sure that the dozer is on the front side. (The dozer must be raised).
If the levers are activated with the dozer on the rear end, the driving direction is in the opposite direction of the drive levers.

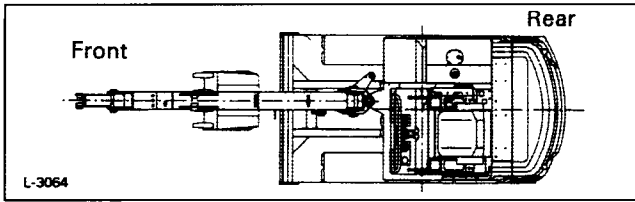

6. Never turn on the engine in closed or badly ventilated rooms. Carbon monoxide is colorless, odorless and deadly.

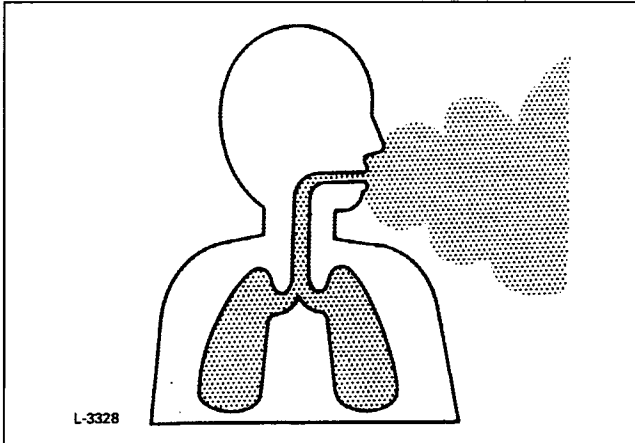

7. Keep all safety equipment and covers in place. Replace damaged or lost safety equipment.
8. Precautions against tipping over.
In order to secure safe operation, keep away from steep slopes and embankments. Never swing the bucket downwards. Lower the dozer during digging. Keep the bucket as low as possible while driving upwards. Turn slowly on slopes (never fast). Never keep the excavator near the edges of trenches and banks, as the earth can give away due to the weight of the excavator.

ALLOWABLE CLIMBING ANGLE

KX36-2, 41-2S, 41-2V	27% (15deg.)
KX61-2, 71-2, 91-2, 121-2, 161-2	36% (20deg.)

ALLOWABLE ANGLE IN CASE OF CROSSING SIDEWAYS

KX36-2, 41-2S	18% (10deg.)
KX41-2V / track shorten	
KX61-2, 71-2, 91-2, 121-2, 161-2	27% (15deg.)
KX41-2V / track extended	

9. Watch out at all times where the excavator is being moved to. Keep an eye out for hinderances.
10. Keep enough distance from trench and bank edges

3. AFTER OPERATION

Before leaving the machine,

- Bring the machine on a hard even ground
- Lower the attachments and the dozer blade on the ground
- Stop the engine.
- Lock all control levers.
- Remove the key.

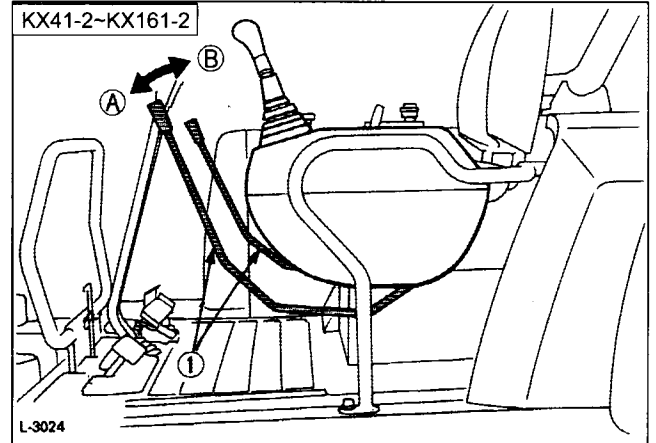
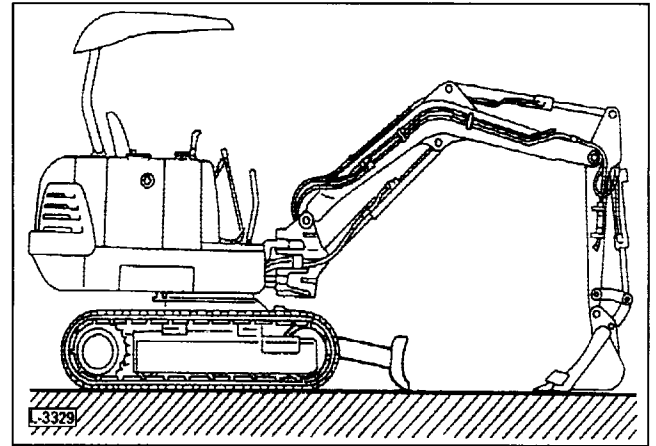

(1) Lock lever for control lever

(A) Unlocked
(B) Locked

[KX 36-2]

When getting into or out from the left side, lift the left lock lever all the way up to lock left control lever.

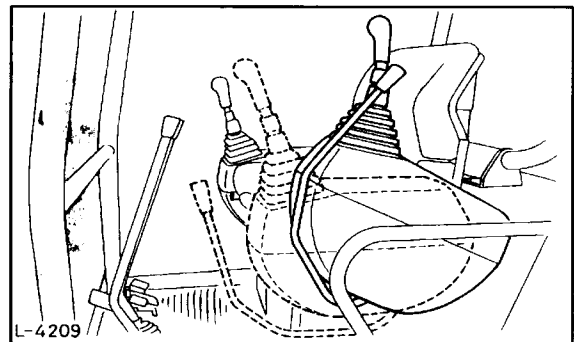

When getting into or out from the right side, lift the right lock lever all the way up to lock right control lever.

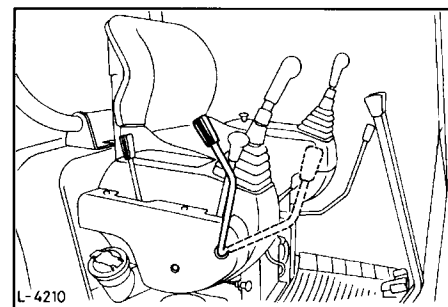

Note: To lock both control levers (right/left), both lock levers must be in the up position. Both control levers (arm, swivel, boom, bucket) of the KX41-2 to KX 161-2 are locked when one lock lever (left or right) is in the up position.

4. SAFE LOADING AND TRANSPORT OF THE EXCAVATOR

1. Observe all regulations concerning the transport of excavators on public roads.
2. Use adequately long and robust ramps when loading on a truck. (for details see the chapter on loading and transporting).
3. Never change the running direction and to avoid a tipping over, do not try to swing the attachment cross-wise to the loading ramps.
4. After loading of the excavator on a truck, engage the swing lock pin.

Lower the attachment on the loading plane and release the pressure from the hydraulic system. Block the crawlers with blocks and wire down the excavator. After loading the excavator on a truck, tie down the undercarriage of the machine with a strong steel wire on the truck.

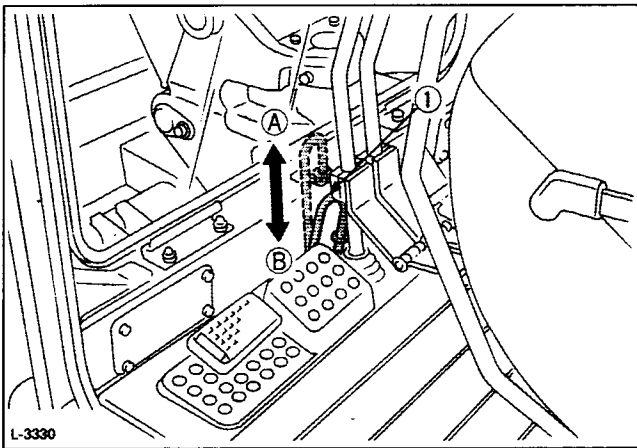

(1) Swivel lock (A) Unlocked
(B) Locked

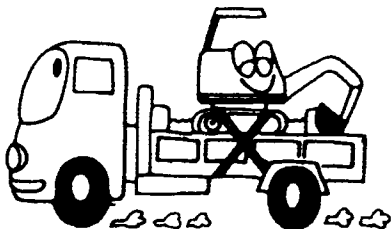

L-0925

5. Never brake abruptly with the excavator loaded. Mortal accidents could happen.
6. If the excavator is to tow another machine, the weight of the towed machine must be smaller than the strength of the hook.

	KX36-2 KX41-2S,V	KX61-2, 71-2, KX91-2, 121-2	KX161-2
Max. drawbar pull at cuppling hook (N)	32270	70540	94715
Max. vertical load at cuppling hook (N)	2660	7210	7210

5. MAINTENANCE

Before doing maintenance work on the excavator, place the machine on an even solid underground, lower the attachments on the

ground, stop the engine and release the cylinder pressure by actuating the levers.

When dismanteling hydraulic parts, make sure that the hydraulic oil has cooled down sufficiently to avoid burns.

Start maintenance work carefully, e.g. loosen screws slowly so that oil will not squirt out.

1. Before doing work on the engine, the exhaust system, the radiator and the hydraulics, let the excavator cool down sufficiently.
2. Turn off the engine at all times when filling with fuel. Avoid spilling and over-filling of fuel.
3. Smoking is prohibited while tanking and handling the battery! Keep sparks and fire away from the fuel tank and battery. Flammable gases escape from the battery, especially during charging.
4. Read and follow the directions in the chapter „Starting with an auxillary battery“ in the instructions „Operation of the Engine“, when starting with an auxillary battery.
5. Keep a first-aid box and a fire extinguisher at hand at all times.
6. Never open the radiator cap before the radiator has cooled down sufficiently.
First turn the cap loose up to the first stop and allow the system enough time to release the remaining pressure. Then loosen the cap completely.
7. To avoid shortcircuiting the battery, always remove the earth cable first and attach the plus cable first.
8. Leaking hydraulic fluid has enough pressure to penetrate the skin and cause serious injuries. Leakages from pin holes can be totally invisible. Never use the bare hand for checking on possible leakages. Always use a piece of wood or cardboard. It is strongly recommended to use a face mask or eye protection.
Should injuries occur with leaking hydraulic fluid, contact a doctor immediately. This fluid can cause gangrene or serious allergic reactions.

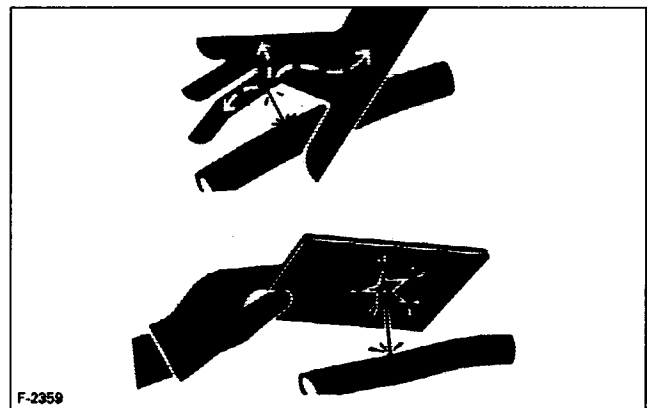

F-2359

9. [Except KX36-2] The pressure reservoir is filled with gas under high pressure. Never discard the reservoir before releasing pressure. To avoid explosions, never weld or cut open the pressure reservoir, or throw into open fire.

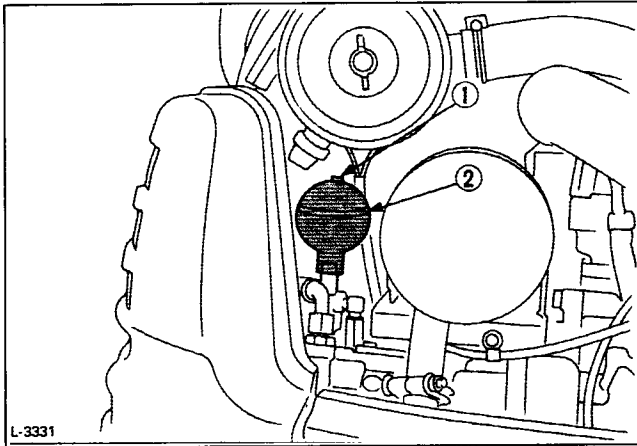

(1) Plug
(2) Pressure reservoir

10. To avoid leakage of battery acid which contains heavy metals, never throw the battery away.
11. Observe all laws and regulations concerning the disposal of used oil, coolants, solvents, hydraulic fluids, battery acids and batteries.
12. To avoid fire, never heat the hydraulic components (tanks, pipes, hoses, cylinders) before they have been drained and washed.
13. Use a face mask or eye protection to protect the eyes and respiratory system against dust and other foreign particles.

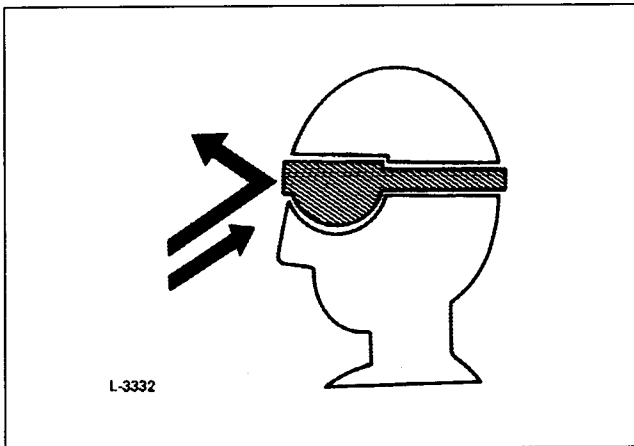

L-3332

only supported by the boom and arm or the dozer. The excavator can tip over or lower itself due to hydraulic pressure loss. Always use safety struts or other appropriate supports.

15. Do not dismantle the spring of the crawler tensioner. If dismantling is necessary, contact your sales company where the machine was purchased, or a service shop.

The assembly must be done according to the service shop handbook of KUBOTA (W.S.M.).

16. KUBOTA uses no parts which are lined with asbest. Never use these kind of parts even if they can be installed.

17. (Only for KX41-2V)

Attention for track operation

- To avoid any accidents or misoperation, the track / dozer change lever should be switched completely to the end

- The track with should be used with maximum 1300 mm or minimum 1000 mm.

If you use this track within the ends, your machine cannot be fixed on one position and became unstable situation.