

Shop Manual

VEBM250100



WA65-5

WA70-5

WA80-5

WHEEL LOADER

MODEL:

WA65-5

WA70-5

WA80-5

SERIAL NUMBER:

H50051 AND UP

H50051 AND UP

H50051 AND UP

- This shop manual may contain attachments and optional equipment that are not available in your area. Please consult your local KOMATSU distributor for those items you may require. Materials and specifications are subject to change without notice.
- The Wheel Loaders WA65-5, WA70-5 and WA80-5 are equipped with the engine 4D95LE-3. For details of this engine see Engine Manual, P/N CU3666417-00.

CONTENTS

	No. of page
00 SAFETY	00-1
01 GENERAL	01-1
10 STRUCTURE AND FUNCTION	10-1
20 TESTING AND ADJUSTING	20-1
30 DISASSEMBLY AND ASSEMBLY	30-1
90 OTHERS.....	90-1

00 SAFETY

Safety notice	00-3
Preparations for work	00-4
Tipping up the driver's cab	00-4
Tipping down the driver's cab	00-7
Precautions during work	00-8
Foreword	00-11
How to read the shop manual	00-12
Volumes	00-12
Distribution and updating	00-12
Filing method	00-12
Symbols	00-13
Hoisting instructions	00-14
Wire ropes	00-14

Safety notice



Important Safety Notice

Proper service and repair is extremely important for safe machine operation. Some of the described service and repair techniques require the use of tools specially designed by Komatsu for the specific purpose.

To prevent injury to workers, the symbol  is used to mark safety precautions in this manual. The cautions accompanying these symbols must always be followed carefully. If any dangerous situation arises or may possibly arise, first consider safety, and take the necessary actions to deal with the situation.



General Precautions

Mistakes in operation are extremely dangerous. Read the **OPERATION AND MAINTENANCE MANUAL** carefully before operating the machine! Always follow the safety rules valid in your country carefully!

1. Before carrying out any greasing or repairs, read all the precautions given on the decals which are fixed to the machine.
2. When carrying out any operation, always wear safety shoes and helmet. Do not wear loose work clothes, or clothes with buttons missing.
 - Always wear safety glasses when hitting parts with a hammer.
 - Always wear safety glasses when grinding parts with a grinder, etc.
3. If welding repairs are needed, always have a trained, experienced welder carry out the work. When carrying out welding work, always wear welding gloves, apron, glasses, cap and other clothes suited for welding work.
4. When carrying out any operation with two or more workers, always agree on the operating procedure before starting. Always inform your fellow workers before starting any step of the operation. Before starting work, hang UNDER REPAIR signs on the controls in the operator's compartment.

5. Keep all tools in good condition and learn the correct way to use them.
6. Decide a place in the repair workshop to keep tools and removed parts. Always keep the tools and parts in their correct places. Always keep the work area clean and make sure that there is no dirt or oil on the floor. Never smoke while working. Smoke only in the areas provided for smoking.

Preparations for work

1. Before adding oil or making any repairs, park the machine on hard, level ground, and block the wheels or tracks to prevent the machine from moving.
2. Before starting work, lower blade, ripper, bucket or any other work equipment to the ground and install the safety bar on the frame. If this is not possible, insert the safety pin or use blocks to prevent the work equipment from falling. In addition, be sure to lock all the control levers and hang warning signs on them.
3. When disassembling or assembling, support the machine with blocks, jacks or stands before starting work.
4. Remove all mud and oil from the steps or other places used to get on and off the machine. Always use the handrails, ladders or steps when getting on or off the machine. Never jump on or off the machine. If it is impossible to use the handrails, ladders or steps, use a stand to provide safe footing.

Tipping up the driver's cab

1. Park the machine on solid, level ground.
2. Lower the work unit to the ground and switch off the engine.
3. Use the locking bolt to secure the articulated steering (cross-reference "Securing the articulated steering", Page 2-24).

The machine has to be positioned straight and the articulated steering has to be secured with the locking bolt! If the driver's cab is tipped up while the machine is bent, the front frame can cause damage to the windscreen!

4. Open the bonnet..

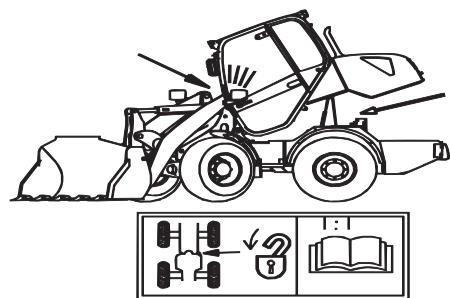

G0065099

5. Remove the cab fastening screws under the rear wheel cover (arrow).

2 screws on the left and 2 screws on the right (1).

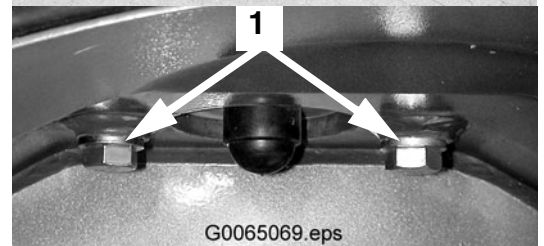

6. Take the hand pump lever out of its holder on the radiator (2) and insert it into the receptacle of the pump (3).

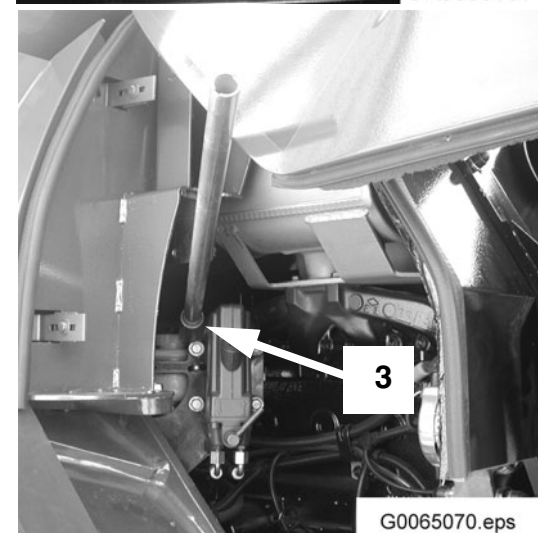
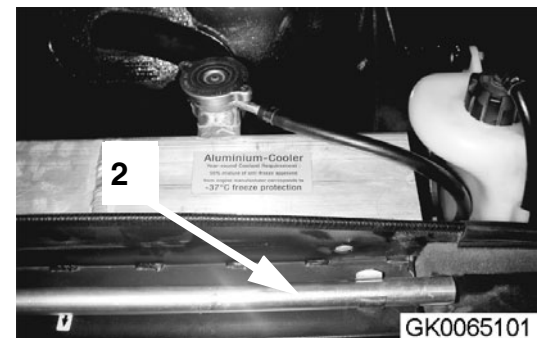

7. Set the lever at the pump to "pump up" and pump the cab upward until it reaches the limit stop.

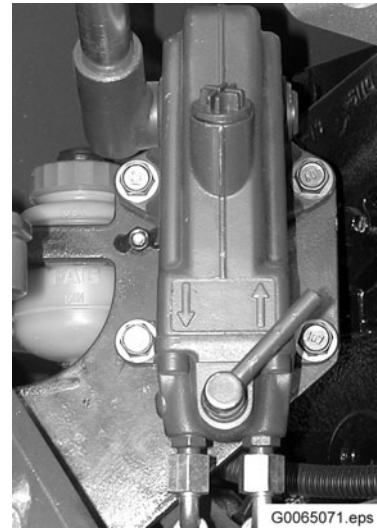

8. Move the safety rod on the right side upward until it reaches the pin at the cab floor.



9. Set the lever at the pump to "pump down" and pump the cab downward until the safety rod is secure against the right side of the cab floor.



10. Take the lever out of the pump.

Tipping down the driver's cab

1. Insert the lever into the pump. Set the lever at the pump to "pump up" and pump the cab upward until it reaches the limit stop.

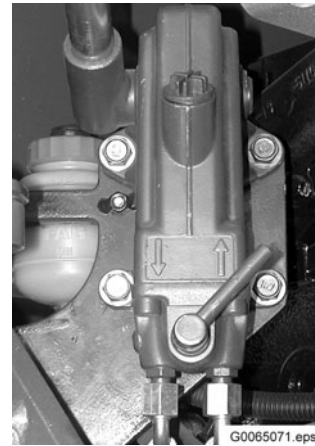

2. Fold down the safety rod on the right side and fasten it in this position (arrow).

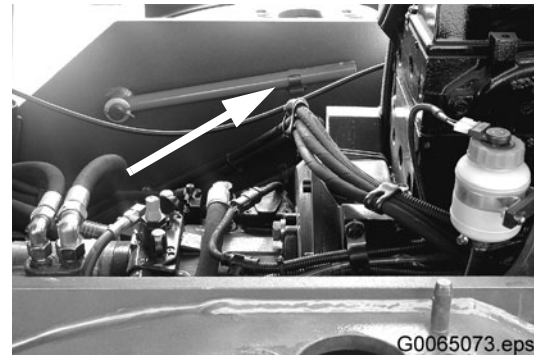

3. Set the lever to "pump down" and pump the cab downward until the cylinder is entirely retracted (the resistance at the lever increases markedly).

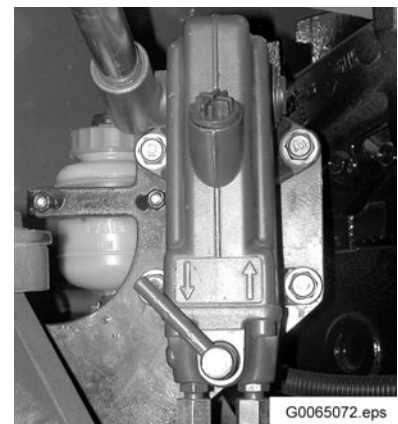

NOTE

Make sure that the guide pin (arrow) on the left of the rear frame is inserted into the guide bushing of the cab.



4. Screw in the fastening screws for the cab (2 left, 2 right) and tighten the screws.

Torque = 230 Nm.

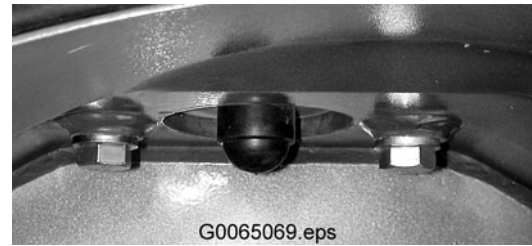

5. Remove the lever from the pump and fasten it to the radiator.

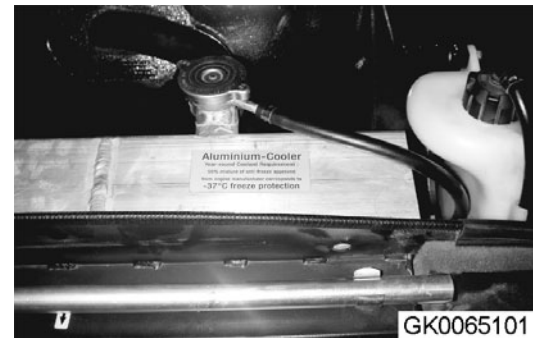

6. Close the bonnet.

Precautions during work

1. When measuring hydraulic pressure, check that the measuring tool is correctly assembled before taking any measurements.
2. When removing the oil filler cap, drain plug or hydraulic pressure measuring plugs, loosen them slowly to prevent the oil from spurting out.
Before disconnecting or removing components of the oil, water or air circuits, first remove the pressure completely from the circuit.
3. The water and oil in the circuits are hot when the engine is stopped, so be careful not to get burned.
Wait for the oil and water to cool before carrying out any work on the oil or water circuits.
4. Before starting work, remove the leads from the battery. Always remove the lead from the negative (-) terminal first.
5. When raising heavy components, use a hoist or crane.
Check that the wire rope, chains and hooks are free from damage.
Always use lifting equipment which has ample capacity.
Install the lifting equipment at the correct places. Use a hoist or crane and operate slowly to prevent the component from hitting any other part.
Do not work with any part still raised by the hoist or crane.
6. When removing covers which are under internal pressure or

under pressure from a spring, always leave two bolts in position on opposite sides. Slowly release the pressure, then slowly loosen the bolts to remove.

7. When removing components, be careful not to break or damage the wiring. Damaged wiring may cause electrical fires.
8. When removing piping, stop the fuel or oil from spilling out. If any fuel or oil drips onto the floor, wipe it up immediately. Fuel or oil on the floor can cause you to slip, or can even start fires.
9. As a general rule, do not use gasoline to wash parts. In particular, use only the minimum of gasoline when washing electrical parts. Do not smoke!
10. Be sure to assemble all parts again in their original places.

Replace any damaged parts with new parts.

When installing hoses and wires, be sure that they will not be damaged by contact with other parts when the machine is being operated.

11. When installing high pressure hoses, make sure that they are not twisted.

Damaged tubes are dangerous, so be extremely careful when installing tubes for high pressure circuits. Also, check that connecting parts are correctly installed.

12. When aligning two holes, never insert your fingers or hand. Be careful not to get your fingers caught in a hole.
13. When assembling or installing parts, always use the specified tightening torques. When installing protective parts such as guards, or parts which vibrate violently or rotate at high speed, be particularly careful to check that they are installed correctly.

Foreword

General

This shop manual has been prepared as an aid to improve the quality of repairs by giving the service personnel an accurate understanding of the product and by showing them the correct way to perform repairs and make judgements. Make sure you understand the contents of this manual and use it to full effect at every opportunity.

This shop manual mainly contains the necessary technical information for operations performed in a service workshop. For ease of understanding, the manual is divided into the following chapters; these chapters are further divided into the each main group of components:

Structure and function

This section explains the structure and function of each component. It serves not only to give an understanding of the structure, but also serves as reference material for troubleshooting.

Testing and adjusting

This section explains checks to be made before and after performing repairs, as well as adjustments to be made at completion of the checks and repairs. Troubleshooting charts correlating "Problems" to "Causes" are also included in this section.

Disassembly and assembly

This section explains the order to be followed when removing, installing, disassembling or assembling each component, as well as precautions to be taken for these operations.

Maintenance standard

This section gives the judgement standards when inspecting disassembled parts.

NOTE

The specifications contained in this shop manual are subject to change at any time and without any advance notice. Use the specifications given in the book with the latest date.

How to read the shop manual

Volumes

Shop manuals are issued as a guide to carrying out repairs.

Distribution and updating

Any additions, amendments or other changes will be sent to Komatsu distributors.

Get the most up-to-date information before you start any work.

Filing method

1. See the page number on the bottom of the page. File the pages in correct order.
2. Following examples show how to read the page number.

Example 1 (Chassis volume):

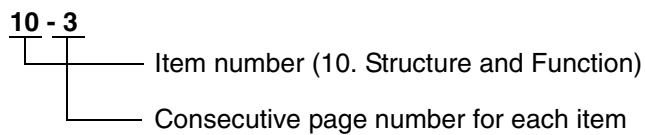





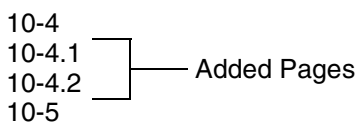

3. Additional pages: Additional pages are indicated by a point (.) and number after the page number. File as in the example.

Example:



Symbols

So that the shop manual can be of ample practical use, important safety and quality portions are marked with the following symbols:

Symbol	Item	Remarks
	Safety	Special safety precautions are necessary when performing the work.
	Caution	Special technical precautions or other precautions for preserving standards are necessary when performing the work.
	Weight	Weight of parts of systems. Caution necessary when selecting hoisting wire, or when working posture is important, etc.
	Tightening torque	Places that require special attention for the tightening torque during assembly.
	Coat	Places to be coated with adhesives and lubricants, etc.
	Oil, water	Places where oil, water or fuel must be added, and the capacity.
	Drain	Places where oil or water must be drained, and quantity to be drained.

Hoisting instructions



Heavy parts (25kg or more) must be lifted with a hoist, etc. In the DISASSEMBLY AND ASSEMBLY section, every part weighing 25 kg or more is indicated clearly with the symbol:



If a part cannot be smoothly removed from the machine by hoisting, the following checks should be made:

1. Check for removal of all bolts fastening the part to the relative parts.
2. Check for existence of another part causing interference with the part to be removed.

Wire ropes

1. Use adequate ropes depending on the weight of parts to be hoisted, referring to the table below:
 - The allowable load in tons, is given by vertical tensible force.
 - The allowable load value is estimated to be one-sixth or one-seventh of the breaking strength of the rope used.

Wire ropes: (Standard "Z" or "S" twist ropes without galvanizing)	
Rope diameter (mm)	Allowable load (tons)
10	1.0
11.2	1.4
12.5	1.6
14	2.2
16	2.8
18	3.6
20	4.4
22.4	5.6
30	10.0
40	18.0
50	28.0
60	40.0

2. Sling wire ropes from the middle portion of the hook.

Slinging near the edge of the hook may cause the rope to slip off the hook during hoisting, and a serious accident can result. Hooks have maximum strength at the middle portion.

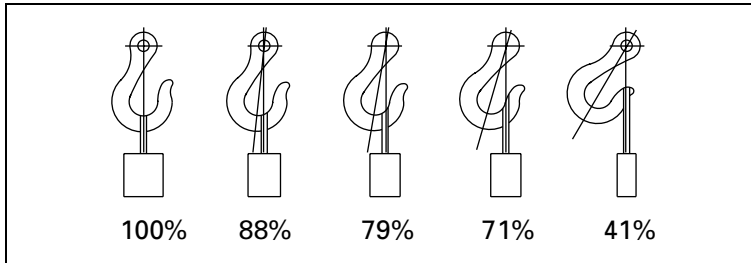

3. Do not sling a heavy load with one rope alone, but sling with two or more ropes symmetrically wound onto the load.



Slinging with one rope may cause turning of the load during hoisting, untwisting of the rope, or slipping of the rope from its original winding position on the load, which can result in a dangerous accident.

4. Do not sling a heavy load with ropes forming a wide hanging angle from the hook.

When hoisting a load with two or more ropes, the force subjected to each rope will increase with the hanging angles.

The table below shows the variation of allowable load (kg) when hoisting is made with two ropes, each of which is allowed to sling up to 1000 kg vertically, at various hanging angles.

When two ropes sling a load vertically, up to 2000 kg of total weight can be suspended. This weight becomes 1000 kg when two ropes make a 120° hanging angle. On the other hand, two ropes are subjected to an excessive force as large as 4000 kg if they sling a 2000 kg load at a lifting angle of 150°.

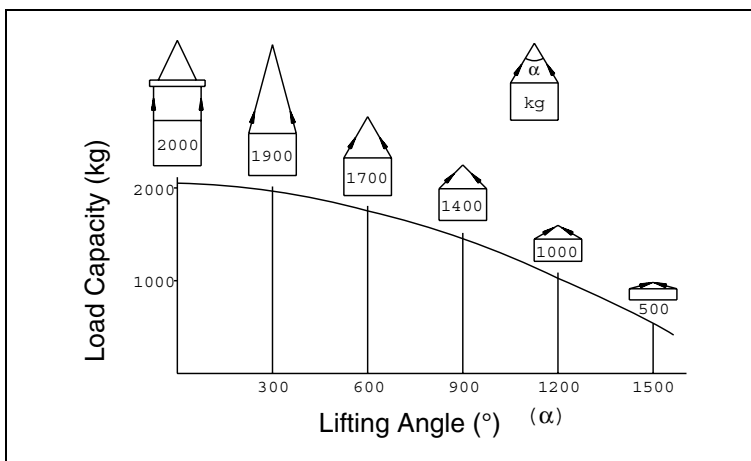

01 GENERAL

Dimensions, weights and operating data WA65-5	01-3
Specifications WA65-5	01-4
Weight table WA65-5	01-5
Dimensions, weights and operating data WA70-5	01-6
Specifications WA70-5	01-7
Weight table WA70-5	01-8
Dimensions, weights and operating data WA80-5	01-9
Specifications WA80-5	01-10
Weight table WA80-5	01-11
Lubricants and operating mediums: WA65-5/ WA70-5	01-12
Lubricants and operating mediums: WA80-5	01-13
Basic procedures of maintenance	01-14
Oil	01-14
Fuel	01-14
Coolant	01-15
Grease	01-15
Storing oil and fuel	01-15
Filters	01-16
Biodegradable hydraulic oils and lubricants	01-16
Outline of electric system	01-16
Torque list – screws and nuts	01-17

Blank for technical reason