

Operation & Maintenance Manual

PC340-6K

PC340LC-6K

PC340NLC-6K

HYDRAULIC EXCAVATOR

SERIAL NUMBERS	PC340-6K	- K30001	
	PC340LC-6K	- K30001	AND UP
	PC340NLC-6K	- K30001	



— WARNING —

Unsafe use of this machine may cause serious injury or death. Operators and maintenance personnel must read this manual before operating or maintaining this machine. This manual should be kept inside the cab for reference and periodically reviewed by all personnel who will come into contact with the machine.

KOMATSU

1. FOREWORD

This manual provides rules and guidelines which will help you use this machine safely and effectively. Keep this manual handy and have all personnel read it periodically. If this manual has been lost or has become dirty and can not be read, request a replacement manual from Komatsu or your Komatsu distributor.

If you sell the machine, be sure to give this manual to the new owners.

Continuing improvements in the design of this machine can lead to changes in detail which may not be reflected in this manual. Consult Komatsu or your Komatsu distributor for the latest available information for your machine or for questions regarding information in this manual.

WARNING

- **This operation & maintenance manual may contain attachments and optional equipment that are not available in your area. Please consult your local Komatsu distributor for those items you require.**
- **This machine complies with EC directive (89/392/EEC).
Machines complying with this directive display the CE mark**
- **Improper operation and maintenance of this machine can be hazardous and could result in serious injury or death.**
- **Operators and maintenance personnel should read this manual thoroughly before beginning operation or maintenance.**
- **Some actions involved in operation and maintenance of the machine can cause a serious accident, if they are not done in a manner described in this manual.**
- **The procedures and precautions given in this manual apply only to intended uses of the machine. If you use your machine for any unintended uses that are not specifically prohibited, you must be sure that it is safe for you and others. In no event should you or others engage in prohibited uses or actions as described in this manual.**
- **Komatsu delivers machines that comply with all applicable regulations and standards of the country to which it has been shipped. If this machine has been purchased in another country or purchased from someone in another country, it may lack certain safety devices and specifications that are necessary for use in your country. If there is any question about whether your product complies with the applicable standards and regulations of your country, consult Komatsu or your Komatsu distributor before operating the machine.**
- **The description of safety is given in SAFETY INFORMATION on page 0-2 and in SAFETY from page 1-1.**

2. SAFETY INFORMATION

2.1 SAFETY MESSAGES

Most accidents are caused by the failure to follow fundamental safety rules for the operation and maintenance of machines.

To avoid accidents, read, understand and follow all precautions and warnings in this manual and on the machine before performing operation and maintenance.

To identify hazards on the machine pictorial decals are used (see POSITION FOR ATTACHING SAFETY LABELS).

-  **RED WARNING TRIANGLE** - This is used on safety labels where there is a high probability of serious injury or death if the hazard is not avoided. These safety messages or labels usually describe precautions that must be taken to avoid the hazard. Failure to avoid this hazard may also result in serious damage to the machine.

-  **ORANGE WARNING TRIANGLE** - This is used on safety labels where there is a potentially dangerous situation which could result in serious injury or death if the hazard is not avoided. These safety messages or labels usually describe precautions that must be taken to avoid the hazard. Failure to avoid this hazard may also result in serious damage of the machine

-  **YELLOW SAFETY TRIANGLE** - This is used on safety labels for hazards which could result in minor or moderate injury if the hazard is not avoided. This word might also be used for a hazard where the only result could be damage to the machine.

- NOTICE** - This word is used for precautions that must be taken to avoid actions which could shorten the life of the machine.

Safety precautions are described in SAFETY from page 1-1.

Komatsu cannot predict every circumstance that might involve a potential hazard in operation and maintenance. Therefore the safety message in this manual and on the machine may not include all possible safety precautions. If any procedures or actions not specifically recommended or allowed in this manual are used, you must be sure that you and others can do such procedures and actions safely and without damaging the machine. If you are unsure about the safety of some procedures, contact Komatsu or your Komatsu distributor.

2.2. NOISE

Operator ears noise value
(Sound pressure level)



Ambient noise value
(Sound power level)



Noise level indicated is the guaranteed value as specified in the directive 86/662/EEC

2.3. VIBRATION

- The weighted root mean square acceleration value to which the operator's arms are subjected does not exceed 2.5 m/s
- The weighted root mean square acceleration value to which the operator's body is subjected does not exceed 0.5 m/s

These results were obtained by accelerometers during trench digging.

3. INTRODUCTION

3.1 INTENDED USE

This Komatsu HYDRAULIC EXCAVATOR is designed to be used mainly for the following work:

- Digging
- Smoothing work
- Ditching work
- Loading work

See the section 12.14 "WORK POSSIBLE USING HYDRAULIC EXCAVATOR" for further details

3.2 FEATURES

- This Komatsu HYDRAULIC EXCAVATOR is equipped with various controls based on an advanced electronics system.
- The monitor panel greatly facilitates daily maintenance and self-diagnosis.
- Working mode, travel speed and swing priority are selectable.
- Digging and lifting force can be increased by light-touch control. (For details, see operation section.)
- Adjustable wrist control levers make operations smooth and easy.
- Fresh filtered air heater assures comfortable operation. (Air conditioner option)
- Low noise level and smart urban style design and colouring.
- Superb operation performance provided by powerful engine and high-performance hydraulic pumps.
- Low fuel consumption controlled by an electronic control system provides an environment-friendly machine.

3.3 BREAKING IN YOUR NEW MACHINE

Your Komatsu machine has been thoroughly adjusted and tested before shipment.

However, operating the machine under severe conditions at the beginning can adversely affect the performance and shorten the machine life.

Be sure to break in the machine for the initial 100 hours (as indicated by the hour meter.)

During breaking in:

- Idle the engine for 5 minutes after starting it up.
- Avoid operation with heavy loads or at high speeds.
- Sudden starting or acceleration, unnecessarily abrupt braking and sharp turning should be avoided except in cases of emergency.

Additionally for the first 20 hours

- Avoid operating engine for prolonged periods at constant speed (including idle.)
- Avoid high speed travelling for periods of more than 5 minutes.

Pay particular attention to oil pressure and temperature indicators & check coolant and oil levels frequently during breaking in.

The precautions given in this manual for operating, maintenance, and safety procedures are only those that apply when this product is used for the specified purpose. If the machine is used for a purpose that is not listed in this manual, Komatsu cannot bear any responsibility for safety. All consideration of safety in such operations is the responsibility of the user.

Operations that are prohibited in this manual must never be carried out under any circumstances.

4. LOCATION OF PLATES, TABLE TO ENTER SERIAL NO. AND DISTRIBUTOR

4.1 MACHINE SERIAL NO. PLATE POSITION

On the front bottom right of the operator's cab

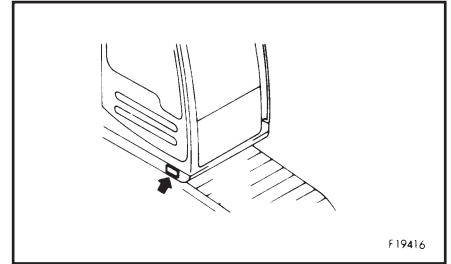

4.2 ENGINE SERIAL NO. PLATE POSITION

On the gear case front corner.

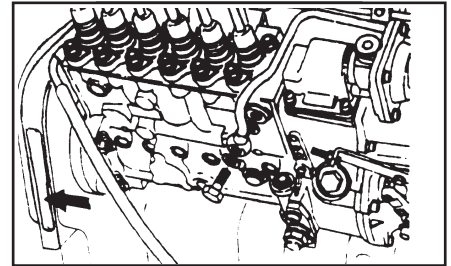

4.3 TABLE TO ENTER SERIAL NO. AND DISTRIBUTOR

Machine serial No.:	
Engine serial No.:	
Manufactureres name: Komatsu UK Ltd	
Address	Durham Road Birtley Chester-Le-Street County Durham DH32QX United Kingdom
Distributor	
Address	Phone

4.4 MACHINE SERIAL PLATE.

CE	MODEL	<input type="text"/>
	SERIAL No	<input type="text"/>
		<input type="text"/>
	WEIGHT	<input type="text"/>
	ENGINE POWER	<input type="text"/>
	MANUFACTURER	
Produced by Komatsu UK Ltd. for Komatsu Ltd, Tokyo, Japan.		

5. CONTENTS

1. Foreword	0-1
2. Safety information	0-2
3. Introduction	0-4
4. Location of plates, table to enter serial No. and distributor	0-5

SAFETY

6. General Precautions	1-2
7. Precautions during operation	1-8
7.1 Before starting engine	1-8
7.2 Operating machine	1-10
7.3 Transportation	1-15
7.4 Battery	1-16
7.5 Towing	1-17
7.6 Bucket with hook	1-18
8. Precautions for maintenance	1-21
8.1 Before carrying out maintenance	1-21
8.2 During maintenance	1-24
9. Position for attaching safety labels	1-28

OPERATION

10. General view	
10.1 General view of machine	2-2
10.2 General view of controls and gauges	2-3
11. Explanation of components	
11.1 Machine monitor	2-4
11.2 Switches	2-15
11.3 Control levers, pedals	2-19
11.4 Roof hatch	2-24
11.5 Front window	2-25
11.6 Door lock	2-27
11.7 Cap, cover with lock	2-28
11.8 Luggage box	2-29
11.9 Ashtray	2-29
11.10 Heater	2-29
11.11 Air conditioner	2-30
11.12 Car radio	2-33
11.13 Fuse	2-34
11.14 Fusible link	2-35
11.15 Controllers	2-35
11.16 Tool box	2-35
11.17 Refuelling pump	2-35
11.18 Handling the accumulator	2-36

5. CONTENTS

12. Operation	
12.1 Check before starting engine	2-38
12.2 Starting engine	2-48
12.3 Operations and checks after starting engine	2-51
12.4 Moving machine off	2-57
12.5 Steering machine	2-60
12.6 Stopping machine	2-62
12.7 Swinging	2-63
12.8 Operation of work equipment	2-64
12.9 Working mode selection	2-65
12.10 Prohibitions for operation	2-67
12.11 Precaution for operation	2-69
12.12 Precaution when travelling up or down hills	2-70
12.13 How to escape from mud	2-72
12.14 Work possible using hydraulic excavator	2-73
12.15 Replacement and inversion of bucket	2-74
12.16 Parking the machine	2-76
12.17 Check after finishing work	2-77
12.18 Stopping engine	2-78
12.19 Check after stopping engine	2-79
12.20 Locking	2-79
12.21 Overload warning device	2-79
13 Transportation	
13.1 Loading, unloading work	2-80
13.2 Precautions for loading	2-82
13.3 Precautions for transportation	2-83
13.4 Lifting the machine	2-83
14. Cold weather operation	
14.1 Precaution for low temperature.....	2-85
14.2 Precautions after completion of work	2-86
14.3 After cold weather	2-86
15. Long-term storage	
15.1 Before storage	2-87
15.2 During storage	2-88
15.3 After storage	2-88
15.4 Starting machine after long-term storage	2-88
16. Troubleshooting	
16.1 Phenomena that are not failures	2-89
16.2 Method of towing machine	2-89
16.3 Using method for light-weight towing hole	2-89
16.4 Precautions on particular jobsites	2-90
16.5 If battery is discharged	2-90
16.6 Other trouble	2-94

MAINTENANCE

17. Guides to maintenance	3-2
18. Outlines of service	3-5
18.1 Outline of oil, fuel, coolant	3-5
18.2 Outline of electric system	3-9
18.3 Outline of hydraulic system	3-10
19. Wear parts list	3-11
20. Use of fuel, coolant and lubricants according to ambient temperature	3-12
21. Standard tightening torques for bolts and nuts	3-16
21.1 Introduction of necessary tools	3-16
21.2 Torque list	3-17
22. Periodic replacement of safety critical parts	3-18
23. Maintenance schedule chart	3-20
23.1 Maintenance schedule chart	3-20
23.2 Maintenance interval when using hydraulic breaker	3-22
24. Service procedure	3-23
24.1 Initial 250 hours service	3-23
24.2 When required	3-24
24.3 Check before starting	3-45
24.4 Every 50 hours service	3-49
24.5 Every 100 hours service	3-51
24.6 Every 250 hours service	3-54
24.7 Every 500 hours service	3-61
24.8 Every 1000 hours service	3-67
24.9 Every 2000 hours service	3-73
24.10 Every 4000 hours	3-80

SPECIFICATIONS

25. SPECIFICATIONS	4-2
25.1 Machine specifications	4-2
25.2 Explanation of lifting capacity chart	4-5

OPTIONS AND ATTACHMENTS

26	General Precautions	5-2
26.1	General precautions related to safety	5-2
26.2	Precautions when installing attachments	5-3
27.	Handling bucket with hook	5-4
27.1	Checking for damage to bucket with hook	5-4
27.2	Prohibited operations	5-4
27.3	Precautions during operation	5-4
28	Machine ready for attachments	5-5
28.1	Explanation of components	5-5
28.2	Hydraulic circuit	5-7
28.3	Attachment mounting / dismounting procedure	5-9
28.4	Operation	5-11
28.5	Long-term storage	5-12
28.6	Specifications	5-12
29.	Introduction of attachments	5-13
29.1	Specification, use	5-13
29.2	Attachment installing combination table	5-14
29.3	Selection of track shoes	5-15
29.4	Selection of bucket teeth	5-16
29.5	Handling trapezoidal bucket	5-17
29.6	Handling extension arm	5-18
30.	Extending machine service life	5-19
30.1	Hydraulic breaker	5-19
30.2	Power ripper	5-22
30.3	Fork grab	5-23
30.4	Grapple bucket	5-24
30.5	Scrap grapple	5-25
30.6	Crusher & cutter	5-26
30.7	Hydraulic pile driver	5-27
30.8	Hydraulic excavator with multi-purpose crane	5-28

SAFETY

 **WARNING**

Read and follow all safety precautions. Failure to do so may result in serious injury or death.

This safety section also contains precautions for optional equipment and attachments.

6. GENERAL PRECAUTIONS

⚠ WARNING: For reasons of safety, always follow these safety precautions.

SAFETY RULES

- ONLY trained and authorised personnel can operate and maintain the machine.
- Follow all safety rules, precautions and instructions when operating or performing maintenance on the machine.
- When working with another operator or a person on worksite traffic duty, be sure all personnel understand all hand signals that are to be used.

SAFETY FEATURES

- Be sure all guards and covers are in their proper position. Have guards and covers repaired if damaged.
- Use safety features such as safety lock lever properly.
- NEVER remove any safety features. ALWAYS keep them in good operating condition.
Safety lever → See 12.16 “PARKING THE MACHINE”.
- Improper use of safety features could result in serious bodily injury or death.

CLOTHING AND PERSONAL PROTECTIVE ITEMS

- Avoid loose clothing, jewellery, and loose long hair. They can catch on controls or in moving parts and cause serious injury or death. Also, do not wear oily cloths because they are flammable.
- Wear a hard hat, safety glasses, safety shoes, mask or gloves when operating or maintaining the machine. Always wear safety goggles, hard hat and heavy gloves if your job involves scattering metal chips or minute materials <—> this is so particularly when driving pins with a hammer and when cleaning the air cleaner element with compressed air.
Check also that there is no one near the machine.
Driving in pins, See → 12.15 “REPLACEMENT AND INVERSION OF BUCKET’.
Cleaning of air cleaner element, See → 24.2 “WHEN REQUIRED” in service procedure.

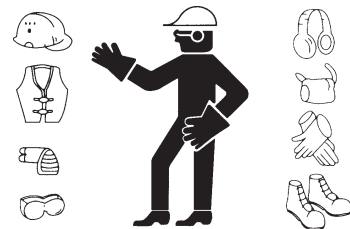

⚠ WARNING: Failure to follow these safety precautions may lead to a serious accident.

UNAUTHORISED MODIFICATION

- Any modification made without authorisation from Komatsu can create hazards.
- Before making a modification, consult your Komatsu distributor. Komatsu will not be responsible for any injury or damage caused by any unauthorised modification.

ALWAYS APPLY LOCK WHEN LEAVING OPERATOR'S SEAT

- When standing up from the operator's seat, always place the safety lock lever securely in the LOCK position. If you accidentally touch the travel or swing lever when they are not locked, the work equipment may suddenly move and cause serious injury or damage.
- When leaving the machine, lower the work equipment completely to the ground, set the safety lock lever to the LOCK position, then stop the engine and use the key to lock all the equipment. Always take the key with you. Work equipment posture **See** → 12.16 "PARKING THE MACHINE."

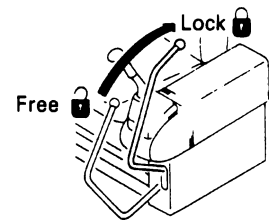

MOUNTING AND DISMOUNTING

- NEVER jump on or off the machine. NEVER get on or off a moving machine.
- When mounting or dismounting, always face the machine and use the handrails, machine or track frame steps, and track shoes.
- Do not hold any control levers when getting on or off the machine.
- Ensure safety by always maintaining at least three-point contact of hands and feet with the handrails, steps or track shoes.
- Always remove any oil or mud from the handrails, steps and track shoes. If they are damaged, repair them and tighten any loose bolts.
- If grasping the door handrail when mounting or dismounting or moving on the track, open and lock the door securely in the open position. Otherwise, the door may move suddenly, causing you to lose balance and fall.

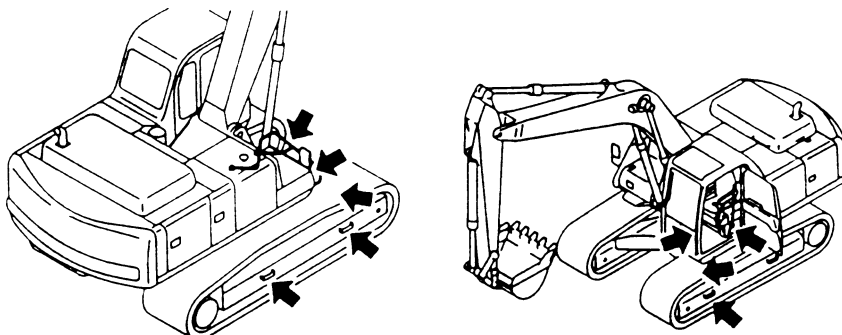

FIRE PREVENTION FOR FUEL AND OIL

Fuel, oil, and antifreeze can be ignited by a flame. Fuel is particularly **FLAMMABLE** and can be **HAZARDOUS**.

- Keep flames away from flammable fluids.
- Stop the engine and do not smoke when refuelling.
- Tighten all fuel and oil caps securely.
- Refuelling and oiling should be carried out in well ventilated areas.
- Keep oil and fuel in a secure place and do not allow unauthorised persons to enter.

**PRECAUTIONS WHEN HANDLING AT HIGH TEMPERATURES**

- Immediately after operations are stopped, the engine coolant, engine oil, and hydraulic oil are at high temperatures, and are still under pressure. Attempting to remove the cap, drain the oil or water, or replace the filters may lead to serious burns. Always wait for the temperature to go down, and follow the specified procedures when carrying out these operations.
- To prevent hot water from spurting out:
 - 1) Turn engine off.
 - 2) Allow water to cool.
 - 3) Slowly loosen cap to relieve pressure before removing.
- To prevent hot oil from spurting out:
 - 1) Turn engine off.
 - 2) Allow oil to cool.
 - 3) Slowly loosen cap to relieve pressure before removing.



ASBESTOS DUST HAZARD PREVENTION

Asbestos dust can be HAZARDOUS to your health if it is inhaled. Your Komatsu machine and genuine Komatsu spare parts do not contain any asbestos. Use only genuine Komatsu spare parts. If spare parts containing asbestos are used, the following precautions must be observed:

- NEVER use compressed air for cleaning.
- Use water for cleaning to keep down the dust.
- Operate the machine with the wind to your back, whenever possible.
- Use an approved respirator if necessary.



CRUSHING OR CUTTING PREVENTION

- Do not enter, or put your hand or arm or any other part of your body between movable parts such as between the work equipment and cylinders, or between the machine and work equipment. If the work equipment is operated, the clearance will change and this may lead to serious damage or personal injury.



FIRE EXTINGUISHER AND FIRST AID KIT

- Know how to use fire extinguisher (if installed).
- Provide a first aid kit at the storage point.
- Know what to do in the event of a fire.
- Be sure you know the phone numbers of persons you should contact in case of an emergency.



PROTECTION AGAINST FALLING OR FLYING OBJECTS

If there is any danger of falling or flying objects hitting the operator, install protective guards in place to protect the operator as required for each particular situation.

- For work with breakers, install a front guard on the windshield. Also, place a laminate coating sheet over the windshield.
- For demolition or shear work, install a front guard on the windshield and a top guard on the cab. Also, place a laminate coating sheet over the windshield.
- For work in mines, quarries, demolition, tunnels or other places where there is danger of falling rocks, put FOPS (falling object protective structure) in place. Also, place a laminate coating sheet over the windshield.

The above comments are made with regards to typical working conditions. By all means you should put on other guards if required by conditions at your particular site.

For details of safety guards, please contact your Komatsu distributor.

Also, even for other types of work, if there is any danger of being hit by falling or flying objects or of objects entering the operator's cab, select and install a guard that matches the working conditions.

Be sure to close the front window before commencing work.

When carrying out the above operations, make sure to keep all persons other than the operator outside the range of falling or flying objects. Be particularly sure to maintain a proper distance when carrying out shear operations.

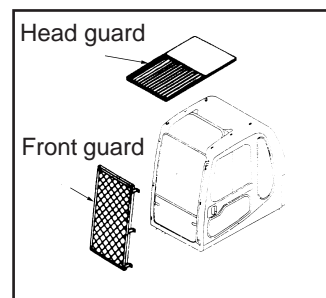
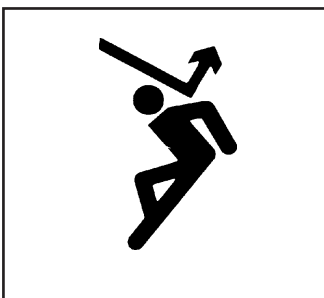
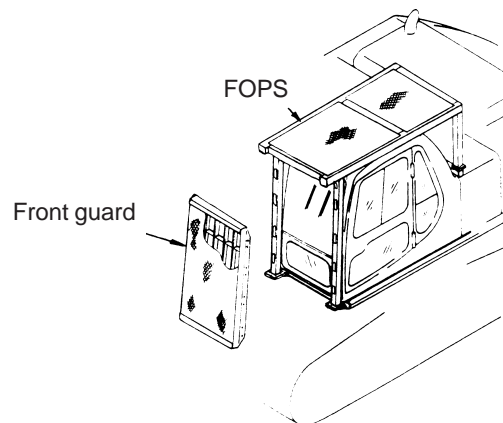
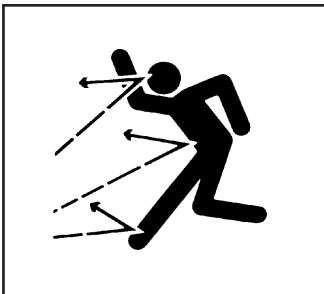

PRECAUTIONS FOR ATTACHMENTS

- When installing and using an optional attachment, read the instruction manual for the attachment and the information related to attachments in this manual.
- Do not use attachments that are not authorised by Komatsu or your Komatsu distributor. Use of unauthorised attachments could create a safety problem and adversely affect the proper operation and useful life of the machine.
- Any injuries, accidents, product failures resulting from the use of unauthorised attachments will not be the responsibility of Komatsu.

MACHINES WITH ACCUMULATOR

On machines equipped with an accumulator, for a short time after the engine is stopped, the work equipment will lower under its own weight when the work equipment control lever is shifted to LOWER. After the engine is stopped, set the safety lock lever to the lock position (and also lock the attachment pedal with the lock pin).

When releasing the pressure inside the work equipment circuit on machines equipped with an accumulator, follow the procedure given in the inspection and maintenance section.

Method of releasing pressure → See 11.19 “HANDLING THE ACCUMULATOR”.

The accumulator is filled with high-pressure nitrogen gas, and it is extremely dangerous if it is handled in the wrong way. Always observe the following precautions.

- Never make any hole in the accumulator or expose it to flame or fire.
- Do not weld anything to the accumulator.
- When carrying out disassembly or maintenance of the accumulator, or when disposing of the accumulator, it is necessary to release the gas from the accumulator. A special air bleed valve is necessary for this operation, so please contact your Komatsu distributor.

Gas in accumulator → See 11.19 “HANDLING THE ACCUMULATOR”.

EMERGENCY EXIT

- When exit by normal means is prevented in an emergency you can get out through the emergency exit (rear window).
- Pull the ring at the bottom of the window and remove strip. This will allow you to push out glass.

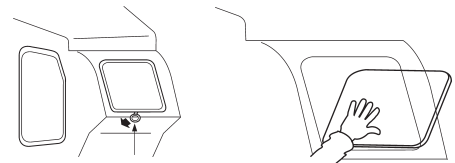

ROTATING BEACON (OPTION)

- When the machine is operated on or beside a road, a rotating beacon is required to avoid a traffic accident.
- Contact your Komatsu distributor to install beacon lamp.

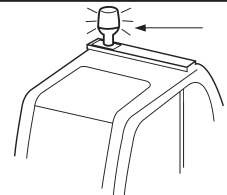

ELECTROMAGNETIC INTERFERENCE

When this machine is operating close to a source of high electromagnetic interference, such as a radar station, some abnormal phenomena may be observed.

- The display on the monitor panel may behave erratically.
- The warning buzzer may sound.

These effects do not signify a malfunction and the machine will return to normal as soon as the source of interference is removed.

7. PRECAUTIONS DURING OPERATION

7.1 BEFORE STARTING ENGINE

SAFETY AT WORKSITE

- Before starting the engine, thoroughly check the area for any unusual conditions that could be dangerous.
- Before starting the engine, examine the terrain and soil conditions of the worksite. Determine the best and safest method of operation.
- Make the slope as horizontal as possible before continuing operations.
- If you need to operate on a street, protect pedestrians and cars by designating a person for worksite traffic duty or by installing fences around the worksite.
- If water lines, gas lines, and high-voltage electrical lines may be buried under the worksite, contact each utility and identify their locations. Be careful not to sever or cut any of these lines.
- Check the depth and flow of water before operating in water or crossing a river. NEVER be in water which is in excess of the permissible water depth.

Permissible water depth

See → 12.11 "PRECAUTIONS FOR OPERATION."

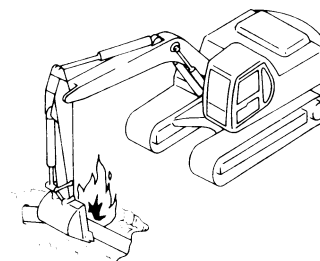

FIRE PREVENTION

- Thoroughly remove wood chips, leaves, paper and other flammable things accumulated on the engine compartment. They could cause a fire.
- Check fuel, lubrication, and hydraulic systems for leaks. Have any leaks repaired. Wipe up any excess oil, fuel or other flammable fluids.

Check point → See 12.1.1 "WALK-AROUND CHECK."

- Be sure a fire extinguisher is present and working.



IN OPERATOR'S CAB

- Do not leave tools or spare parts lying around in the operator's compartment. They may damage or break the control levers or switches. Always put them in the tool box on the left side of the machine.
- Keep the cab floor, controls, steps and handrails free of oil, grease, snow, and excess dirt.