

Shop Manual

ARTICULATED
DUMP TRUCK

HM250-2

SERIAL NUMBERS 2001 and up

ecot3

KOMATSU

ARTICULATED DUMP TRUCK

HM250-2

Machine model Serial number

HM250-2 2001 and up

00 Index and foreword

100 Index

Composition of shop manual	2
Table of contents	3

Composition of shop manual

The contents of this shop manual are shown together with Form No. in a list.

Note 1: Always keep the latest version of this manual in accordance with this list and utilize accordingly.

The marks shown to the right of Form No. denote the following:

○: New issue (to be filed additionally) ●: Revision (to be replaced for each Form No.)

Note 2: This shop manual can be supplied for each Form No.

Note 3: To file this shop manual in the special binder for management, handle it as follows:

- Place a divider on the top of each section in the file after matching the Tub No. with No. indicated next to each Section Name shown in the table below:
- File overview and other materials in sections in the order shown below and utilize them accordingly.

Section Title	Form Number
Shop Manual, contents binder, binder label and tabs	SEN04733-00
00 Index and foreword	SEN04734-00
100 Index	SEN04735-00
200 Foreword and general information	SEN04736-00
01 Specification	SEN04737-00
100 Specification and technical data	SEN04738-00
10 Structure, function and maintenance standard	SEN04739-00
100 Engine and cooling system	SEN04740-00
201 Power train, Part 1	SEN04741-00
202 Power train, Part 2	SEN04742-00
300 Steering system	SEN04743-00
400 Brake system	SEN04744-00
500 Undercarriage and frame	SEN04745-00
600 Hydraulic system	SEN04746-00
700 Cab and its attachments	SEN04747-00
801 Electrical system, Part 1	SEN04748-00
802 Electrical system, Part 2	SEN04749-00
803 Electrical system, Part 3	SEN04750-00
90 Diagrams and drawings	SEN04755-00
100 Hydraulic diagrams and drawings	SEN04756-00
200 Electrical diagrams and drawings	SEN04757-00

Table of contents

00 Index and foreword	
100 Index	SEN04735-00
Composition of shop manual.....	2
Table of contents	3
200 Foreword and general information	SEN04736-00
Safety notice	2
How to read the shop manual	7
Explanation of terms for maintenance standard.....	9
Handling of electric equipment and hydraulic component.....	11
Handling of connectors newly used for engines.....	20
How to read electric wire code	23
Precautions when carrying out operation.....	26
Method of disassembling and connecting push-pull type coupler.....	29
Standard tightening torque table	32
Conversion table	36
01 Specification	
100 Specification and technical data	SEN04738-00
Specification drawings.....	2
Specifications	3
Weight table	6
Fuel, coolant and lubricants	7
10 Structure, function and maintenance standard	
100 Engine and cooling system	SEN04740-00
Radiator, oil cooler, aftercooler.....	2
Output shaft.....	3
201 Power train, Part 1	SEN04741-00
Power train skeleton.....	2
Torque converter and transmission hydraulic piping	4
Brake cooling oil control valve (BCV).....	6
Power train pump	7
Torque converter	10
Transmission	16
Transmission control valve.....	44
ECMV	46
Main relief, torque converter relief valve	53
202 Power train, Part 2	SEN04742-00
Drive shaft	2
Axle	3
Differential	6
Limited slip differential.....	12
Final drive.....	16
300 Steering system	SEN04743-00
Steering column	2
400 Brake system	SEN04744-00
Brake piping	2
Brake valve	4
Accumulator charge valve.....	7
Accumulator	11
Slack adjuster.....	12
Brake.....	14

Proportional reducing valve.....	19
Brake system tank.....	20
Parking brake.....	22
Parking brake solenoid.....	26
500 Undercarriage and frame	SEN04745-00
Suspension.....	2
Suspension cylinder.....	8
Oscillation hitch.....	10
600 Hydraulic system	SEN04746-00
Steering, hoist oil pressure piping diagram.....	2
Dump body control.....	3
Hydraulic tank and filter.....	4
Flow amp valve.....	5
Steering valve.....	8
Steering cylinder.....	12
Hoist valve.....	14
EPC valve.....	20
Hoist cylinder.....	22
Hydraulic pump.....	23
700 Cab and its attachments	SEN04747-00
ROPS cab.....	2
Cab tilt.....	3
Air conditioner.....	4
Rear view monitor.....	12
Controller related.....	15
801 Electrical system, Part 1	SEN04748-00
Machine monitor system.....	2
802 Electrical system, Part 2	SEN04749-00
Automatic shift control system.....	2
Retarder control system.....	34
Auto emergency steering system.....	46
Battery disconnecter switch.....	48
Dump control lever.....	50
803 Electrical system, Part 3	SEN04750-00
Sensors, switches.....	2
KOMTRAX terminal system (If equipped).....	10
90 Diagrams and drawings	
100 Hydraulic diagrams and drawings	SEN04756-00
Power train hydraulic circuit diagram.....	3
Steering and hoist hydraulic circuit diagram.....	5
Brake hydraulic circuit diagram.....	7
Brake cooling hydraulic circuit diagram.....	9
200 Electrical diagrams and drawings	SEN04757-00
Electrical circuit diagram for inside cab (1/4).....	3
Electrical circuit diagram for inside cab (2/4).....	5
Electrical circuit diagram for inside cab (3/4).....	7
Electrical circuit diagram for inside cab (4/4).....	9
Electrical circuit diagram for outside cab (1/3).....	11
Electrical circuit diagram for outside cab (2/3).....	13
Electrical circuit diagram for outside cab (3/3).....	15

HM250-2 Articulated dump truck

Form No. SEN04735-00

© 2008 KOMATSU
All Rights Reserved
Printed in Japan 09-08 (02)

ARTICULATED DUMP TRUCK

HM250-2

Machine model Serial number

HM250-2 2001 and up

00 Index and foreword

200 Foreword and general information

Safety notice	2
How to read the shop manual	7
Explanation of terms for maintenance standard	9
Handling of electric equipment and hydraulic component	11
Handling of connectors newly used for engines	20
How to read electric wire code	23
Precautions when carrying out operation	26
Method of disassembling and connecting push-pull type coupler	29
Standard tightening torque table	32
Conversion table	36

Safety notice

(Rev. 2008/08)

Important safety notice

Proper service and repair are extremely important for safe machine operation. The service and repair techniques recommended by Komatsu and described in this manual are both effective and safe. Some of these techniques require the use of tools specially designed by Komatsu for the specific purpose.

To prevent injury to workers, the symbol  is used to mark safety precautions in this manual. The cautions accompanying these symbols should always be followed carefully. If any dangerous situation arises or may possibly arise, first consider safety, and take the necessary actions to deal with the situation.

1. General precautions

 **Mistakes in operation are extremely dangerous. Read the Operation and Maintenance Manual carefully before operating the machine. In addition, read this manual and understand its contents before starting the work.**

- 1) Before carrying out any greasing or repairs, read all the safety labels stuck to the machine. For the locations of the safety labels and detailed explanation of precautions, see the Operation and Maintenance Manual.
- 2) Decide a place in the repair workshop to keep tools and removed parts. Always keep the tools and parts in their correct places. Always keep the work area clean and make sure that there is no dirt, water, or oil on the floor. Smoke only in the areas provided for smoking. Never smoke while working.
- 3) When carrying out any operation, always wear safety shoes and helmet. Do not wear loose work clothes, or clothes with buttons missing.
 - Always wear safety glasses when hitting parts with a hammer.
 - Always wear safety glasses when grinding parts with a grinder, etc.
- 4) When carrying out any operation with 2 or more workers, always agree on the operating procedure before starting. Always inform your fellow workers before starting any step of the operation. Before starting work, hang UNDER REPAIR warning signs in the operator's compartment.
- 5) Only qualified workers must carry out work and operation which require license or qualification.
- 6) Keep all tools in good condition, learn the correct way to use them, and use the proper ones of them. Before starting work, thoroughly check the tools, machine, forklift, service car, etc.
- 7) If welding repairs are needed, always have a trained and experienced welder carry out the work. When carrying out welding work, always wear welding gloves, apron, shielding goggles, cap and other clothes suited for welding work.
- 8) Before starting work, warm up your body thoroughly to start work under good condition.
- 9) Avoid continuing work for long hours and take rests at proper intervals to keep your body in good condition. Take rests in specified safe places.

Safety points

1	Good arrangement
2	Correct work clothes
3	Following work standard
4	Making and checking signs
5	Prohibition of operation and handling by unlicensed workers
6	Safety check before starting work
7	Wearing protective goggles (for cleaning or grinding work)
8	Wearing shielding goggles and protectors (for welding work)
9	Good physical condition and preparation
10	Precautions against work which you are not used to or you are used to too much

2. Preparations for work

- 1) Before adding oil or making any repairs, park the machine on a hard and level ground, and apply the parking brake and block the wheels or tracks to prevent the machine from moving.
- 2) Before starting work, lower the work equipment (blade, ripper, bucket, etc.) to the ground. If this is not possible, insert the lock pin or use blocks to prevent the work equipment from falling. In addition, be sure to lock all the control levers and hang warning signs on them.
- 3) When disassembling or assembling, support the machine with blocks, jacks, or stands before starting work.
- 4) Remove all mud and oil from the steps or other places used to get on and off the machine. Always use the handrails, ladders or steps when getting on or off the machine. Never jump on or off the machine. If it is impossible to use the handrails, ladders or steps, use a stand to provide safe footing.

3. Precautions during work

- 1) Before disconnecting or removing components of the oil, water, or air circuits, first release the pressure completely from the circuit. When removing the oil filler cap, a drain plug, or an oil pressure pickup plug, loosen it slowly to prevent the oil from spurting out.
- 2) The coolant and oil in the circuits are hot when the engine is stopped, so be careful not to get scalded. Wait for the oil and coolant to cool before carrying out any work on the oil or water circuits.
- 3) Before starting work, stop the engine. When working on or around a rotating part, in particular, stop the engine. When checking the machine without stopping the engine (measuring oil pressure, revolving speed, temperature, etc.), take extreme care not to get rolled or caught in rotating parts or moving parts.
- 4) Before starting work, remove the leads from the battery. Always remove the lead from the negative (-) terminal first.
- 5) When raising a heavy component (heavier than 25 kg), use a hoist or crane. Before starting work, check that the slings (wire ropes, chains, and hooks) are free from damage. Always use slings which have ample capacity and install them to proper places. Operate the hoist or crane slowly to prevent the component from hitting any other part. Do not work with any part still raised by the hoist or crane.

- 6) When removing a cover which is under internal pressure or under pressure from a spring, always leave 2 bolts in diagonal positions. Loosen those bolts gradually and alternately to release the pressure, and then remove the cover.
- 7) When removing components, be careful not to break or damage the electrical wiring. Damaged wiring may cause electrical fires.
- 8) When removing piping, stop the fuel or oil from spilling out. If any fuel or oil drips onto the floor, wipe it up immediately. Fuel or oil on the floor can cause you to slip and can even start fires.
- 9) As a general rule, do not use gasoline to wash parts. Do not use it to clean electrical parts, in particular.
- 10) Be sure to assemble all parts again in their original places. Replace any damaged parts and parts which must not be reused with new parts. When installing hoses and wires, be sure that they will not be damaged by contact with other parts when the machine is operated.
- 11) When installing high pressure hoses, make sure that they are not twisted. Damaged tubes are dangerous, so be extremely careful when installing tubes for high pressure circuits. In addition, check that connecting parts are correctly installed.
- 12) When assembling or installing parts, always tighten them to the specified torques. When installing protective parts such as guards, or parts which vibrate violently or rotate at high speed, be particularly careful to check that they are installed correctly.
- 13) When aligning 2 holes, never insert your fingers or hand. Be careful not to get your fingers caught in a hole.
- 14) When measuring hydraulic pressure, check that the measuring tools are correctly assembled.
- 15) Take care when removing or installing the tracks of track-type machines. When removing the track, the track separates suddenly, so never let anyone stand at either end of the track.
- 16) If the engine is operated for a long time in a place which is not ventilated well, you may suffer from gas poisoning. Accordingly, open the windows and doors to ventilate well.

4. Precautions for sling work and making signs

1) Only one appointed worker must make signs and co-workers must communicate with each other frequently. The appointed sign maker must make specified signs clearly at a place where he is well seen from the operator's seat and where he can see the working condition easily. The sign maker must always stand in front of the load and guide the operator safely.

- Do not stand under the load.
- Do not step on the load.

- 2) Check the slings before starting sling work.
- 3) Keep putting on gloves during sling work. (Put on leather gloves, if available.)
- 4) Measure the weight of the load by the eye and check its center of gravity.
- 5) Use proper sling according to the weight of the load and method of slinging. If too thick wire ropes are used to sling a light load, the load may slip and fall.
- 6) Do not sling a load with 1 wire rope alone. If it is slung so, it may rotate and may slip out of the rope. Install 2 or more wire ropes symmetrically.

⚠ Slinging with 1 rope may cause turning of the load during hoisting, untwisting of the rope, or slipping of the rope from its original winding position on the load, which can result in a dangerous accident.

- 7) Limit the hanging angle to 60°, as a rule. Do not sling a heavy load with ropes forming a wide hanging angle from the hook. When hoisting a load with 2 or more ropes, the force subjected to each rope will increase with the hanging angle. The table below shows the variation of allowable load in kN {kg} when hoisting is made with 2 ropes, each of which is allowed to sling up to 9.8 kN {1,000 kg} vertically, at various hanging angles. When the 2 ropes sling a load vertically, up to 19.6 kN {2,000 kg} of total weight can be suspended. This weight is reduced to 9.8 kN {1,000 kg} when the 2 ropes make a hanging angle of 120°. If the 2 ropes sling a 19.6 kN {2,000 kg} load at a lifting angle of 150°, each of them is subjected to a force as large as 39.2 kN {4,000 kg}.

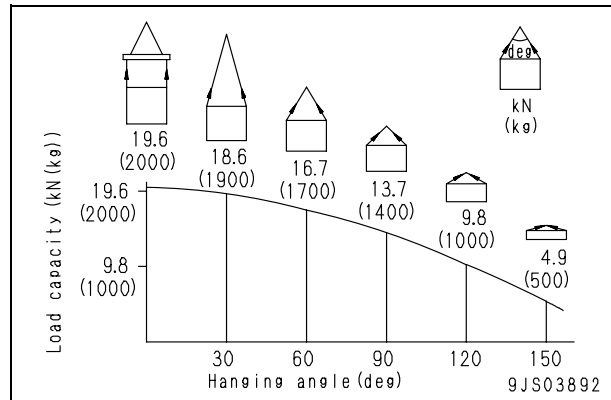

- 8) When installing wire ropes to an angular load, apply pads to protect the wire ropes. If the load is slippery, apply proper material to prevent the wire rope from slipping.
- 9) Use the specified eyebolts and fix wire ropes, chains, etc. to them with shackles, etc.
- 10) Apply wire ropes to the middle portion of the hook.
 - Slinging near the tip of the hook may cause the rope to slip off the hook during hoisting. The hook has the maximum strength at the middle portion.

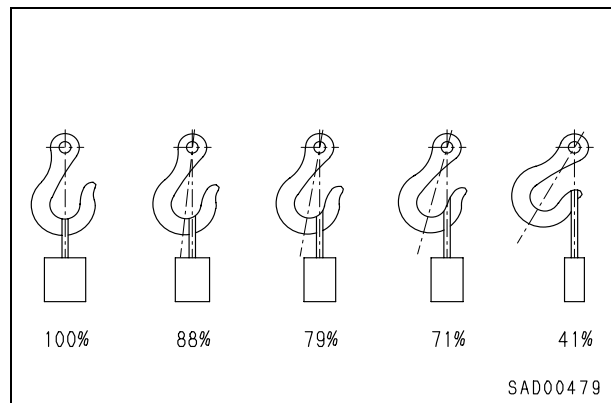

- 11) Do not use twisted or kinked wire ropes.
- 12) When lifting up a load, observe the following.
 - Wind in the crane slowly until wire ropes are stretched. When settling the wire ropes with the hand, do not grasp them but press them from above. If you grasp them, your fingers may be caught.
 - After the wire ropes are stretched, stop the crane and check the condition of the slung load, wire ropes, and pads.

- If the load is unstable or the wire rope or chains are twisted, lower the load and lift it up again.
 - Do not lift up the load slantingly.
- 13) When lifting down a load, observe the following.
- When lifting down a load, stop it temporarily at 30 cm above the floor, and then lower it slowly.
 - Check that the load is stable, and then remove the sling.
 - Remove kinks and dirt from the wire ropes and chains used for the sling work, and put them in the specified place.

5. Precautions for using mobile crane

- ★ Read the Operation and Maintenance Manual of the crane carefully in advance and operate the crane safely.

6. Precautions for using overhead hoist crane

▲ When raising a heavy part (heavier than 25 kg), use a hoist, etc. In Disassembly and assembly, the weight of a part heavier than 25 kg is indicated after the mark of .

- 1) Before starting work, inspect the wire ropes, brake, clutch, controller, rails, over wind stop device, electric shock prevention earth leakage breaker, crane collision prevention device, and power application warning lamp, and check safety.
- 2) Observe the signs for sling work.
- 3) Operate the hoist at a safe place.
- 4) Check the direction indicator plates (east, west, south, and north) and the directions of the control buttons without fail.
- 5) Do not sling a load slantingly. Do not move the crane while the slung load is swinging.
- 6) Do not raise or lower a load while the crane is moving longitudinally or laterally.
- 7) Do not drag a sling.
- 8) When lifting up a load, stop it just after it leaves the ground and check safety, and then lift it up.
- 9) Consider the travel route in advance and lift up a load to a safe height.
- 10) Place the control switch on a position where it will not be an obstacle to work and passage.
- 11) After operating the hoist, do not swing the control switch.
- 12) Remember the position of the main switch so that you can turn off the power immediately in an emergency.

- 13) If the hoist stops because of a power failure, turn the power switch OFF. When turning on a switch which was turned OFF by the electric shock prevention earth leakage breaker, check that the devices related to that switch are not in operation state.
- 14) If you find an obstacle around the hoist, stop the operation.
- 15) After finishing the work, stop the hoist at the specified position and raise the hook to at least 2 m above the floor. Do not leave the sling installed to the hook.

7. Selecting wire ropes

- 1) Select adequate ropes depending on the weight of parts to be hoisted, referring to the table below.

Wire ropes
(Standard "Z" twist ropes without galvanizing)
(JIS G3525, No. 6, Type 6X37-A)

Nominal diameter of rope mm	Allowable load	
	kN	ton
10	8.8	0.9
12	12.7	1.3
14	17.3	1.7
16	22.6	2.3
18	28.6	2.9
20	35.3	3.6
25	55.3	5.6
30	79.6	8.1
40	141.6	14.4
50	221.6	22.6
60	318.3	32.4

- ★ The allowable load is one-sixth of the breaking strength of the rope used (Safety coefficient: 6).

8. Precautions for disconnecting and connecting hoses and tubes in air conditioner circuit

1) Disconnection

⚠ For the environment, the air conditioner of this machine uses the refrigerant (air conditioner gas: R134a) which has fewer factors of the depletion of the ozone layer. However, it does not mean that you may discharge the refrigerant into the atmosphere as it is. Be sure to recover the refrigerant when disconnecting the refrigerant gas circuit and then reuse it.

★ Ask professional traders for collecting and filling operation of refrigerant (R134a).

★ Never release the refrigerant (R134a) to the atmosphere.

⚠ If the refrigerant gas gets in your eyes or contacts your skin, you may lose your sight and your skin may be frozen. Accordingly, put on safety glasses, safety gloves and safety clothes when recovering or adding the refrigerant. Refrigerant gas must be recovered and added by a qualified person.

2) Connection

1] When installing the air conditioner circuit hoses and tubes, take care that dirt, dust, water, etc. will not enter them.

2] When connecting the air conditioner hoses and tubes, check that O-rings (1) are fitted to their joints.

3] Check that each O-ring is not damaged or deteriorated.

4] When connecting the refrigerant piping, apply compressor oil for refrigerant (R134a) (**DENSO: ND-OIL8, VALEO THERMAL SYSTEMS: ZXL100PG (equivalent to PAG46)**) to its O-rings.

★ Example of O-ring (Fitted to every joint of hoses and tubes)

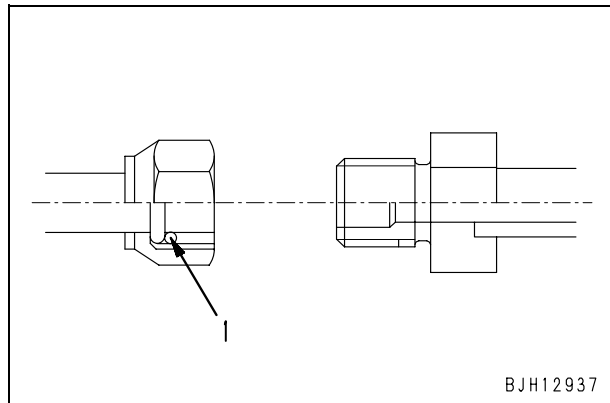

★ For tightening torque, see the precautions for installation in each section of "Disassembly and assembly".

How to read the shop manual

- Some attachments and optional parts in this shop manual may not be delivered to certain areas. If one of them is required, consult KOMATSU distributors.
- Materials and specifications are subject to change without notice.
- Shop manuals are divided into the “Chassis volume” and “Engine volume”. For the engine unit, see the engine volume of the engine model mounted on the machine.

1. Composition of shop manual

This shop manual contains the necessary technical information for services performed in a workshop. For ease of understanding, the manual is divided into the following sections.

00. Index and foreword

This section explains the shop manuals list, table of contents, safety, and basic information.

01. Specification

This section explains the specifications of the machine.

10. Structure, function and maintenance standard

This section explains the structure, function, and maintenance standard values of each component. The structure and function sub-section explains the structure and function of each component. It serves not only to give an understanding of the structure, but also serves as reference material for troubleshooting. The maintenance standard sub-section explains the criteria and remedies for disassembly and service.

20. Standard value table

This section explains the standard values for new machine and judgement criteria for testing, adjusting, and troubleshooting. This standard value table is used to check the standard values in testing and adjusting and to judge parts in troubleshooting.

30. Testing and adjusting

This section explains measuring instruments and measuring methods for testing and adjusting, and method of adjusting each part. The standard values and judgement criteria for testing and adjusting are explained in Testing and adjusting.

40. Troubleshooting

This section explains how to find out failed parts and how to repair them. The troubleshooting is divided by failure modes. The “S mode” of the troubleshooting related to the engine may be also explained in the Chassis volume and Engine volume. In this case, see the Chassis volume.

50. Disassembly and assembly

This section explains the special tools and procedures for removing, installing, disassembling, and assembling each component, as well as precautions for them. In addition, tightening torque and quantity and weight of coating material, oil, grease, and coolant necessary for the work are also explained.

90. Diagrams and drawings (chassis volume)/Repair and replacement of parts (engine volume)

- Chassis volume
This section gives hydraulic circuit diagrams and electrical circuit diagrams.
- Engine volume
This section explains the method of reproducing, repairing, and replacing parts.

2. Revision and distribution

Any additions, revisions, or other change of notices will be sent to KOMATSU distributors. Get the most up-to-date information before you start any work.

3. Filing method

File by the brochures in the correct order of the form number printed in the shop manual composition table.

- **Revised edition mark**







When a manual is revised, the ones and tens digits of the form number of each brochure is increased by 1. (Example: 00, 01, 02 ...)

- **Revisions**

Revised brochures are shown in the shop manual composition table.

4. Symbols

Important safety and quality portions are marked with the following symbols so that the shop manual will be used practically.

Symbol	Item	Remarks
	Safety	Special safety precautions are necessary when performing work.
	Caution	Special technical precautions or other precautions for preserving standards are necessary when performing work.
	Weight	Weight of parts of component or parts. Caution necessary when selecting hoisting wire, or when working posture is important, etc.
	Tightening torque	Places that require special attention for tightening torque during assembly.
	Coat	Places to be coated with adhesives, etc. during assembly.
	Oil, coolant	Places where oil, etc. must be added, and capacity.
	Drain	Places where oil, etc. must be drained, and quantity to be drained.

5. Units

In this shop manual, the units are indicated with International System of units (SI). For reference, conventionally used Gravitational System of units is indicated in parentheses { }.

Explanation of terms for maintenance standard

The maintenance standard chapter explains the criteria for replacing or reusing products and parts in the machine maintenance work. The following terms are used to explain the criteria.

1. Standard size and tolerance

- To be accurate, the finishing size of parts is a little different from one to another.
- To specify a finishing size of a part, a temporary standard size is set and an allowable difference from that size is indicated.
- The above size set temporarily is called the “standard size” and the range of difference from the standard size is called the “tolerance”.
- The tolerance with the symbols of + or – is indicated on the right side of the standard size.

Example:

Standard size	Tolerance
120	-0.022 -0.126

- ★ The tolerance may be indicated in the text and a table as [standard size (upper limit of tolerance/lower limit of tolerance)].
 Example) 120 (-0.022/-0.126)
- Usually, the size of a hole and the size of the shaft to be fitted to that hole are indicated by the same standard size and different tolerances of the hole and shaft. The tightness of fit is decided by the tolerance.
- Indication of size of rotating shaft and hole and relationship drawing of them

Example:

Standard size	Tolerance	
	Shaft	Hole
60	-0.030 -0.076	+0.046 0

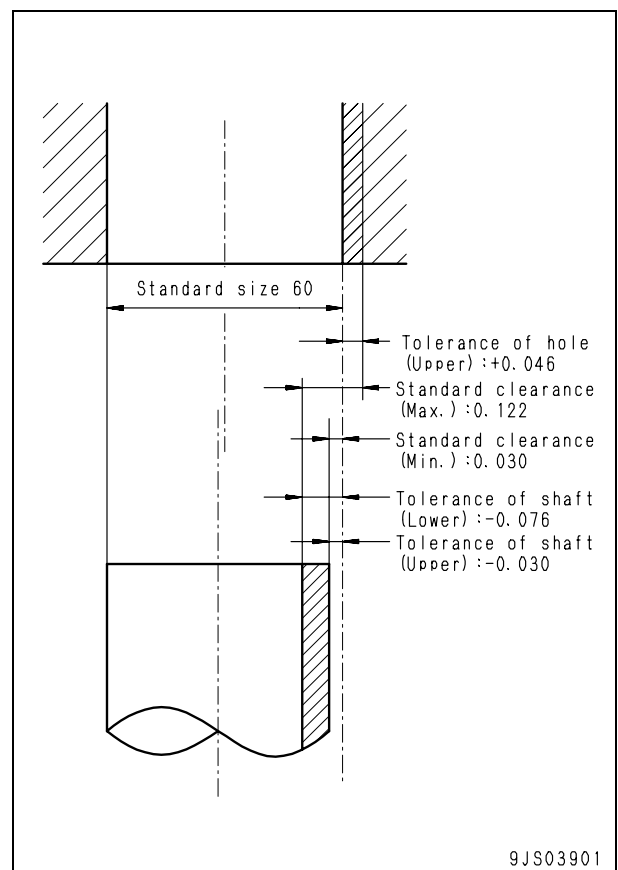

2. Standard clearance and standard value

- The clearance made when new parts are assembled is called the "standard clearance", which is indicated by the range from the minimum clearance to the maximum clearance.
- When some parts are repaired, the clearance is generally adjusted to the standard clearance.
- A value of performance and function of new products or equivalent is called the "standard value", which is indicated by a range or a target value.
- When some parts are repaired, the value of performance/function is set to the standard value.

3. Standard interference

- When the diameter of a hole of a part shown in the given standard size and tolerance table is smaller than that of the mating shaft, the difference between those diameters is called the "interference".
- The range (A – B) from the difference (A) between the minimum size of the shaft and the maximum size of the hole to the difference (B) between the maximum size of the shaft and the minimum size of the hole is the "standard interference".
- After repairing or replacing some parts, measure the size of their hole and shaft and check that the interference is in the standard range.

4. Repair limit and allowable value or allowable dimension

- The size of a part changes because of wear and deformation while it is used. The limit of changed size is called the "repair limit".
- If a part is worn to the repair limit, it must be replaced or repaired.
- The performance and function of a product lowers while it is used. A value which the product can be used without causing a problem is called the "allowable value" or "allowable dimension".
- If a product is worn to the allowable value, it must be checked or repaired. Since the permissible value is estimated from various tests or experiences in most cases, however, it must be judged after considering the operating condition and customer's requirement.

5. Clearance limit

- Parts can be used until the clearance between them is increased to a certain limit. The limit at which those parts cannot be used is called the "clearance limit".
- If the clearance between the parts exceeds the clearance limit, they must be replaced or repaired.

6. Interference limit

- The allowable maximum interference between the hole of a part and the shaft of another part to be assembled is called the "interference limit".
- The interference limit shows the repair limit of the part of smaller tolerance.
- If the interference between the parts exceeds the interference limit, they must be replaced or repaired.

Handling of electric equipment and hydraulic component

To maintain the performance of the machine over a long period, and to prevent failures or other troubles before they occur, correct “operation“, “maintenance and inspection“, “troubleshooting“, and “repairs” must be carried out. This section deals particularly with correct repair procedures for mechatronics and is aimed at improving the quality of repairs. For this purpose, it gives sections on “Handling electric equipment” and “Handling hydraulic equipment” (particularly gear oil and hydraulic oil).

Points to remember when handling electric equipment

1. Handling wiring harnesses and connectors

Wiring harnesses consist of wiring connecting one component to another component, connectors used for connecting and disconnecting one wire from another wire, and protectors or tubes used for protecting the wiring.

Compared with other electrical components fitted in boxes or cases, wiring harnesses are more likely to be affected by the direct effects of rain, water, heat, or vibration. Furthermore, during inspection and repair operations, they are frequently removed and installed again, so they are likely to suffer deformation or damage. For this reason, it is necessary to be extremely careful when handling wiring harnesses.

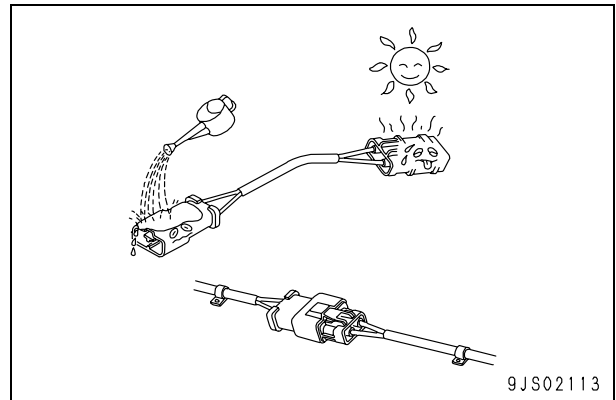

2. Main failures occurring in wiring harness

1) Defective contact of connectors (defective contact between male and female)

Problems with defective contact are likely to occur because the male connector is not properly inserted into the female connector, or because one or both of the connectors is deformed or the position is not correctly aligned, or because there is corrosion or oxidization of the contact surfaces. The corroded or oxidized contact surfaces may become shiny again (and contact may become normal) by connecting and disconnecting the connector about 10 times.

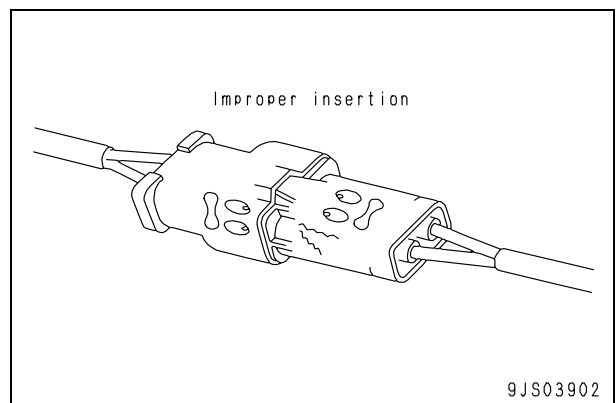

2) Defective crimping or soldering of connectors

The pins of the male and female connectors are in contact at the crimped terminal or soldered portion, but if there is excessive force brought to bear on the wiring, the plating at the joint will peel and cause improper connection or breakage.

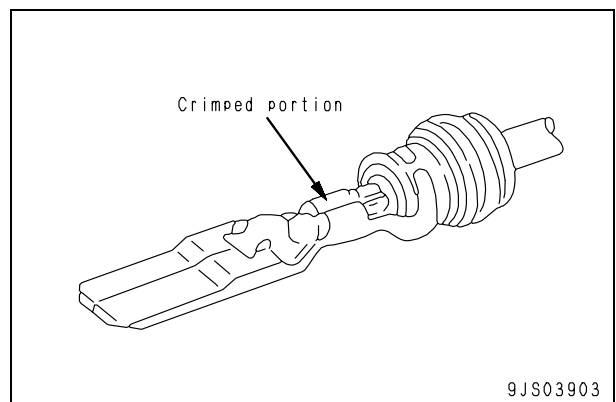

3) Disconnections in wiring

If the wiring is held and the connectors are pulled apart, or components are lifted with a crane with the wiring still connected, or a heavy object hits the wiring, the crimping of the connector may separate, or the soldering may be damaged, or the wiring may be broken.

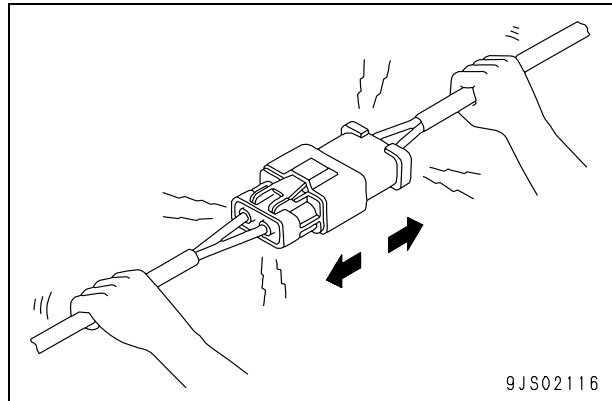

4) High-pressure water entering connector

The connector is designed to make it difficult for water to enter (drip-proof structure), but if high-pressure water is sprayed directly on the connector, water may enter the connector, depending on the direction of the water jet. Accordingly, take care not to splash water over the connector. The connector is designed to prevent water from entering, but at the same time, if water does enter, it is difficult for it to be drained. Therefore, if water should get into the connector, the pins will be short-circuited by the water, so if any water gets in, immediately dry the connector or take other appropriate action before passing electricity through it.

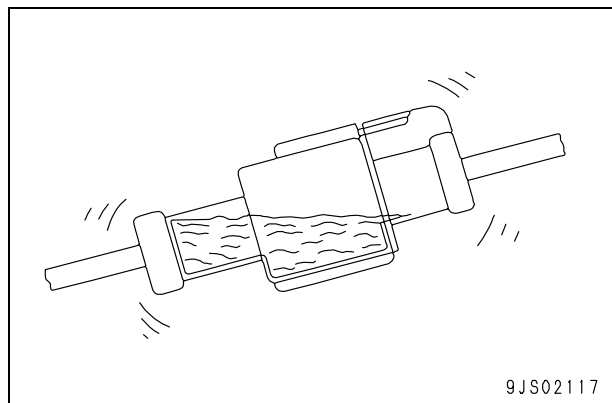

5) Oil or dirt stuck to connector

If oil or grease are stuck to the connector and an oil film is formed on the mating surface between the male and female pins, the oil will not let the electricity pass, so there will be defective contact. If there is oil or grease stuck to the connector, wipe it off with a dry cloth or blow it dry with compressed air and spray it with a contact restorer.

- ★ When wiping the mating portion of the connector, be careful not to use excessive force or deform the pins.
- ★ If there is oil or water in the compressed air, the contacts will become even dirtier, so remove the oil and water from the compressed air completely before cleaning with compressed air.

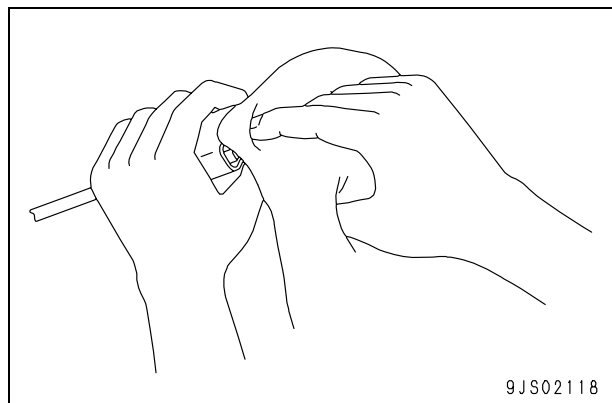

3. Removing, installing, and drying connectors and wiring harnesses

1) Disconnecting connectors

1] Hold the connectors when disconnecting.

When disconnecting the connectors, hold the connectors. For connectors held by a screw, loosen the screw fully, then hold the male and female connectors in each hand and pull apart. For connectors which have a lock stopper, press down the stopper with your thumb and pull the connectors apart.

★ Never pull with one hand.

2] When removing from clips

- Both of the connector and clip have stoppers, which are engaged with each other when the connector is installed.

- When removing a connector from a clip, pull the connector in a parallel direction to the clip for removing stoppers.

★ If the connector is twisted up and down or to the left or right, the housing may break.

3] Action to take after removing connectors

After removing any connector, cover it with a vinyl bag to prevent any dust, dirt, oil, or water from getting in the connector portion.

★ If the machine is left disassembled for a long time, it is particularly easy for improper contact to occur, so always cover the connector.

