

# SHOP MANUAL



# WB97S-2

**BACKHOE-LOADER**

**SERIAL NUMBER**

**WB97S-2 97SF10001 and up**



# CONTENTS

	No. of page
<b>10 STRUCTURE AND FUNCTION .....</b>	<b>10-1</b>
<b>20 TESTING AND ADJUSTING.....</b>	<b>20-1</b>
<b>30 DISASSEMBLY AND ASSEMBLY.....</b>	<b>30-1</b>
<b>40 MAINTENANCE STANDARD .....</b>	<b>40-1</b>

PAGE INTENTIONALLY LEFT BLANK

The affected pages are indicated by the use of the following marks. It is requested that necessary actions be taken to these pages according to table below.

Mark	Indication	Action required
○	Page to be newly	Add
●	Page to be replaced	Replace
( )	Page to be delete	Discard

Pages having no marks are those previously revised or made additions.

### LIST OF REVISED PAGES



Mark	Page	Time of revision	Mark	Page	Time of revision	Mark	Page	Time of revision	Mark	Page	Time of revision	Mark	Page	Time of revision
	00-1			10-25			10-66			20-8			20-49	
	00-2			10-26			10-67			20-9			20-50	
	00-3			10-27			10-68			20-10			20-51	
	00-4			10-28			10-69			20-11			20-52	
	00-5			10-29			10-70			20-12			20-53	
	00-6			10-30			10-71			20-13			20-54	
	00-7			10-31			10-72			20-14			20-55	
	00-8			10-32			10-73			20-15			20-56	
	00-9			10-33			10-74			20-16				
	00-10			10-34			10-75			20-17			30-1	
	00-11			10-35			10-76			20-18			30-2	
	00-12			10-36			10-77			20-19			30-3	
	00-13			10-37			10-78			20-20			30-4	
	00-14			10-38			10-79			20-21			30-5	
	00-15			10-39			10-80			20-22			30-6	
	00-16			10-40			10-81			20-23			30-7	
				10-41			10-82			20-24			30-8	
	10-1			10-42			10-83			20-25			30-9	
	10-2			10-43			10-84			20-26			30-10	
	10-3			10-44			10-85			20-27			30-11	
	10-4			10-45			10-86			20-28			30-12	
	10-5			10-46			10-87			20-29			30-13	
	10-6			10-47			10-88			20-30			30-14	
	10-7			10-48			10-89			20-31			30-15	
	10-8			10-49			10-90			20-32			30-16	
	10-9			10-50			10-91			20-33			30-17	
	10-10			10-51			10-92			20-34			30-18	
	10-11			10-52			10-93			20-35			30-19	
	10-12			10-53			10-94			20-36			30-20	
	10-13			10-54			10-95			20-37			30-21	
	10-14			10-55			10-96			20-38			30-22	
	10-15			10-56			10-97			20-39			30-23	
	10-16			10-57			10-98			20-40			30-24	
	10-17			10-58						20-41			30-25	
	10-18			10-59			20-1			20-42			30-26	
	10-19			10-60			20-2			20-43			30-27	
	10-20			10-61			20-3			20-44			30-28	
	10-21			10-62			20-4			20-45			30-29	
	10-22			10-63			20-5			20-46			30-30	
	10-23			10-64			20-6			20-47			30-31	
	10-24			10-65			20-7			20-48			30-32	

Mark	Page	Time of revision	Mark	Page	Time of revision	Mark	Page	Time of revision	Mark	Page	Time of revision	Mark	Page	Time of revision
	30-33			30-90			40-44							
	30-34			30-91										
	30-35			30-92										
	30-36			30-93										
	30-37			30-94										
	30-38			30-95										
	30-39			30-96										
	30-40			30-97										
	30-41			30-98										
	30-42			30-99										
	30-43			30-100										
	30-44			30-101										
	30-45			30-102										
	30-46													
	30-47			40-1										
	30-48			40-2										
	30-49			40-3										
	30-50			40-4										
	30-51			40-5										
	30-52			40-6										
	30-53			40-7										
	30-54			40-8										
	30-55			40-9										
	30-56			40-10										
	30-57			40-11										
	30-58			40-12										
	30-59			40-13										
	30-60			40-14										
	30-61			40-15										
	30-62			40-16										
	30-63			40-17										
	30-64			40-18										
	30-65			40-19										
	30-66			40-20										
	30-67			40-21										
	30-68			40-22										
	30-69			40-23										
	30-70			40-24										
	30-71			40-25										
	30-72			40-26										
	30-73			40-27										
	30-74			40-28										
	30-75			40-29										
	30-76			40-30										
	30-77			40-31										
	30-78			40-32										
	30-79			40-33										
	30-80			40-34										
	30-81			40-35										
	30-82			40-36										
	30-83			40-37										
	30-84			40-38										
	30-85			40-39										
	30-86			40-40										
	30-87			40-41										
	30-88			40-42										
	30-89			40-43										



## IMPORTANT SAFETY NOTICE

Proper service and repair is extremely important for the safe operation of your machine. The service and repair techniques recommended by Komatsu Utility and describe in this manual are both effective and safe methods of operation. Some of these operations require the use of tools specially designed by Komatsu Utility for the purpose.

To prevent injury to workers, the symbols  and  are used to mark safety precautions in this manual. The cautions accompanying these symbols should always be carefully followed. If any danger arises or may possibly arise, first consider safety, and take necessary steps to face.



## SAFETY

### GENERAL PRECAUTIONS

Mistakes in operation extremely dangerous. Read all the Operation and Maintenance Manual carefully BEFORE operating the machine.

1. Before carrying out any greasing or repairs, read all the precautions written on the decals which are stuck on the machine.
2. When carrying out any operation, always wear safety shoes and helmet. Do not wear loose work clothes, or clothes with buttons missing.
  - Always wear safety glasses when hitting parts with a hammer.
  - Always wear safety glasses when grinding parts with a grinder, etc.
3. If welding repairs are needed, always have a trained, experienced welder carry out the work. When carrying out welding work, always wear welding gloves, apron, glasses, cap and other clothes suited for welding work.
4. When carrying out any operation with two or more workers, always agree on the operating procedure before starting. Always inform your fellow workers before starting any step of the operation. Before starting work, hang UNDER REPAIR signs on the controls in the operator's compartment.
5. Keep all tools in good condition and learn the correct way to use them.
6. Decide a place in the repair workshop to keep tools and removed parts. Always keep the tools and parts in their correct places. Always keep the work area clean and make sure that there is no dirt or oil on the floor. Smoke only in the areas provided for smoking. Never smoke while working.

### PREPARATIONS FOR WORK

7. Before adding or making any repairs, park the machine on hard, level ground, and block the wheels to prevent the machine from moving.
8. Before starting work, lower outrigger, bucket or any other work equipment to the ground. If this is not possible, use blocks to prevent the work equipment from falling down. In addition, be sure to lock all the control levers and hang warning sign on them.
9. When disassembling or assembling, support the machine with blocks, jacks or stands before starting work.
10. Remove all mud and oil from the steps or other places used to get on and off the machine. Always use the handrails, ladders or steps when getting on or off the machine. Never jump on or off the machine. If it is impossible to use the handrails, ladders or steps, use a stand to provide safe footing.

### PRECAUTIONS DURING WORK

11. When removing the oil filler cap, drain plug or hydraulic pressure measuring plugs, loosen them slowly to prevent the oil from spurting out. Before disconnecting or removing components of the hydraulic circuit and engine cooling circuit, first remove the pressure completely from the circuit.
12. The water and oil in the circuits are not hot when the engine is stopped, so be careful not to get burned. Wait for the oil water to cool before carrying out any work on the cooling water circuits.

13. Before starting work, remove the leads from the battery. Always remove the lead from the negative ( – ) terminal first.
14. When raising heavy components, use a hoist or crane. Check that the wire rope, chains and hooks are free from damage.  
Always use lifting equipment which has ample capacity. Install the lifting equipment at the correct places.  
Use a hoist or crane and operate slowly to prevent the component from hitting any other part.  
Do not work with any part still raised by the hoist or crane.
15. When removing covers which are under internal pressure or under pressure from a spring, always leave two bolts in position on opposite sides. Slowly release the pressure, then slowly loosen the bolts to remove.
16. When removing components, be careful not to break or damage the wiring.  
Damage wiring may cause electrical fires.
17. When removing piping, stop the fuel or oil from spilling out. If any fuel or oil drips on to the floor, wipe it up immediately.  
Fuel or oil on the floor can cause you to slip, or can even start fires.
18. As a general rule, do not use gasoline to wash parts. In particular, use only the minimum of gasoline when washing electrical parts.
19. Be sure to assemble all parts again in their original places. Replace any damage parts with new parts.
  - When installing hoses and wires, be sure that they will not be damaged by contact with other parts when the machine is being operated.
20. When installing high pressure hoses, make sure that they are not twisted. Damaged tubes are dangerous, so be extremely careful when installing tubes for high pressure circuits. Also, check that connecting parts are correctly tightened.
21. When assembling or installing parts, always use specified tightening torques.  
When installing the parts which vibrate violently or rotate at high speed, be particularly careful to check that they are correctly installed.
22. When aligning two holes, never insert your fingers or hand.
23. When measuring hydraulic pressure, check that the measuring tool is correctly assembled before taking any measurement.
24. Take care when removing or installing tracks of in particular rubber tracks. When removing the track, the track separates suddenly, so never let anyone stand at either end of the wheel.

---

## FOREWORD

---

This shop manual has been prepared as an aid to improve the quality of repairs by giving the operator an accurate understanding of the product and by showing him the correct way to perform repairs and make judgements. Make sure you understand the contents of this manual and use it to full effect at every opportunity.

This shop manual mainly contains the necessary technical information for operations performed in a service workshop.

The manual is divided into chapters on each main group of components; these chapters are further divided into the following sections.

### **STRUCTURE AND FUNCTION**

This section explains the structure and function of each component. It serves not only to give an understanding of the structure, but also serves as reference material for troubleshooting.

### **TESTING AND ADJUSTING**

This section explains checks to be made before and after performing repairs, as well as adjustments to be made at completion of the checks and repairs.

Troubleshooting charts correlating «Problems» to «Causes» are also included in this section.

### **DISASSEMBLY AND ASSEMBLY**

This section explains the order to be followed when removing, installing, disassembling or assembling each component, as well as precautions to be taken for these operations.

### **MAINTENANCE STANDARD**

This section gives the judgement standards when inspecting disassembled parts.

### **NOTICE**

**The specifications contained in this shop manual are subject to change at any time and without any notice.**

**Contact your Komatsu Utility distributor for the latest information.**



## HOW TO READ THE SHOP MANUAL

### VOLUMES

Shop manual are issued as a guide to carry out repairs. These various volumes are designed to avoid duplicating the same information.

### DISTRIBUTION AND UPDATING

Any additions, amendments or other changes will be sent to Komatsu Utility distributors. Get the most up-to-date information before you start any work.

### FILING METHOD

1. See the page number on the bottom of the page. File the pages in correct order.
2. Following examples show you how to read the page number.

Example

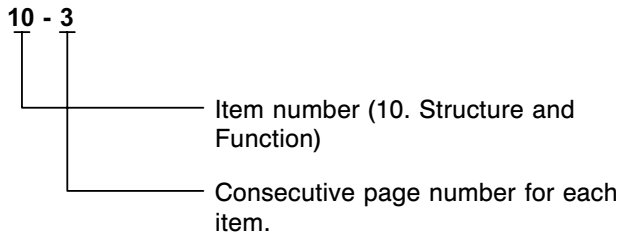

3. Additional pages: additional pages are indicated by a hyphen (-) and number after the page number.

File as in the example.

Example:

- 10-4
- 10-4-1
- 10-4-2 ] Added pages
- 10-5

### REVISED EDITION MARK

(① ② ③ ....)

When a manual is revised, an edition mark is recorded on the bottom outside corner of the pages.

### REVISIONS

Revised pages are shown on the LIST OF REVISED PAGES between the title page and SAFETY page.

### SYMBOLS

In order to make the shop manual greatly helpful, important points about safety and quality are marked with the following symbols.

Symbol	Item	Remarks
	Safety	Special safety precautions are necessary when performing the work.
		Extra special safety precautions are necessary when performing the work because it is under internal pressure.
	Caution	Special technical precautions or other precautions for preserving standards are necessary when performing the work.
	Weight	Weight of parts or systems. Caution necessary when selecting hoisting wire, or when working posture is important, etc.
	Tightening torque	Parts that require special attention for the tightening torque during assembly.
	Coat	Parts to be coated with adhesives and lubricants etc.
	Oil, water	Places where oil, water or fuel must be added, and their quantity.
	Drain	Places where oil or water must be drained, and quantity to be drained.

# HOISTING INSTRUCTIONS

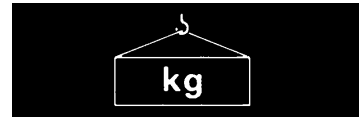

**⚠** Heavy parts (25 kg or more) must be lifted with a hoist etc. In the **Disassembly and Assembly** section, every part weighing 25 kg or more is clearly indicated with the symbol 

- If a part cannot be smoothly removed from the machine by hoisting, the following checks should be made:
  - Check for removal of all bolts fastening the part to the relative parts.
  - Check for any part causing interference with the part to be removed.

## 2. Wire ropes

- Use adequate ropes depending on the weight of parts to be hoisted, referring to the table below:

WIRE ROPES (Standard «S» or «Z» twist ropes without galvanizing)	
Rope diameter (mm)	Allowable load (tons)
10	1.0
11.2	1.4
12.5	1.6
14	2.2
16	2.8
18	3.6
20	4.4
22.4	5.6
30	10.0
40	18.0
50	28.0
60	40.0

The allowable load value is estimated to be one-sixth or one-seventh of the breaking strength of the rope used.

- Sling wire ropes from the middle portion of the hook. Slinging near the edge of the hook may cause the rope to slip off the hook during hoist-

ing, and a serious accident can result. Hooks have maximum strength at the middle portion.

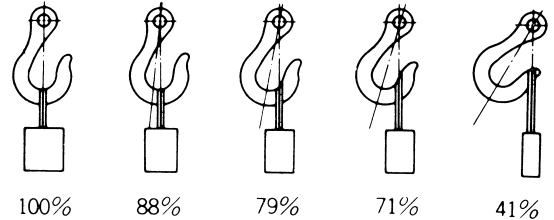

- Do not sling a heavy load with one rope alone, but sling with two or more ropes symmetrically wound on to the load.
  - ⚠** Slinging with one rope may cause turning of the load during hoisting, untwisting of the rope, or slipping of the rope from its original winding position on the load, which can cause dangerous accidents.

- Do not sling a heavy load with ropes forming a wide hanging angle from the hook. When hoisting a load with two or more ropes, the force subjected to each rope will increase with the hanging angles. The table below shows the variation of allowable load (kg) when hoisting is made with two ropes, each of which is allowed to sling up to 1000 kg vertically, at various hanging angles. When two ropes sling a load vertically, up to 2000 kg of total weight can be suspended. This weight becomes 1000 kg when two ropes make a 120° hanging angle. On the other hand, two ropes are subjected to an excessive force as large as 4000 kg if they sling a 2000 kg load at a lifting angle of 150°.

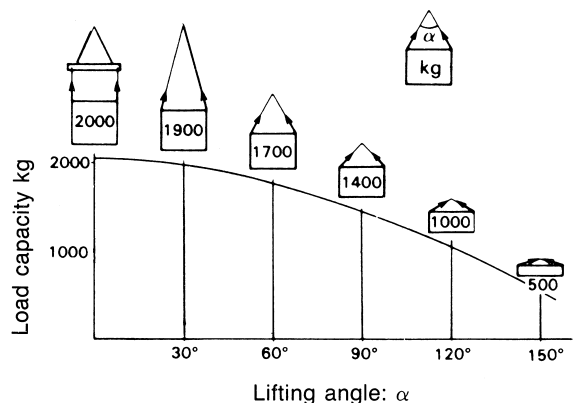



## STANDARD TIGHTENING TORQUE



## STANDARD TIGHTENING TORQUE

The following charts give the standard tightening torques of bolts and nuts. Exceptions are given in sections of «Disassembly and Assembly».

### 1. STANDARD TIGHTENING TORQUE OF BOLTS AND NUT

Thread diameter of bolts (mm)	Pitch of bolts (mm)	Width across flat (mm)		8.8		10.9	
				kgm	Nm	kgm	Nm
		6	1	10	5	0.96±0.1	9.5±1
8	1.25	13	6	2.3±0.2	23±2	3.2±0.3	32.2±3.5
10	1.5	17	8	4.6±0.5	45±4.9	6.5±0.6	63±6.5
12	1.75	19	10	7.8±0.8	77±8	11±1	108±11
14	2	22	12	12.5±1	122±13	17.5±2	172±18
16	2	24	14	19.5±2	191±21	27±3	268±29
18	2.5	27	14	27±3	262±28	37±4	366±36
20	2.5	30	17	38±4	372±40	53±6	524±57
22	2.5	32	17	52±6	511±57	73±8	719±80
24	3	36	19	66±7	644±70	92±10	905±98
27	3	41	19	96±10	945±100	135±15	1329±140
30	3.5	46	22	131±14	1287±140	184±20	1810±190
33	3.5	50	24	177±20	1740±200	250±27	2455±270
36	4	55	27	230±25	2250±250	320±35	3150±350
39	4	60	—	295±33	2900±330	410±45	4050±450

This torque table does not apply to bolts or nuts which have to fasten nylon or other parts non-ferrous metal washer.

★ Nm (Newton meter): 1 Nm = 0.102 kgm

## STANDARD TIGHTENING TORQUE

### 2. TIGHTENING TORQUE FOR NUTS OF FLARED

Use these torques for nut part of flared.

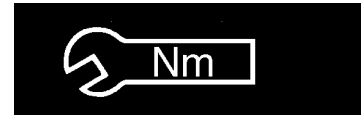
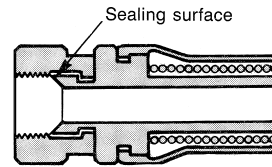

Thread diameter of nut part (mm)	Width across flats of nut part (mm)	TIGHTENING TORQUE	
		kgm	Nm
1/2" - 20	17	2.6±0.5	25.5±4.9
9/16" - 18	17	4±0.5	39.2±4.9
3/4" - 16	22	6.7±2	65.7±19.6
7/8" - 14	27	8±2	78.5±19.6
1.1/16" - 12	32	9.7±3	95.15±29.4
1.5/16" - 12	38	17±3	166.7±29.4
1.5/8" - 12	50	20±5	196.2±49
22	27	8±2	78.5±19.6
33	41	20±5	196.2±49

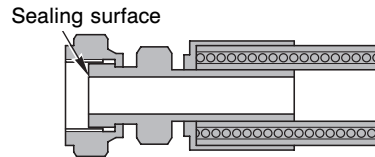

Thread diameter of nut part (mm)	Width across flats of nut part (mm)	TIGHTENING TORQUE	
		kgm	Nm
9/16" - 18	17	2.3 - 2.5	23 - 25
11/16" - 16	22	3.4 - 3.9	33 - 38
13/16" - 16	24	5.2 - 5.8	51 - 57
1" - 14	30	8.2 - 9.2	80 - 90
1.3/16" - 12	36	12.2 - 13.3	120 - 130
1.7/16" - 12	41	15.3 - 17.3	150 - 170
1.11/16" - 12	50	18.4 - 20.4	180 - 200
2" - 12	57	20.4 - 24.4	200 - 240



## COATING MATERIALS

The recommended coating materials prescribed in Komatsu Utility Shop Manuals are listed below:

Nomenclature	Code	Applications
Adhesives	ASL800010	Used to apply rubber pads, rubber gaskets and cork plugs.
	ASL800020	Used to apply resin, rubber, metallic and non-metallic parts when a fast, strong seal is needed.
	Loctite 222	Used for low resistance locking of screws, check nuts and adjustment nuts.
	Loctite 242	To prevent the loosening of bolts, nuts and plugs and the leakage of oil. Used for medium resistance locking of screws and nuts of every type, and for locking keys and bearings.
	Loctite 262	Used for high resistant of threaded parts that can be removed with normal tools.
	Loctite 270	Used for high resistant locking and for sealing threaded parts, bolts and stud bolts.
	Loctite 542	Used for sealing the union threads for hydraulic tubes.
	Loctite 573	Used for sealing rather exact plane surfaces when the option of possible future dismantling is required.
	Loctite 601	Used for high resistant locking of mechanical components that can be removed only after heating
	Loctite 675	Used to lock cylindrical couplings and for the permanent locking of threaded parts, and also to lock shafts to bearings, gears, pulleys, pins, bushings, etc.
Gasket sealant	ASL800060	Used by itself to seal grease fittings, tapered screw fittings and tapered screw fittings in hydraulic circuits of less than 50 mm in diameter.
	Loctite 510	Used by itself on mounting flat surface (Clearance between surfaces within 0.2 mm)
	Loctite 518	Used by itself on mounting flat surface (Clearance between surfaces within 0.5 mm)
Antifriction compound (Lubricant including Molybdenum disulfide)	ASL800040	Applied to bearings and taper shaft to facilitate press-fitting and to prevent sticking, burning or rusting.
Grease (Lithium grease)	ASL800050	Applied to bearings, sliding parts and oil seals for lubrication, rust prevention and facilitation of assembling work.
Vaseline	-	Used for protecting battery electrode terminals from corrosion.

## ELECTRIC WIRE CODE

In the wiring diagrams various colours and symbols are employed to indicate the thickness of wires.

This wire code table will help you understand WIRING DIAGRAMS.

Example: R -N 1.5 indicates a cable having a nominal number 1.5 and red coating with black stripe.

## CLASSIFICATION BY THICKNESS

Nominal number	Copper wire			Cable O.D. (mm)	Current rating (A)
	Number strands	∅ of strands (mm)	Cross section (mm <sup>2</sup> )		
1	14	0.30	0.99	2.80	11
1.5	21	0.30	1.48	3.32	14
2.5	35	0.30	2.47	3.80	20
4	56	0.30	3.95	4.60	28
6	84	0.30	5.93	5.20	37
10	84	0.40	10.55	7.10	53
50	399	0.40	50.11	14.00	160

## CLASSIFICATION BY COLOUR AND CODE

Code	Primary	Auxiliary									
		A-B	-	A-G	-	A-N	A/N	A-R	A/R	A-V	A/V
Code	A	A-B	-	A-G	-	A-N	A/N	A-R	A/R	A-V	A/V
Colour	Light blue	Light blue - White		Light blue - Yellow		Light blue - Black		Light blue - Red		Light blue - Green	
Code	B	B-G	-	B-N	B/N	B-R	B/R	-	B/V	-	-
Colour	White	White - Yellow		White - Black		White - Red		White - Green		-	-
Code	C	C-B	C/B	C-L	-	C-N	-	-	-	-	-
Colour	Orange	Orange - White		Orange - Blue		Orange - Black		-		-	-
Code	G	G-N	G/N	G-R	-	G-V	-	-	-	-	-
Colour	Yellow	Yellow - Black		Yellow - Red		Yellow - Green		-		-	-
Code	H	H-L	-	H-N	H/N	H-R	-	-	-	-	-
Colour	Gray	Gray - Blue		Gray - Black		Gray - Pink		-		-	-
Code	L	L-B	L/B	-	L/N	L-G	-	-	-	-	-
Colour	Blue	Blue - White		Blue - Black		Blue - Yellow		-		-	-
Code	M	M-B	-	M-N	M/N	M-V	-	-	-	-	-
Colour	Brown	Brown - White		Brown - Black		Brown - Green		-		-	-
Code	N	-	-	-	-	-	-	-	-	-	-
Colour	Black	-		-		-		-		-	-
Code	R	R-G	-	R-N	R/N	R-V	-	-	-	-	-
Colour	Red	Red - Yellow		Red - Black		Red - Green		-		-	-
Code	S	S-N	-	S-G	-	-	-	-	-	-	-
Colour	Pink	Pink - Black		Pink - Yellow		-		-		-	-
Code	V	V-B	-	V-N	V/N	-	-	-	-	-	-
Colour	Green	Green - White		Green - Black		-		-		-	-
Code	Z	Z-B	Z/B	Z-N	Z/N	-	-	-	-	-	-
Colour	Violet	Violet - White		Violet - Black		-		-		-	-

## COMPOSITION OF THE COLOURS

The coloration of two-colour wires is indicated by the composition of the symbols listed.

Example: G-V = Yellow-Green with longitudinal colouring.

G/V = Yellow-Green with transversal colouring.

## WEIGHT TABLE

 This weight table is a guide for use when transporting or handling components.

Unit: kg

Machine model	WB97S-2
From serial no.	97SF10001-
Engine assembly - Muffler - Exhaust pipe	410
Radiator - exchanger	37
Hydraulic tank (without hydraulic oil)	77
Fuel tank (without fuel)	73
Front counterweight	300
Engine hood	27
Cab (without seat)	595
Seat	34
Engine - gear-box - pump group	740
Piston pump	38
Transmission	230
Front axle	530
Rear axle	540
Front wheel	163
Rear wheel	163
2-spool control valve	24
3-spool control valve	30
Front work equipment assy.:	960
• Boom	370
• Shovel	427
• Fulcrum lever	13x4
• Tilt lever	48x2
• Raise cylinder	40x2
• Tilt cylinder	45x2
<b>Backhoe</b>	
Work equipment assy.:	
• with standard arm	850
• with long arm	885
• with jig arm	1030
Boom	323
Arm	213
Long arm	245
Boom swing bracket	133
Backframe	237
6-spool control valve	47
7-spool control valve	53
8-spool control valve	59
Jig arm	392
Outriggers	57
Boom cylinder	78
Arm cylinder	69
Bucket cylinder	49
Outrigger cylinder	42
Swing cylinder	30
Standard bucket	156

## TABLE OF OIL AND COOLANT QUANTITIES

RESERVOIR	KIND OF FLUID	AMBIENT TEMPERATURE						CAPACITY (ℓ)	
		-20	-10	0	10	20	30°C	Specified	Refill
Crankcase sump	OIL • API CD	SAE 10W						8.6	8.6
		SAE 20W-20							
		SAE 30							
		SAE 40							
		SAE 10W-30							
Hydraulic circuit	OIL • API CD	SAE 10W-30						150	92
Front axle • differential	OIL • UTTO FLUID							10.5	10.5
• final red. gear (each)								1.3	1.3
Rear axle: • differential								9	9
• final red. gear (each)								1.3	1.3
Hydraulic transmission	OIL • GM DEXRON® II D (DEXRON® is a registered trademark of General Motors Corporation)							19	16
Braking system								0.8	0.8
Fuel tank	DIESEL OIL	*						130	—
Engine coolant system	WATER + ANTI-FREEZE	ASTM D975 N. 2						18	—
	WATER							18	—
	PERMANENT LIQUID							18	—

\* ASTM D975 N. 1

ASTM: America Society of Testing and Materials  
 SAE: Society of Automotive Engineers  
 API: American Petroleum Institute  
 MIL: USA Military Specification  
 CCMC: Common Market Constructors Committe

**First filling quantity:** total quantity of oil, including the oil for the components and pipes.

**Oil change quantity:** quantity of oil necessary to fill the system or unit during the normal inspection and maintenance operations.



**NOTE:**

- (1) When the diesel oil sulphur content is less than 0.5%, change the engine oil according to the periodic maintenance intervals indicated in the operation and maintenance manual. In the diesel oil sulphur content exceeds 0.5% change the engine oil according to the following table:

<b>Sulphur content</b>	<b>Engine oil change interval</b>
from 0.5 to 1.0%	1/2 of regular interval
over 1.0%	1/4 of regular interval

- (2) When starting the engine at temperatures below 0 °C, use engine oil SAE 10W, 20W-20 and 10W-30, even if during the day the temperature increases by 10 °C.
- (3) Use engine oil with CD classification; if oil with CD classification is used, reduce the engine oil change interval by a half.
- (4) Use original products, which have characteristics specifically formulated and approved for the engine, the hydraulic circuit of equipment and for reductions.

---

# 10 STRUCTURE AND FUNCTION

---

Power train .....	2	Safety valve.....	75
Transmission .....	4	Brake pump.....	77
Drive shafts.....	8	Shovel cylinders.....	78
Control valve block.....	10	Backhoe cylinders.....	79
Front axle .....	12	Air-conditioning unit.....	83
Rear axle .....	15	How the air-conditioning unit functions.....	84
Steering system (4WS) .....	19	Electrical circuit diagram (1/7).....	85
Steering unit.....	23	Electrical circuit diagram (2/7).....	87
Hydraulic pump .....	24	Electrical circuit diagram (3/7).....	89
Hydraulic circuit .....	45	Electrical circuit diagram (4/7).....	91
Shovel control valve .....	46	Electrical circuit diagram (5/7).....	93
Backhoe control valve .....	52	Electrical circuit diagram (6/7).....	95
CLSS.....	59	Electrical circuit diagram (7/7).....	97
Solenoid valve.....	73		

# POWER TRAIN

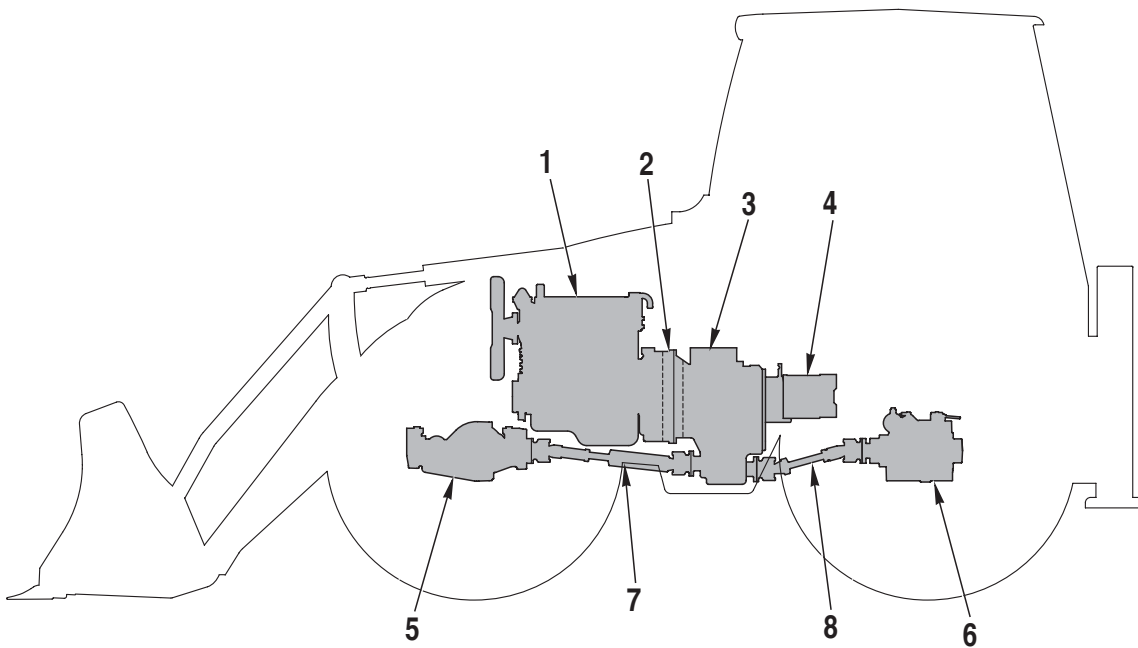

RKZ04450

## DESCRIPTION

- The driving power for the engine (1) is transmitted through the flywheel to the converter (2). The converter (2) uses hydraulic oil to convert the torque transmitted by the engine (1) into driving power. The converter (2) transmits motion to the drive shaft of the transmission (3) and to the drive shaft of the hydraulic pump (4).
- The transmission (3) has two hydraulically-activated clutches that can be selected by an electrical-controlled gear selector. It also has manual gear selection (four forward gears and four reverse gears).
- The driving power is transmitted from the transmission flanges (3) to the front (5) and rear (6) axles through the Cardan drive shafts (7 and 8).
- The driving power transmitted to the front (5) and rear (6) axles is reduced by the differentials and then transmitted to the planetary gear through the differential shafts.

Gears	Transmission	Differential	Planetary	Total
1 <sup>st</sup> gear	4.374	2.75	6.923	83.273
2 <sup>nd</sup> gear	2.436			46.377
3 <sup>rd</sup> gear	1.232			23.455
4 <sup>th</sup> gear	0.651			12.394

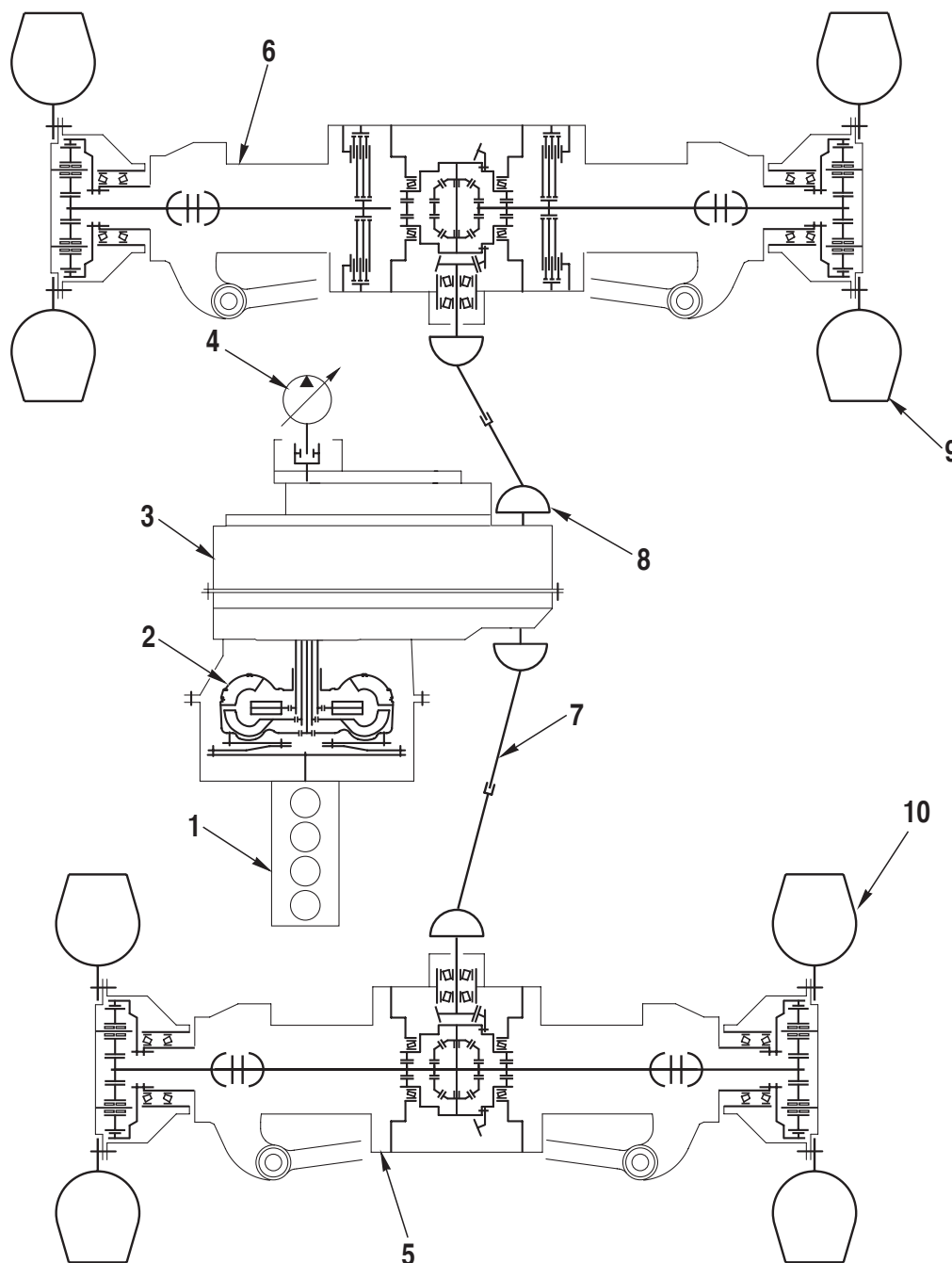

RIKZ04460

- |                   |                             |                  |
|-------------------|-----------------------------|------------------|
| 1. Diesel engine  | 5. Front axle               | 9. Rear wheels   |
| 2. Converter      | 6. Rear axle                | 10. Front wheels |
| 3. Transmission   | 7. Front Cardan drive shaft |                  |
| 4. Hydraulic pump | 8. Rear Cardan drive shaft  |                  |