

624H Loader and TC62H Tool Carrier

OPERATOR'S MANUAL 624H Loader and TC62H Tool Carrier

OMT195360 Issue B3 (ENGLISH)

CALIFORNIA
Proposition 65 Warning

Diesel engine exhaust and some of its constituents are known to the State of California to cause cancer, birth defects, and other reproductive harm.

If this product contains a gasoline engine:

 **WARNING**

The engine exhaust from this product contains chemicals known to the State of California to cause cancer, birth defects or other reproductive harm.

The State of California requires the above two warnings.

**Worldwide Construction
And Forestry Division**
(This manual replaces OMT180472 G0)
LITHO IN U.S.A.

Introduction

Foreword

READ THIS MANUAL carefully to learn how to operate and service your machine correctly. Failure to do so could result in personal injury or equipment damage. This manual and safety signs on your machine may also be available in other languages. (See your John Deere dealer to order.)

THIS MANUAL SHOULD BE CONSIDERED a permanent part of your machine and should remain with the machine when you sell it.

MEASUREMENTS in this manual are given in both metric and customary U.S. unit equivalents. Use only correct replacement parts and fasteners. Metric and inch fasteners may require a specific metric or inch wrench.

RIGHT-HAND AND LEFT-HAND sides are determined by facing in the direction of forward travel.

WRITE PRODUCT IDENTIFICATION NUMBERS (P.I.N.) in the Machine Numbers section. Accurately record all the numbers to help in tracing the machine should it be stolen. Your dealer also needs these

numbers when you order parts. File the identification numbers in a secure place off the machine.

WARRANTY is provided as part of John Deere's support program for customers who operate and maintain their equipment as described in this manual. The warranty is explained on the warranty certificate which you should have received from your dealer.

This warranty provides you the assurance that John Deere will back its products where defects appear within the warranty period. In some circumstances, John Deere also provides field improvements, often without charge to the customer, even if the product is out of warranty. Should the equipment be abused, or modified to change its performance beyond the original factory specifications, the warranty will become void and field improvements may be denied. Setting fuel delivery above specifications or otherwise overpowering machines will result in such action.

THE TIRE MANUFACTURER'S warranty supplied with your machine may not apply outside the U.S.

DX,IFC7 -19-16NOV01-1/1

Emission Control Statement

EMISSIONS CONTROL WARRANTY STATEMENT FOR NEW JOHN DEERE CONSTRUCTION EQUIPMENT (U.S. AND CANADA)

To determine if the engine in your machine qualifies for the additional warranties set forth below, look for the "Engine Information" label located on your engine. If you reside in the United States and the engine label states: "Engine conforms to US EPA regulations on heavy duty non road diesel cycle engines," you are entitled to the "U.S. Emission Control Warranty Statement." If you reside in California, and the engine label states: "Engine conforms to California regulations on heavy duty non road diesel cycle engines," you are entitled to the "California Emission Control Warranty Statement."

U.S. EPA EMISSIONS CONTROL WARRANTY STATEMENT

Emissions control-related parts and components are warranted by John Deere for five years or 3000 hours of operation, whichever occurs first. John Deere further warrants that the engine covered by this warranty was designed, built, and equipped so as to conform at the time of sale with all U.S. emissions standards at the time of manufacture, and that it is free of defects in materials and workmanship which would cause it not to meet these standards within the period of five years or 3000 hours of operations, whichever occurs first.

Warranties stated on this certificate refer only to emissions-related parts and components of your engine. The complete machine warranty, less emissions-related parts and components, is provided separately as "John Deere "Secure Warranty" For New Construction Products."

CALIFORNIA EMISSION CONTROL WARRANTY STATEMENT YOUR WARRANTY RIGHTS AND OBLIGATIONS

The California Air Resources Board (CARB) and John Deere are pleased to explain the emission control system on your new engine. In California, new heavy-duty engines must be designed, built and equipped to meet the State's stringent anti-smog standards. John Deere must warrant the emission control system on your engine for the periods of time listed below provided there has been no abuse, neglect, or improper maintenance of your machine.

Your emissions control system includes:

- Fuel Metering System
 - Fuel Injection System
- Air Induction System
 - Intake Manifold
 - Turbocharger System
 - Charge Air Cooling System
- Miscellaneous Items used in Above Systems

Where a warrantable condition exists, i.e. failure due to defect in John Deere-supplied material and/or workmanship, John Deere will repair your heavy-duty engine at no cost to you including diagnosis, parts and labor

JOHN DEERE'S WARRANTY COVERAGE:

The emission control system of your heavy-duty engine is warranted for five years or 3000 hours of operation, whichever occurs first. If any emission-related part on your engine is defective, the part will be repaired or replaced by John Deere. Warranties stated on this certificate refer only to emissions-related parts and components of your engine. The complete machine warranty, less emissions-related parts and components, is provided separately as the "John Deere "Secure Warranty" For New Construction Products."

OWNER'S WARRANTY RESPONSIBILITIES:

As the heavy-duty engine owner, you are responsible for the performance of the required maintenance as outlined in the

Operator's Manual. John Deere recommends that you retain all receipts covering maintenance on your heavy-duty engine, but John Deere cannot deny warranty solely for the lack of receipts or for your failure to ensure the performance of all scheduled maintenance.

However, as the heavy-duty engine owner, you should be aware that John Deere may deny you warranty coverage if your heavy-duty engine or a part has failed due to abuse, neglect, improper maintenance or unapproved modifications.

Your engine is designed to operate on diesel fuel only. Use of any other fuel may result in your engine no longer operating in compliance with California's emissions requirements.

You are responsible for initiating the warranty process. The CARB suggests that you present your machine to the nearest authorized John Deere dealer as soon as a problem is suspected. The warranty repairs should be completed by the service dealer as expeditiously as possible.

If you have any questions regarding your warranty rights and responsibilities, you should contact John Deere at 1-319-292-5400, or the State of California Air Resources Board, Mobile Source Operation Division, PO Box 8001, El Monte, CA 91731-2900

The warranty period begins on the date the machine is delivered to an ultimate purchaser, or when otherwise put into service. John Deere warrants to the ultimate purchaser and each subsequent purchaser that the engine is designed, built and equipped so as to conform with all applicable regulations adopted by the Air Resources Board, and that it is free from defects in materials and workmanship which would cause the failure of a warranted part.

Any warranted part which is scheduled for replacement as required maintenance by the operator's manual is warranted by John Deere for the period of time prior to the first scheduled replacement point for that part. If the part fails prior to the first scheduled replacement point, the part shall be repaired or replaced under warranty. Any such part repaired or replaced under warranty is warranted for the remainder of the period prior to the first scheduled replacement point for that part.

Any warranted part which is not scheduled for replacement as required maintenance, or which is scheduled only for regular inspection to the effect of repairing or replacing as necessary, is warranted for the warranty period.

Repair or replacement of a warranted part will be performed at no charge to you by an authorized John Deere dealer. You will not be charged for diagnostic labor which leads to the determination that a warranted part is defective, if the diagnostic work is performed by a John Deere dealer.

John Deere is liable for damages to other engine components caused by failure under warranty of any warranted part.

John Deere is NOT liable for travel or mileage on extended emissions warranty service calls.

Any replacement part may be used in the performance of any maintenance or repairs, and such use will not reduce the warranty obligations of John Deere. However, the use of add-on or modified parts are grounds for disallowing a warranty claim.

Technical Information Feedback Form

We need your help to continually improve our technical publications. Please copy this page and FAX or mail your comments, ideas and improvements.

SEND TO: John Deere Dubuque Works
P.O. Box 538
Attn: Publications Supervisor, Dept. 303
Dubuque, IA 52004-0538

FAX NUMBER: 563-589-5800

Ideas, Comments (Please State Page Number): _____

OVERALL, how would you rate the quality of this publication? (Check one)

	Poor		Fair		Good		Very Good		Excellent
1	2	3	4	5	6	7	8	9	10

Company Name: _____
Technician Name: _____
Address: _____
Phone: _____
Fax No.: _____
Dealer Acct. No.: _____

THANK YOU!

Contents

	Page		Page
Safety—Safety Features		Operation—Operator's Station	
Safety Features	1-1-1	Levers	2-1-1
Safety—General Precautions		Pedals	2-1-2
Recognize Safety Information	1-2-1	Deluxe Monitor Panel (Earlier Machines)	2-1-3
Follow Safety Instructions	1-2-1	Deluxe Monitor Panel Functions (Earlier Machines)	2-1-4
Operate Only If Qualified	1-2-1	Deluxe Monitor Panel (Later Machines)	2-1-7
Wear Protective Equipment	1-2-2	Deluxe Monitor Panel Functions (Later Machines)	2-1-8
Avoid Unauthorized Machine Modifications	1-2-2	Console Switches and Accessories (Later Machines—Single Lever Design)	2-1-11
Add Cab Guarding For Special Uses	1-2-2	Console Switch and Accessory Functions (Later Machines—Single Lever Design)	2-1-12
Inspect Machine	1-2-3	Console Switches and Accessories (Later Machines—Two Lever Design)	2-1-14
Stay Clear Of Moving Parts	1-2-3	Console Switch and Accessory Functions (Later Machines—Two Lever Design)	2-1-15
Avoid High-Pressure Fluids	1-2-3	Monitor Display Unit	2-1-17
Beware Of Exhaust Fumes	1-2-4	Monitor Display Unit—Accessory Menu	
Prevent Fires	1-2-4	Normal Display	2-1-18
Prevent Battery Explosions	1-2-4	Clutch Cut-Off (A 01)	2-1-20
Handle Chemical Products Safely	1-2-5	Quick Shift Mode (A 02)	2-1-23
Dispose of Waste Properly	1-2-5	Auto Mode to First (A 03)	2-1-25
Prepare for Emergencies	1-2-5	Job Timer Mode (A 04)	2-1-26
Safety—Operating Precautions		Stop Watch Mode (A 05)	2-1-26
Use Steps And Handholds Correctly	1-3-1	0.1 Hour Meter Mode (A 06)	2-1-27
Start Only From Operator's Seat	1-3-1	Metric Units Mode (A 07)	2-1-27
Use And Maintain Seat Belt	1-3-1	Monitor Display Unit—User Diagnostics Menu	
Prevent Unintended Machine Movement	1-3-2	Service Codes (d 01)	2-1-28
Avoid Work Site Hazards	1-3-2	Continuity Check (d 02)	2-1-30
Use Special Care When Operating Loader	1-3-3	Battery Monitor (d 03)	2-1-32
Keep Riders Off Machine	1-3-3	Engine Sensors (d 04)	2-1-33
Avoid Backover Accidents	1-3-4	Transmission Sensors (d 05)	2-1-36
Avoid Machine Tip Over	1-3-4	Hydraulic Sensors (d 06)	2-1-38
Operating on Slopes	1-3-5	Fuel Sensor (d 07)	2-1-40
Operating Or Traveling On Public Roads	1-3-5	(d08)—Not Used	2-1-41
Inspect and Maintain ROPS	1-3-6	Machine I.D. Mode (d 10)	2-1-41
Add And Operate Attachments Safely	1-3-6	Horn Button	2-1-47
Safety—Maintenance Precautions			
Park And Prepare For Service Safely	1-4-1		
Service Cooling System Safely	1-4-1		
Remove Paint Before Welding or Heating	1-4-2		
Make Welding Repairs Safely	1-4-2		
Drive Metal Pins Safely	1-4-3		
Safety—Safety Signs			
Safety Signs	1-5-1		

Continued on next page

All information, illustrations and specifications in this manual are based on the latest information available at the time of publication. The right is reserved to make changes at any time without notice.

COPYRIGHT © 2003
DEERE & COMPANY
Moline, Illinois
All rights reserved
A John Deere ILLUSTRATION® Manual
Previous Editions
Copyright © 1997, 1998, 2000, 2001, 2002

Page	Page		
Turn Signals	2-1-47	Transmission, Hydraulic System, Park Brake, and Differential Oil	3-1-5
Air Conditioning Controls	2-1-48	Grease	3-1-6
Air Flow Knob	2-1-49	Diesel Engine Coolant	3-1-7
Adjusting Steering Wheel Tilt	2-1-49		
Opening and Securing Side Door	2-1-49	Maintenance—Periodic Maintenance	
Opening Side Window/Secondary Exit	2-1-51	Service Your Machine at Specified Intervals . . .	3-2-1
Opening Rear Side Window	2-1-51	Check the Monitor Display Unit Regularly	3-2-1
Adjusting Seat	2-1-52	Opening Engine Side Shields and Service Doors	3-2-2
Seat Belt	2-1-53	Locking Machine Frame	3-2-3
		Boom Lock	3-2-4
Operation—Operating the Machine		Opening Grille Door	3-2-5
Inspect Machine Daily Before Starting	2-2-1	Fuel Tank	3-2-5
Check Instruments Before Starting	2-2-2	Check Windshield Washer Fluid Level	3-2-5
Starting the Engine	2-2-2	Maintenance and Repair Record Keeping System	3-2-6
Starting Fluid—If Equipped (Cold Weather Starting Aid)	2-2-4	OILSCAN PLUS®, COOLSCAN PLUS®, and 3-Way Coolant Test Kit	3-2-7
Battery		Service Intervals	3-2-8
Using Booster Batteries—24 Volt System . . .	2-2-6		
Engine Air Heater—If Equipped	2-2-7	Maintenance—As Required	
Using Coolant Heater—If Equipped	2-2-7	Check Tire Pressure	3-3-1
Warm-Up	2-2-8	Tire Pressures	3-3-2
Cold Weather Warm-Up	2-2-8	Tighten Wheel Retainer Cap Screws	3-3-2
Neutral Lock	2-2-8	Check Fire Extinguisher—If Equipped	3-3-3
Shifting the Transmission	2-2-9	Clean or Replace Air Cleaner Elements	3-3-4
Park Brake Switch	2-2-10	Check Air Inlet Cover	3-3-4
Boom and Bucket Control Lever—One Lever Design	2-2-11	Inspect Serpentine Belt	3-3-5
Boom and Bucket Control Lever Two Lever Design	2-2-12	Drain Fuel Tank Sediment	3-3-6
Quick Shift Switch	2-2-13	Drain and Clean Primary Fuel Filter	3-3-7
Ride Control Switch—Earlier Machines (If Equipped)	2-2-14		
Ride Control—Later Machines (If Equipped) . .	2-2-16	Maintenance—Every 10 Hours or Daily	
Secondary Steering—If Equipped	2-2-17	Check Recovery Tank Coolant Level	3-4-1
Differential Lock Switch	2-2-18	Clean Air Cleaner Dust Unloader Valve	3-4-1
Boom Height Kickout Adjustment	2-2-18	Check Engine Oil Level	3-4-2
Return-to-Carry Kickout Adjustment	2-2-19	Check Hydraulic Oil Level	3-4-3
Return-To-Dig Adjustment (S.N. —574603) . .	2-2-20	Check Transmission Oil Level	3-4-4
Return-To-Dig Adjustment (S.N. 574603—) . .	2-2-22		
Fork Attachment	2-2-24	Maintenance—After First 100 Hours	
Parking the Machine	2-2-26	Change Engine Break-In Oil and Replace Filter	3-5-1
Loading Machine on a Trailer	2-2-27	Change Transmission Oil	3-5-3
Towing Procedure	2-2-29	Replace Transmission Oil Filter	3-5-5
Lifting the Machine	2-2-31		
		Maintenance—Every 100 Hours	
Maintenance—Machine		Grease Loader Linkage and Cylinder Pivots . . .	3-6-1
Diesel Fuel	3-1-1	Grease Front Steering Cylinder Pivots	3-6-3
Low Sulfur Diesel Fuel Conditioner	3-1-1	Grease Oscillating Rear Axle and Rear Steering Cylinder Pivots	3-6-3
Dieselscan Fuel Analysis	3-1-2		
Handling and Storing Diesel Fuel	3-1-2		
Alternative And Synthetic Lubricants	3-1-2		
Diesel Engine Break-In Oil	3-1-3		
Diesel Engine Oil	3-1-4		

Continued on next page

Page	Page		
Check Cab Fresh Air Filter—If Equipped With Cab.	3-6-3	Precautions for Alternator and Regulator	4-1-5
Check Cab Recirculating Air Filter—If Equipped With Cab.	3-6-6	Handling, Checking And Servicing Batteries Carefully	4-1-6
Maintenance—Every 250 Hours		Replacing Batteries	4-1-7
Grease Front Driveline Sliding Joint	3-7-1	Removing Batteries	4-1-8
Check Receiver Dryer Moisture Indicator	3-7-2	Replacing Fuses.	4-1-9
Check Radiator Coolant Level	3-7-2	Fuse (Blade-Type) Color Codes	4-1-11
Change Engine Oil and Replace Filter	3-7-3	Replacing Halogen Bulbs	4-1-12
Maintenance—Every 500 Hours		Engine Speeds	4-1-13
Lubricate Upper and Lower Drive Line Sliding Joints.	3-8-1	Checking Neutral Start System.	4-1-13
Check Air Intake Hoses	3-8-2	Servicing Air Conditioning System	4-1-14
Check Battery Electrolyte Level and Terminals	3-8-3	Welding on Machine.	4-1-14
Replace Primary Fuel Filter	3-8-5	External Service Brake Inspection	4-1-15
Replace Final Fuel Filter.	3-8-5	Checking Brake Accumulators	4-1-16
Replace Hydraulic System Return Filter	3-8-6	Checking Ride Control Accumulator—If Equipped	4-1-17
Grease Rear Oscillating Support Cover	3-8-6	Transmission Oil Cooler, Hydraulic Oil Cooler, Air-to-Air Aftercooler, and	4-1-19
Replace Hydraulic Reservoir Breather Filter.	3-8-7	Service Recommendations For STC® ¹ Fittings	4-1-20
Replace Transmission Oil Filter	3-8-8	Do Not Service Control Valves, Cylinders, Pumps or Motors	4-1-21
Check Park Brake Oil Level	3-8-10	Hardware Torque Specifications.	4-1-22
Check Front and Rear Differential Oil Level	3-8-11	Keep ROPS Installed Properly	4-1-22
Maintenance—Every 1000 Hours		Metric Bolt and Cap Screw Torque Values	4-1-23
Clean Engine Crankcase Vent Tube.	3-9-1	Unified Inch Bolt and Cap Screw Torque Values.	4-1-24
Replace Air Cleaner Dust Unloader Valve	3-9-1	Miscellaneous—Operational Checkout	
Replace Air Cleaner Elements	3-9-1	Operational Checkout.	4-2-1
Check Coolant	3-9-2	Checking and Clearing Diagnostic Trouble Codes From Monitor	4-2-1
Check Radiator Hoses	3-9-3	Engine Off Checks	4-2-3
Change Transmission Oil	3-9-4	Engine Running Checks.	4-2-5
Grease Frame Hinge Pivots	3-9-6	Miscellaneous—Troubleshooting	
Check Park Brake	3-9-7	Troubleshooting Procedure.	4-3-1
Change Park Brake Oil.	3-9-8	Diagnostic Trouble Codes Quick Reference List.	4-3-2
Maintenance—Every 2000 Hours		Engine	4-3-5
Adjust Engine Valve Lash (Clearance)	3-10-1	Diagnose	
Maintenance—Every 3000 Hours		Transmission System Malfunctions	4-3-7
Change Hydraulic System Oil.	3-11-1	Differential And Axle Malfunctions.	4-3-10
Clean Hydraulic System Strainer	3-11-2	Service Brake Malfunctions.	4-3-11
Change Front and Rear Differential Oil.	3-11-3	Drive Line Malfunctions.	4-3-12
Clean Axle Differential Recirculation Screen.	3-11-4	Park Brake Malfunctions	4-3-13
Miscellaneous—Machine		Loader Hydraulic System Malfunctions	4-3-14
Draining the Cooling System	4-1-1	Steering Malfunctions	4-3-16
Filling the Cooling System	4-1-2	Air Conditioning System	4-3-17
Replacing Engine Vibration Damper.	4-1-3	Heater System	4-3-19
Adjusting Pilot Controller Tower	4-1-4		
Checking Fuel Tank Vent Hose	4-1-4		
Bleeding Fuel System.	4-1-5		

Continued on next page

Page

Miscellaneous—Storage

Prepare Machine For Storage 4-4-1

Miscellaneous—Machine Numbers

Record Product Identification Number (PIN) . . . 4-5-1

Record Engine Serial Number 4-5-1

Record Transmission Serial Number 4-5-1

Record Hydraulic Pump Serial Number 4-5-1

Record Axle Serial Number 4-5-2

Miscellaneous—Specifications

624H/TC62H Specifications 4-6-1

624H High Lift Specifications 4-6-3

Drain and Refill Capacities—624H/TC62H 4-6-4

Miscellaneous—Crime Prevention Tips

Help Prevent Crime 4-7-1

Record Identification Numbers 4-7-1

Keep Proof of Ownership 4-7-1

Park Indoors Out of Sight 4-7-1

When Parking Outdoors 4-7-2

Reduce Vandalism 4-7-2

Report Thefts Immediately 4-7-3

Safety—Safety Features

Safety Features

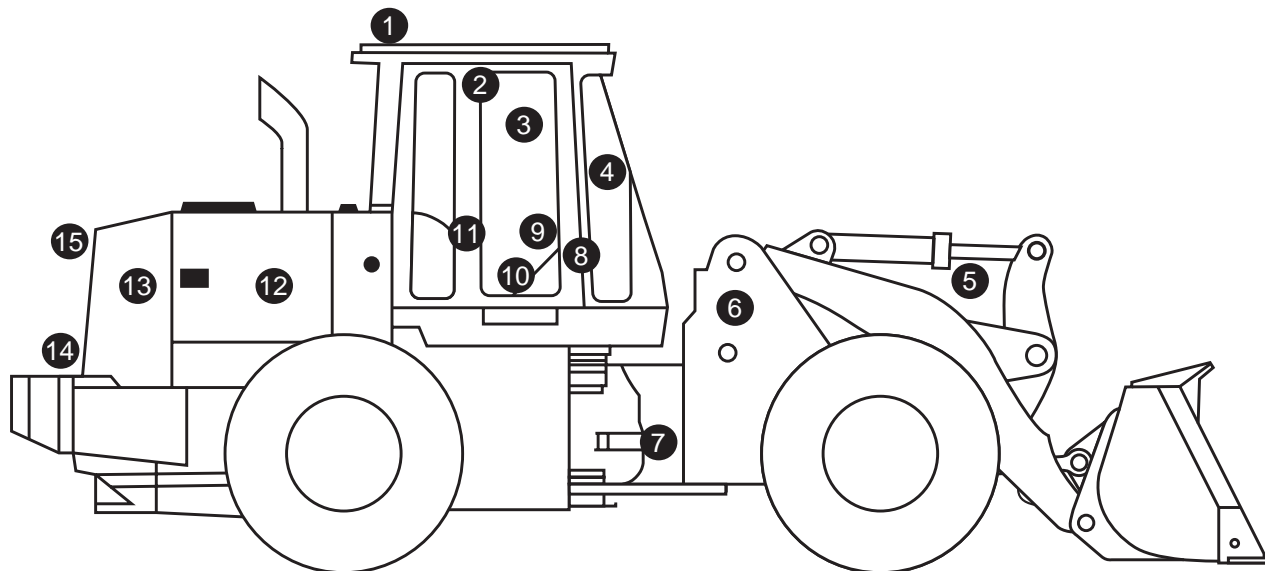

T138566

T138566 -UN-01JUN01

Please remember, the operator is the key to preventing accidents.

1. **ROPS, FOPS, and OPS.** Structures designed to help protect the operator are certified to ISO, SAE, and OSHA. Enclosures also deflect sun and rain.
2. **Pressurized Cab with Heater/Defroster.** Positive pressure ventilation system circulates both outside and inside air through filters for a clean working environment. Built in defroster vents direct air flow for effective window defogging/deicing.
3. **Mirrors.** Large exterior mirrors on both sides and an inside mirror offers operator a broad view of area behind machine.
4. **Large Windshield Wiper with Washer.** Extra long wiper cleans large windshield area.
5. **Loader Boom Service Lock.** Loader includes a mechanical lock for securing boom in the raised position before work is started on or around the machine.
6. **Halogen Lights and Turn Signals.** High intensity halogen drive/work lights and high-visibility turn signals are standard equipment.
7. **Articulation Locking Bar.** A self-storing mechanical lock is provided for transport or service.
8. **Handholds.** Large, conveniently placed handholds make it easy to enter or exit the operator's station or service area.
9. **Horn.** Standard horn is useful when driving or signaling co-workers.
10. **Independent Parking Brake.** Electronically controlled and engages whenever the engine is stopped.
11. **Seat Belt Retractors.** Seat belt retractors help keep belts clean and convenient to use.
12. **Bypass Start Protection.** Shielding over the starter terminals helps prevent dangerous bypass starting.
13. **Engine Fan Guard.** A secondary fan guard inside the engine compartment helps prevent contact with the rotating fan blades.
14. **Back Up Alarm.** Alerts bystanders when reverse travel direction is selected by operator.
15. **Stop and Signal Lights.** Highly visible stop lights are standard equipment.

TX03679,00016FD -19-14JUN01-1/1

Safety—General Precautions

Recognize Safety Information

This is the safety alert symbol. When you see this symbol on your machine or in this manual, be alert for the potential of personal injury.

Follow the precautions and safe operating practices highlighted by this symbol.

A signal word — DANGER, WARNING, or CAUTION — is used with the safety alert symbol. DANGER identifies the most serious hazards.

On your machine, DANGER signs are red in color, WARNING signs are orange, and CAUTION signs are yellow. DANGER and WARNING signs are located near specific hazards. General precautions are on CAUTION labels.



T133555 -JUN-28AUG00

T133588 -19-28AUG00

TX03679,00016CC -19-21AUG00-1/1

Follow Safety Instructions

Read the safety messages in this manual and on the machine. Follow these warnings and instructions carefully. Review them frequently.

Be sure all operators of this machine understand every safety message. Replace operator's manual and safety labels immediately if missing or damaged.



T133556 -JUN-24AUG00

TX03679,00016F9 -19-14MAR01-1/1

Operate Only If Qualified

Do not operate this machine unless you have read the operator's manual carefully and you have been qualified by supervised training and instruction.

Familiarize yourself with the job site and your surroundings before operating. Try all controls and

machine functions with the machine in an open area before starting to work.

Know and observe all safety rules that may apply to your work situation and your work site.

TX03679,00016FA -19-30OCT00-1/1

Wear Protective Equipment

Guard against injury from flying pieces of metal or debris; wear goggles or safety glasses.

Wear close fitting clothing and safety equipment appropriate to the job.

Prolonged exposure to loud noise can cause impairment or loss of hearing. Wear suitable hearing protection such as earmuffs or earplugs to protect against objectionable or uncomfortable loud noises.

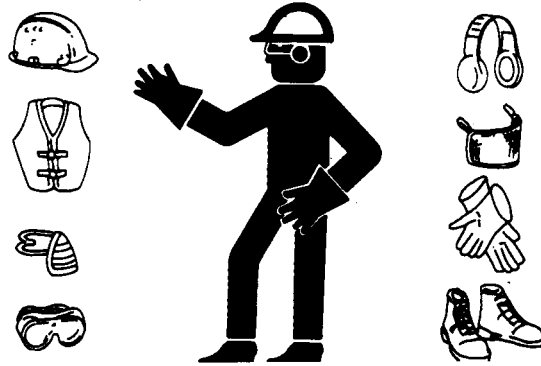

TS206 -JUN-23AUG88

TX03679,00016D0 -19-30OCT00-1/1

Avoid Unauthorized Machine Modifications

Modifications of this machine, or addition of unapproved products or attachments, may affect machine stability or reliability, and may create a hazard for the operator or others near the machine.

Always contact an authorized dealer before making machine modifications that change the intended use, weight or balance of the machine, or that alter machine controls, performance or reliability.

TX03679,00016B7 -19-30OCT00-1/1

Add Cab Guarding For Special Uses

Special work situations or machine attachments may create an environment with falling or flying objects. Loading logs, using fork attachments, or operating in waste management applications requires special work tools. Added cab guarding to protect the operator may also be required.

Use load-clamping grapples to keep bulky loads from falling and add special screens or guarding when objects may be directed toward the cab. Contact your authorized dealer for information on devices intended to protect the operator from falling or flying objects in special work situations.

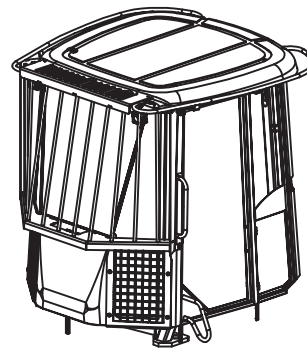

T141893 -JUN-04MAY01

TX03679,00017C6 -19-01JUN01-1/1

Inspect Machine

Inspect machine carefully each day by walking around it before starting.

Keep all guards and shields in good condition and properly installed. Fix damage and replace worn or broken parts immediately. Pay special attention to hydraulic hoses and electrical wiring.



T6607AQ -JUN-18OCT88

TX03679,0001734 -19-25SEP00-1/1

Stay Clear Of Moving Parts

Entanglements in moving parts can cause serious injury.

Stop engine before examining, adjusting or maintaining any part of machine with moving parts.

Keep guards and shields in place. Replace any guard or shield that has been removed for access as soon as service or repair is complete.

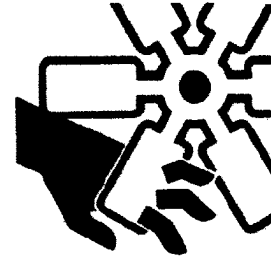

T133592 -JUN-12SEP01

TX03679,00016D2 -19-30OCT00-1/1

Avoid High-Pressure Fluids

This machine uses a high-pressure hydraulic system. Escaping fluid under pressure can penetrate the skin causing serious injury.

Never search for leaks with your hands. Protect hands. Use a piece of cardboard to find location of escaping fluid. Stop engine and relieve pressure before disconnecting lines or working on hydraulic system.

If hydraulic fluid penetrates your skin, see a doctor immediately. Injected fluid must be removed surgically within hours or gangrene may result. Contact a knowledgeable medical source or the Deere & Company Medical Department in Moline, Illinois, U.S.A.

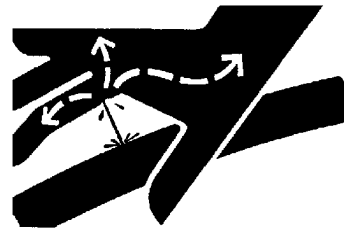

T133509 -JUN-31OCT00

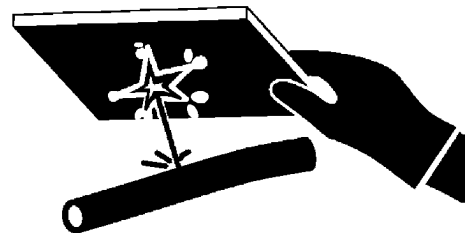

T133840 -JUN-20SEP00

TX03679,00016D3 -19-30OCT00-1/1

Beware Of Exhaust Fumes

Prevent asphyxiation. Engine exhaust fumes can cause sickness or death.

If you must operate in a building, provide adequate ventilation. Use an exhaust pipe extension to remove the exhaust fumes or open doors and windows to bring outside air into the area.



T133546 -JUN-24AUG00

TX03679,00016D4 -19-14SEP00-1/1

Prevent Fires

Handle Fuel Safely: Store flammable fluids away from fire hazards. Never refuel machine while smoking or when near sparks or flame.

Clean Machine Regularly: Keep trash, debris, grease and oil from accumulating in engine compartment, around fuel lines, hydraulic lines and electrical wiring. Never store oily rags or flammable materials inside a machine compartment.

Maintain Hoses and Wiring: Replace hydraulic hoses immediately if they begin to leak, and clean up any oil spills. Examine electrical wiring and connectors frequently for damage.

Keep A Fire Extinguisher Available: Always keep a multi-purpose fire extinguisher on or near the machine. Know how to use extinguisher properly.

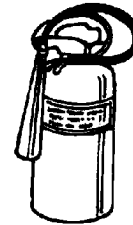
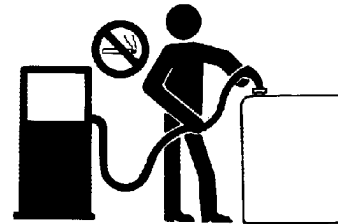

T133552 -JUN-14SEP00

T133553 -JUN-07SEP00

T133554 -JUN-07SEP00

TX03679,00016F5 -19-25SEP00-1/1

Prevent Battery Explosions

Battery gas can explode. Keep sparks, lighted matches, and open flame away from the top of battery.

Never check battery charge by placing a metal object across the posts. Use a voltmeter or hydrometer.

Do not charge a frozen battery; it may explode. Warm battery to 16°C (60°F).



TS204 -JUN-23AUG88

TX03679,000174A -19-14SEP00-1/1

Handle Chemical Products Safely

Exposure to hazardous chemicals can cause serious injury. Under certain conditions, lubricants, coolants, paints and adhesives used with this machine may be hazardous.

If uncertain about safe handling or use of these chemical products, contact your authorized dealer for a Material Safety Data Sheet (MSDS) or go to internet website <http://www.jdmsds.com>. The MSDS describes physical and health hazards, safe use procedures, and emergency response techniques for chemical substances. Follow MSDS recommendations to handle chemical products safely.

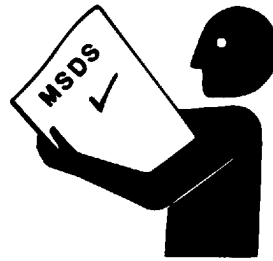

T133580 -JUN-25AUG00

TX03679,00016D7 -19-05AUG02-1/1

Dispose of Waste Properly

Improper disposal of waste can threaten the environment. Fuel, oils, coolants, filters and batteries used with this machine may be harmful if not disposed of properly.

Never pour waste onto the ground, down a drain, or into any water source.

Air conditioning refrigerants can damage the atmosphere. Government regulations may require using a certified service center to recover and recycle used refrigerants.

If uncertain about the safe disposal of waste, contact your local environmental or recycling center or your dealer for more information.

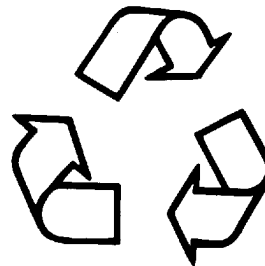

T133567 -JUN-25AUG00

TX03679,0001733 -19-14SEP00-1/1

Prepare for Emergencies

Be prepared if an emergency occurs or a fire starts.

Keep a first aid kit and fire extinguisher handy.

Keep emergency numbers for doctors, ambulance service, hospital, and fire department near your telephone.

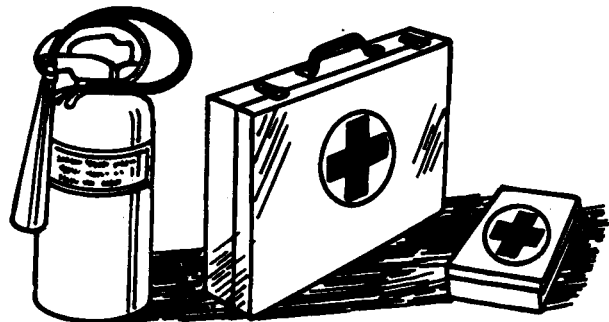

TS291 -JUN-23AUG88

TX03679,000174B -19-14SEP00-1/1

Safety—Operating Precautions

Use Steps And Handholds Correctly

Prevent falls by facing the machine when you get on and off. Maintain 3-point contact with steps and handrails. Never use machine controls as handholds.

Use extra care when mud, snow, or moisture present slippery conditions. Keep steps clean and free of grease or oil. Never jump when exiting machine. Never mount or dismount a moving machine.

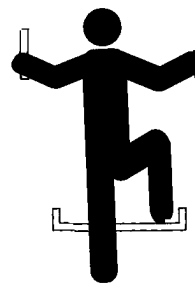

T133468 -JUN-30AUG00

TX03679,00016F2 -19-14SEP00-1/1

Start Only From Operator's Seat

Avoid unexpected machine movement. Start engine only while sitting in operator's seat. Ensure all controls and working tools are in proper position for a parked machine.

Never attempt to start engine from the ground. Do not attempt to start engine by shorting across the starter solenoid terminals.



T133715 -JUN-07SEP00

TX03679,0001799 -19-02MAY01-1/1

Use And Maintain Seat Belt

Use seat belt when operating machine. Remember to fasten seat belt when loading and unloading from trucks and during other uses.

Examine seat belt frequently. Be sure webbing is not cut or torn. Replace seat belt immediately if any part is damaged or does not function properly.

The complete seat belt assembly should be replaced every three years, regardless of appearance.



**USE
SEAT
BELT**

T133716 -19-14SEP00

TX03679,00016DD -19-17OCT00-1/1

Prevent Unintended Machine Movement

When co-workers are present, disable hydraulics.

Lower all equipment to the ground during work interruptions. Lock transmission control in neutral, engage park brake and stop engine before allowing anyone to approach the machine.

Follow these same precautions before standing up, leaving the operator's seat, or exiting the machine.

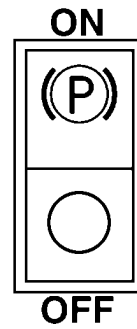

TX03679,00017C7 -19-28OCT02-1/1

T142001 -UN-15MAY01

Avoid Work Site Hazards

Avoid contact with gas lines, buried cables and water lines. Call utility line location services to identify all underground utilities before starting work.

Prepare work site properly. Avoid operating near structures or objects that could fall onto the machine. Clear away debris that could move unexpectedly if run over.

Avoid boom or attachment contact with overhead obstacles or overhead electrical lines. Never move any part of machine or load closer than 3 m (10 ft) plus twice the line insulator length to overhead wires.

Keep bystanders clear at all times. Use barricades or a signal person to keep vehicles and pedestrians away. Use a signal person if moving machine in congested areas or where visibility is restricted. Always keep signal person in view. Coordinate hand signals before starting machine.

Operate only on solid footing with strength sufficient to support machine. Be especially alert working near embankments or excavations.

Avoid working under over-hanging embankments or stockpiles that could collapse on machine.

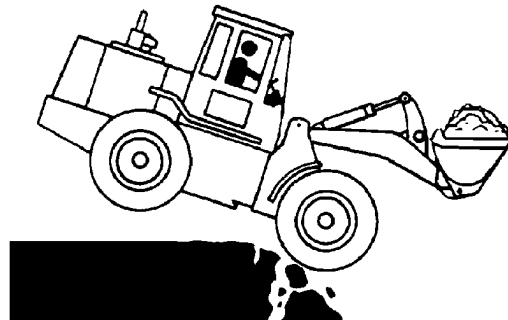
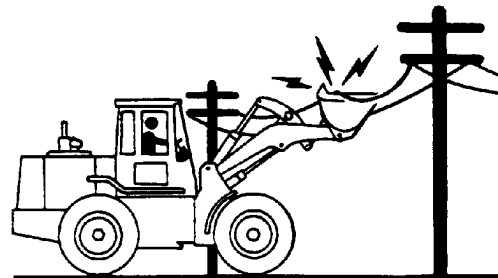
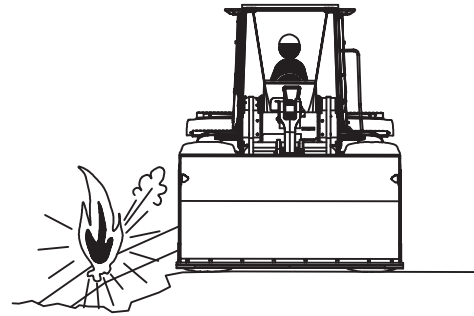

TX03679,000179A -19-02MAY01-1/1

T141894 -UN-15JUN01

T141670 -UN-24APR01

T141672 -UN-04MAY01

Use Special Care When Operating Loader

Never use the loader to lift people. Do not allow anyone to ride in the bucket or use the bucket as a work platform.

Operate carefully with raised loads. Raising the load reduces machine stability, especially on side slopes or an unstable surface. Drive and turn slowly with a raised load.

Ensure that objects in the bucket are secure. Do not attempt to lift or carry objects that are too big or too long to fit inside the bucket unless secured with an adequate chain or other device. Keep bystanders away from raised loads.

Be careful when lifting objects. Never attempt to lift objects too heavy for your machine. Assure machine stability and hydraulic capability with a test lift before attempting other maneuvers. Use an adequate chain or sling and proper rigging techniques to attach and stabilize loads. Never lift an object above or near another person.

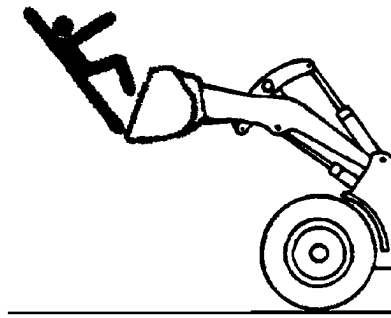

T141957 -JUN-15MAY01

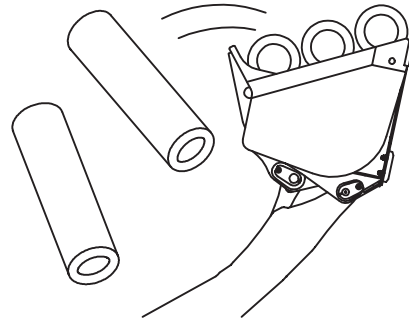

T141902 -JUN-07MAY01

TX03768,0000B70 -19-14MAY01-1/1

Keep Riders Off Machine

Only allow operator on machine.

Riders are subject to injury. They may fall from machine, be caught between machine parts, or be struck by foreign objects.

Riders may obstruct operator's view or impair his ability to operate machine safely.

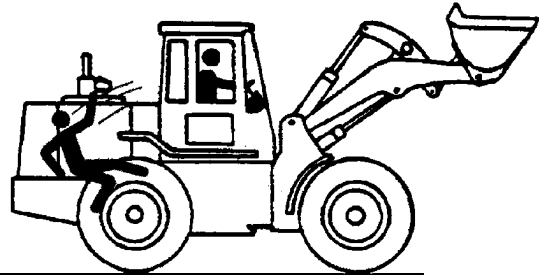

T141671 -JUN-04MAY01

TX03679,000179B -19-20APR01-1/1

Avoid Backover Accidents

Before moving machine, be sure all persons are clear of machine path. Turn around and look directly for best visibility. Use mirrors to assist in checking all around machine. Keep windows and mirrors clean, adjusted, and in good repair.

Be certain reverse warning alarm is working properly.

Use a signal person when backing if view is obstructed or when in close quarters. Keep signal person in view at all times. Use prearranged hand signals to communicate.

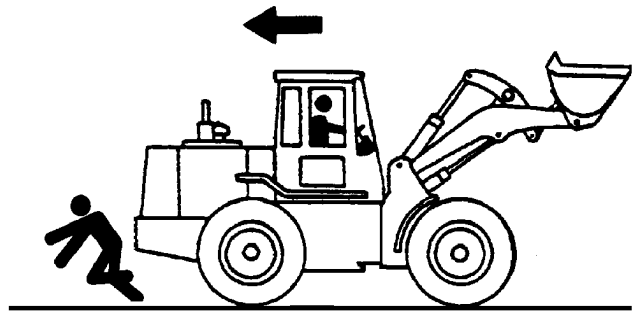

T141673 -JUN-04MAY01

TX03679,000179C -19-20APR01-1/1

Avoid Machine Tip Over

Use seat belt at all times.

Do not jump if the machine tips. You will be unlikely to jump clear and the machine may crush you.

Load and unload from trucks or trailers carefully. Be sure truck is wide enough and on a firm level surface. Use loading ramps and attach them properly to truck bed.

Be careful on slopes. Avoid sharp turns. Balance loads so weight is evenly distributed and load is stable. Carry tools and loads close to the ground to aid visibility and lower center of gravity. Use extra care on soft, rocky or frozen ground.

Know the capacity of the machine. Do not overload. Be careful with heavy loads. Using oversize buckets or lifting heavy objects reduces machine stability.

Ensure solid footing. Use extra care in soft ground conditions that may not uniformly support the wheels, especially when raising the boom. Do not operate close to banks or open excavations that may cave in and cause machine to tip or fall.



USE SEAT BELT

T133716 -19-14SEP00

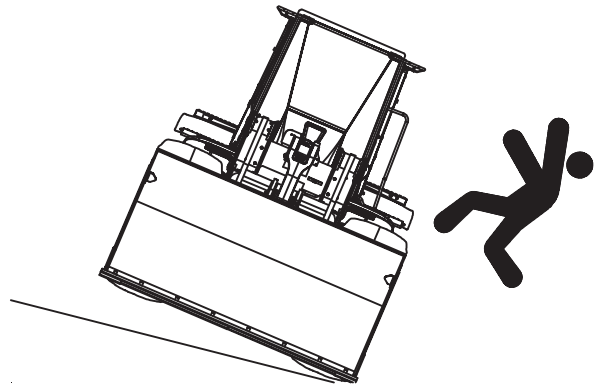

T141676 -JUN-04MAY01

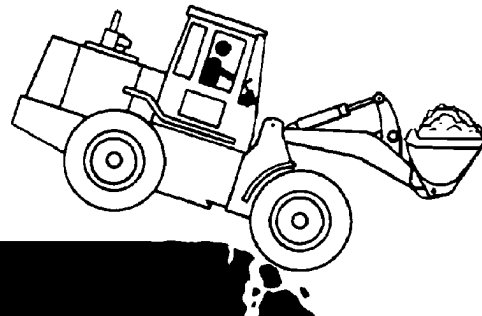

T141672 -JUN-04MAY01

TX03679,000179D -19-02MAY01-1/1

Operating on Slopes

Avoid side slope travel whenever possible. Drive up steep slope in forward and down in reverse.

Select low gear speed before starting down slope. The grade of the slope will be limited by ground condition and load being handled.

Use service brakes to control speed. Sudden brake application with a loaded bucket on downhill side could cause machine to tip forward.

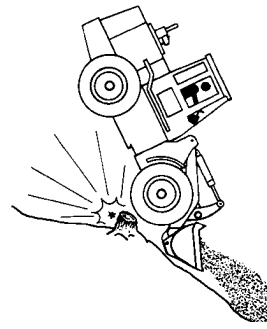

T141681 -JUN-30APR01

TX03679,000179E -19-14MAY01-1/1

Operating Or Traveling On Public Roads

Machines that work near vehicle traffic or travel slower than normal highway speeds must have proper lighting and markings to assure they are visible to other drivers.

Install additional lights, beacons, slow moving vehicle (SMV) emblems, or other devices and use as required to make the machine visible and identify it as a work machine. Check state and local regulations to assure compliance. Keep these devices clean and in working condition.

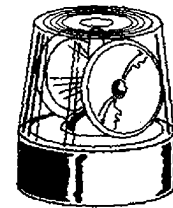
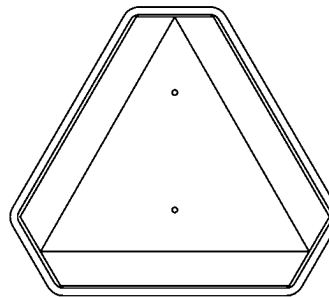

T141891 -JUN-22MAY01

TX03679,00017C8 -19-14JUN01-1/1

Inspect and Maintain ROPS

A damaged roll-over protective structure (ROPS) should be replaced, not reused.

The protection offered by ROPS will be impaired if ROPS is subjected to structural damage, is involved in an overturn incident, or is in any way altered by welding, bending, drilling, or cutting.

If ROPS was loosened or removed for any reason, inspect it carefully before operating the machine again.

To maintain the ROPS:

- Replace missing hardware using correct grade hardware.
- Check hardware torque.
- Check isolation mounts for damage, looseness or wear; replace them if necessary.
- Check ROPS for cracks or physical damage.

TX03679,000179F –19–20APR01–1/1

Add And Operate Attachments Safely

Always verify compatibility of attachments by contacting your authorized dealer. Adding unapproved attachments may affect machine stability or reliability, and may create a hazard for others near the machine.

Ensure that a qualified person is involved in attachment installation. Add guards to machine if operator protection is required or recommended. Verify

that all connections are secure and attachment responds properly to controls.

Carefully read attachment manual and follow all instructions and warnings. In an area free of bystanders and obstructions, carefully operate attachment to learn its characteristics and range of motion.

TX03679,00016F0 –19–14SEP00–1/1