

# **310G, 310SG & 315SG Backhoe Loader (S.N. 910056—)**

## **OPERATOR'S MANUAL 310G, 310SG and 315SG Backhoe Loaders**

**OMT191038 Issue A4 (ENGLISH)**

**CALIFORNIA  
Proposition 65 Warning**

Diesel engine exhaust and some of its constituents are known to the State of California to cause cancer, birth defects, and other reproductive harm.

If this product contains a gasoline engine:

** WARNING**

The engine exhaust from this product contains chemicals known to the State of California to cause cancer, birth defects or other reproductive harm.

The State of California requires the above two warnings.

**Worldwide Construction  
And Forestry Division**  
LITHO IN U.S.A.

# Introduction

## Foreword

READ THIS MANUAL carefully to learn how to operate and service your machine correctly. Failure to do so could result in personal injury or equipment damage. This manual and safety signs on your machine may also be available in other languages. (See your John Deere dealer to order.)

THIS MANUAL SHOULD BE CONSIDERED a permanent part of your machine and should remain with the machine when you sell it.

MEASUREMENTS in this manual are given in both metric and customary U.S. unit equivalents. Use only correct replacement parts and fasteners. Metric and inch fasteners may require a specific metric or inch wrench.

RIGHT-HAND AND LEFT-HAND sides are determined by facing in the direction of forward travel.

WRITE PRODUCT IDENTIFICATION NUMBERS (P.I.N.) in the Machine Numbers section. Accurately record all the numbers to help in tracing the machine should it be stolen. Your dealer also needs these

numbers when you order parts. File the identification numbers in a secure place off the machine.

WARRANTY is provided as part of John Deere's support program for customers who operate and maintain their equipment as described in this manual. The warranty is explained on the warranty certificate which you should have received from your dealer.

This warranty provides you the assurance that John Deere will back its products where defects appear within the warranty period. In some circumstances, John Deere also provides field improvements, often without charge to the customer, even if the product is out of warranty. Should the equipment be abused, or modified to change its performance beyond the original factory specifications, the warranty will become void and field improvements may be denied. Setting fuel delivery above specifications or otherwise overpowering machines will result in such action.

THE TIRE MANUFACTURER'S warranty supplied with your machine may not apply outside the U.S.

DX,IFC7 -19-16NOV01-1/1

## Emission Control Statement

### EMISSIONS CONTROL WARRANTY STATEMENT FOR NEW JOHN DEERE CONSTRUCTION EQUIPMENT (U.S. AND CANADA)

To determine if the engine in your machine qualifies for the additional warranties set forth below, look for the "Engine Information" label located on your engine. If you reside in the United States and the engine label states: "Engine conforms to US EPA regulations on heavy duty non road diesel cycle engines," you are entitled to the "U.S. Emission Control Warranty Statement." If you reside in California, and the engine label states: "Engine conforms to California regulations on heavy duty non road diesel cycle engines," you are entitled to the "California Emission Control Warranty Statement."

#### U.S. EPA EMISSIONS CONTROL WARRANTY STATEMENT

Emissions control-related parts and components are warranted by John Deere for five years or 3000 hours of operation, whichever occurs first. John Deere further warrants that the engine covered by this warranty was designed, built, and equipped so as to conform at the time of sale with all U.S. emissions standards at the time of manufacture, and that it is free of defects in materials and workmanship which would cause it not to meet these standards within the period of five years or 3000 hours of operations, whichever occurs first.

Warranties stated on this certificate refer only to emissions-related parts and components of your engine. The complete machine warranty, less emissions-related parts and components, is provided separately as "John Deere "Secure Warranty" For New Construction Products."

#### CALIFORNIA EMISSION CONTROL WARRANTY STATEMENT YOUR WARRANTY RIGHTS AND OBLIGATIONS

The California Air Resources Board (CARB) and John Deere are pleased to explain the emission control system on your new engine. In California, new heavy-duty engines must be designed, built and equipped to meet the State's stringent anti-smog standards. John Deere must warrant the emission control system on your engine for the periods of time listed below provided there has been no abuse, neglect, or improper maintenance of your machine.

Your emissions control system includes:

Fuel Metering System  
Fuel Injection System

Air Induction System  
Intake Manifold  
Turbocharger System  
Charge Air Cooling System

Miscellaneous Items used in Above Systems

Where a warrantable condition exists, i.e. failure due to defect in John Deere-supplied material and/or workmanship, John Deere will repair your heavy-duty engine at no cost to you including diagnosis, parts and labor

#### JOHN DEERE'S WARRANTY COVERAGE:

The emission control system of your heavy-duty engine is warranted for five years or 3000 hours of operation, whichever occurs first. If any emission-related part on your engine is defective, the part will be repaired or replaced by John Deere. Warranties stated on this certificate refer only to emissions-related parts and components of your engine. The complete machine warranty, less emissions-related parts and components, is provided separately as the "John Deere "Secure Warranty" For New Construction Products."

#### OWNER'S WARRANTY RESPONSIBILITIES:

As the heavy-duty engine owner, you are responsible for the performance of the required maintenance as outlined in the

Operator's Manual. John Deere recommends that you retain all receipts covering maintenance on your heavy-duty engine, but John Deere cannot deny warranty solely for the lack of receipts or for your failure to ensure the performance of all scheduled maintenance.

However, as the heavy-duty engine owner, you should be aware that John Deere may deny you warranty coverage if your heavy-duty engine or a part has failed due to abuse, neglect, improper maintenance or unapproved modifications.

Your engine is designed to operate on diesel fuel only. Use of any other fuel may result in your engine no longer operating in compliance with California's emissions requirements.

You are responsible for initiating the warranty process. The CARB suggests that you present your machine to the nearest authorized John Deere dealer as soon as a problem is suspected. The warranty repairs should be completed by the service dealer as expeditiously as possible.

If you have any questions regarding your warranty rights and responsibilities, you should contact John Deere at 1-319-292-5400, or the State of California Air Resources Board, Mobile Source Operation Division, PO Box 8001, El Monte, CA 91731-2900

The warranty period begins on the date the machine is delivered to an ultimate purchaser, or when otherwise put into service. John Deere warrants to the ultimate purchaser and each subsequent purchaser that the engine is designed, built and equipped so as to conform with all applicable regulations adopted by the Air Resources Board, and that it is free from defects in materials and workmanship which would cause the failure of a warranted part.

Any warranted part which is scheduled for replacement as required maintenance by the operator's manual is warranted by John Deere for the period of time prior to the first scheduled replacement point for that part. If the part fails prior to the first scheduled replacement point, the part shall be repaired or replaced under warranty. Any such part repaired or replaced under warranty is warranted for the remainder of the period prior to the first scheduled replacement point for that part.

Any warranted part which is not scheduled for replacement as required maintenance, or which is scheduled only for regular inspection to the effect of repairing or replacing as necessary, is warranted for the warranty period.

Repair or replacement of a warranted part will be performed at no charge to you by an authorized John Deere dealer. You will not be charged for diagnostic labor which leads to the determination that a warranted part is defective, if the diagnostic work is performed by a John Deere dealer.

John Deere is liable for damages to other engine components caused by failure under warranty of any warranted part.

John Deere is NOT liable for travel or mileage on extended emissions warranty service calls.

Any replacement part may be used in the performance of any maintenance or repairs, and such use will not reduce the warranty obligations of John Deere. However, the use of add-on or modified parts are grounds for disallowing a warranty claim.

### Technical Information Feedback Form

We need your help to continually improve our technical publications. Please copy this page and FAX or mail your comments, ideas and improvements.

**SEND TO:** John Deere Dubuque Works  
P.O. Box 538  
Attn: Publications Supervisor, Dept. 303  
Dubuque, IA 52004-0538

**FAX NUMBER:** 563-589-5800

Ideas, Comments (Please State Page Number): \_\_\_\_\_  
\_\_\_\_\_  
\_\_\_\_\_  
\_\_\_\_\_  
\_\_\_\_\_  
\_\_\_\_\_  
\_\_\_\_\_  
\_\_\_\_\_  
\_\_\_\_\_  
\_\_\_\_\_  
\_\_\_\_\_  
\_\_\_\_\_  
\_\_\_\_\_  
\_\_\_\_\_  
\_\_\_\_\_

OVERALL, how would you rate the quality of this publication? (Check one)

	Poor		Fair		Good		Very Good		Excellent
1	2	3	4	5	6	7	8	9	10

Company Name: \_\_\_\_\_  
Technician Name: \_\_\_\_\_  
Address: \_\_\_\_\_  
Phone: \_\_\_\_\_  
Fax No.: \_\_\_\_\_  
Dealer Acct. No.: \_\_\_\_\_

**THANK YOU!**

# Contents

	Page		Page
<b>Safety—Safety Features</b>		<b>Safety—Safety Signs</b>	
Safety Features . . . . .	1-1-1	Safety Signs (S.N. 910056—919463) . . . . .	1-5-1
		Safety Signs (S.N. 919464—) . . . . .	1-5-3
<b>Safety—General Precautions</b>		<b>Operation—Operator's Station</b>	
Recognize Safety Information . . . . .	1-2-1	Pedals and Levers . . . . .	2-1-1
Follow Safety Instructions . . . . .	1-2-1	Pedals and Levers—If Equipped With Pilot Controls . . . . .	2-1-1
Operate Only If Qualified . . . . .	1-2-2	Display Monitor Functions . . . . .	2-1-2
Wear Protective Equipment . . . . .	1-2-2	Right-Side Console Functions . . . . .	2-1-5
Avoid Unauthorized Machine Modifications . . . . .	1-2-2	Controls—Steering Console . . . . .	2-1-8
Inspect Machine . . . . .	1-2-3	Pilot Control Enable/Disable Switch—If Equipped . . . . .	2-1-9
Stay Clear Of Moving Parts . . . . .	1-2-3	Pattern Select Switch—If Equipped (S.N. 910056—919463) . . . . .	2-1-9
Avoid High-Pressure Fluids . . . . .	1-2-3	Horn Button . . . . .	2-1-10
Beware Of Exhaust Fumes . . . . .	1-2-4	Defroster, Heater, and Air Conditioner Controls—If Equipped . . . . .	2-1-11
Prevent Fires . . . . .	1-2-4	Side Windows—Secondary Exits . . . . .	2-1-12
Prevent Battery Explosions . . . . .	1-2-4	Rear Windows . . . . .	2-1-12
Handle Chemical Products Safely . . . . .	1-2-5	Adjusting Seat . . . . .	2-1-13
Dispose Of Waste Properly . . . . .	1-2-5	Seat Belt . . . . .	2-1-15
Prepare For Emergencies . . . . .	1-2-5	Steering Wheel Tilt Lever—If Equipped . . . . .	2-1-15
<b>Safety—Operating Precautions</b>		<b>Operation—Operating The Machine</b>	
Use Steps And Handholds Correctly . . . . .	1-3-1	Inspect Machine Daily Before Starting . . . . .	2-2-1
Start Only From Operator's Seat . . . . .	1-3-1	Check Instruments Before Starting . . . . .	2-2-2
Use And Maintain Seat Belt . . . . .	1-3-1	Starting the Engine . . . . .	2-2-3
Prevent Unintended Machine Movement . . . . .	1-3-2	Starting Fluid—Cold Weather Start Aid—If Equipped . . . . .	2-2-5
Prevent Unintended Machine Movement—If Equipped With Pilot Controls . . . . .	1-3-2	Using Booster Batteries—12-Volt System . . . . .	2-2-7
Avoid Work Site Hazards . . . . .	1-3-3	Using Coolant Heater—If Equipped . . . . .	2-2-8
Keep Riders Off Machine . . . . .	1-3-3	Warm-Up . . . . .	2-2-8
Avoid Backover Accidents . . . . .	1-3-4	Cold Weather Warm-Up . . . . .	2-2-9
Avoid Machine Tipover . . . . .	1-3-4	Ride Control Operation—If Equipped . . . . .	2-2-10
Add And Operate Attachments Safely . . . . .	1-3-5	Pilot Control Operation—If Equipped . . . . .	2-2-11
Use Special Care When Operating . . . . .	1-3-5	Driving the Machine . . . . .	2-2-12
Operating Or Traveling On Public Roads . . . . .	1-3-6	Operating Stabilizers . . . . .	2-2-15
Inspect and Maintain ROPS . . . . .	1-3-6	Operating Boom Lock—310G, 310SG . . . . .	2-2-16
		Operating Boom Lock—315SG . . . . .	2-2-17
		Operating Swing Lock . . . . .	2-2-18
<b>Safety—Maintenance Precautions</b>		<b>Continued on next page</b>	
Park And Prepare For Service Safely . . . . .	1-4-1		
Service Cooling System Safely . . . . .	1-4-1		
Remove Paint Before Welding or Heating . . . . .	1-4-2		
Make Welding Repairs Safely . . . . .	1-4-2		
Drive Metal Pins Safely . . . . .	1-4-3		

*All information, illustrations and specifications in this manual are based on the latest information available at the time of publication. The right is reserved to make changes at any time without notice.*

COPYRIGHT © 2003  
DEERE & COMPANY  
Moline, Illinois  
All rights reserved  
A John Deere ILLUSTRATION® Manual  
Previous Editions  
Copyright © 2000, 2002

	Page		Page
Operating Backhoe—John Deere		Service Intervals . . . . .	3-2-6
Two-Lever Controls . . . . .	2-2-19	Required Parts . . . . .	3-2-8
Operating Backhoe—Excavator Two-Lever			
Controls . . . . .	2-2-20	<b>Maintenance—As Required</b>	
Operating Backhoe—John Deere Pilot		Inspect Loader Boom Service Lock . . . . .	3-3-1
Controls . . . . .	2-2-21	Check and Adjust Boom Lock-310G, 310SG . .	3-3-1
Operating Backhoe—Excavator Pilot		Check Tire Pressure . . . . .	3-3-2
Controls . . . . .	2-2-22	Tire Inflation Pressures . . . . .	3-3-3
Side-Shifting the Backhoe Boom—315SG . . .	2-2-23	Check Wheel Fasteners . . . . .	3-3-4
Operating Extendible Dipperstick—If		Clean Cab Air Filters . . . . .	3-3-5
Equipped . . . . .	2-2-24	Inspect and Clean Hydraulic Reservoir	
Operating Extendible Dipperstick Lock—If		Fill Screen . . . . .	3-3-6
Equipped . . . . .	2-2-25	Drain Fuel Tank Water and Sediment . . . . .	3-3-6
Operating Backhoe Auxiliary Hydraulic		Clean Engine Air Cleaner Dust Unloader	
Functions—If Equipped . . . . .	2-2-26	Valve . . . . .	3-3-7
Operating Loader . . . . .	2-2-27	Clean or Replace Air Cleaner Elements . . . . .	3-3-8
Operating Differential Lock . . . . .	2-2-28	Inspect Belt . . . . .	3-3-9
Operating Mechanical Front Wheel Drive		Grease MFWD Drive Shaft Splines—If	
(MFWD)—If Equipped . . . . .	2-2-29	Equipped . . . . .	3-3-9
Lifting . . . . .	2-2-30	Grease Sideshift Rails—315SG . . . . .	3-3-9
Parking the Machine . . . . .	2-2-31	Grease Stabilizer Leg Wear Strips—315SG . .	3-3-10
Loading Machine on a Trailer . . . . .	2-2-33	Grease Extendible Dipperstick Side Rails—	
Towing . . . . .	2-2-34	If Equipped . . . . .	3-3-10
		Grease Extendable Dipperstick Backhoes—	
<b>Maintenance—Machine</b>		If Equipped . . . . .	3-3-11
Diesel Fuel . . . . .	3-1-1	Grease Front Wheel	
Low Sulfur Diesel Fuel Conditioner . . . . .	3-1-1	Bearings—Non-Powered (S.N.—911129) . .	3-3-11
Dieselscan Fuel Analysis . . . . .	3-1-2	Grease Front Wheel	
Handling and Storing Diesel Fuel . . . . .	3-1-2	Bearings—Non-Powered (S.N. 911130—) . .	3-3-12
Alternative and Synthetic Lubricants . . . . .	3-1-3		
Diesel Engine Break-In Oil . . . . .	3-1-3	<b>Maintenance—Every 10 Hours or Daily</b>	
Diesel Engine Oil . . . . .	3-1-4	Checking Hydraulic Reservoir Oil Level . . . . .	3-4-1
Transmission, Hydraulic, Axles, and		Check Engine Oil Level . . . . .	3-4-2
Mechanical Front Wheel Drive Oil . . . . .	3-1-5	Check Coolant Level . . . . .	3-4-3
Grease . . . . .	3-1-6	Grease Loader Pivots . . . . .	3-4-4
Grease For Extendible Dipperstick,		Grease 4-in-1 Bucket Pivots—If Equipped . . . .	3-4-5
Sideshift Frame, And Stabilizer Leg Wear		Grease Stabilizer Pivots and Cylinder Pins . . . .	3-4-5
Strips . . . . .	3-1-6	Grease Backhoe Linkage, Pivots, and	
Diesel Engine Coolant . . . . .	3-1-7	Cylinder Rod Ends . . . . .	3-4-6
		Grease Non-Powered Front Axle and	
<b>Maintenance—Periodic Maintenance</b>		Steering Pivots (S.N.—911129) . . . . .	3-4-8
Service Your Machine at Specified Intervals . . .	3-2-1	Grease Non-Powered Front Axle and	
Check Hour Meter Regularly . . . . .	3-2-1	Steering Pivots (S.N. 911130—) . . . . .	3-4-9
Prepare Machine for Maintenance . . . . .	3-2-2	Grease MFWD Front Axle and Universal	
Loader Boom Service Lock . . . . .	3-2-2	Joints—If Equipped . . . . .	3-4-10
Opening and Closing Engine Hood . . . . .	3-2-3		
Fuel Tank . . . . .	3-2-3	<b>Maintenance—After First 100 Hours</b>	
Maintenance And Repair Record		Change Engine Break-In Oil And	
Keeping System . . . . .	3-2-4	Replace Filter . . . . .	3-5-1
OILSCAN PLUS®, COOLSCAN PLUS®,		Replace Transmission Oil Filter . . . . .	3-5-2
DIESELSCAN, and 3-Way Coolant Test			
Kit . . . . .	3-2-5		

Continued on next page



Page	Page
<b>Maintenance—Every 250 Hours</b>	
Check MFWD Planetary Housing Oil—If Equipped . . . . .	3-6-1
Check MFWD Axle Oil Level—If Equipped . . . . .	3-6-1
Check Battery Electrolyte Level and Terminals . . . . .	3-6-2
Check Rear Axle Oil Level . . . . .	3-6-4
Check Transmission Oil Level . . . . .	3-6-4
<b>Maintenance—Every 500 Hours</b>	
Check Coolant and Add Conditioner. . . . .	3-7-1
Check Air Intake Hose . . . . .	3-7-2
Replace Hydraulic Oil Filter . . . . .	3-7-2
Check Boom-to-Dipperstick Pin Bolt Torque. . . . .	3-7-2
Replace Hydraulic Reservoir Breather . . . . .	3-7-3
Change Engine Oil and Replace Filter . . . . .	3-7-4
Replace Final Fuel Filter. . . . .	3-7-5
<b>Maintenance—Every 1000 Hours</b>	
Clean, Pack, and Adjust Front Wheel Bearings—Non-Powered (S.N.—911129) . . . . .	3-8-1
Clean, Pack, and Adjust Front Wheel Bearings—Non-Powered (S.N. 911130—). . . . .	3-8-3
Change MFWD Front Wheel Planetary Housing Oil—If Equipped . . . . .	3-8-4
Change MFWD Front Axle Housing Oil—If Equipped . . . . .	3-8-5
Clean Engine Crankcase Ventilation Tube . . . . .	3-8-5
Change Transmission and Torque Converter Oil and Replace Filter. . . . .	3-8-6
Change Rear Axle Oil. . . . .	3-8-7
Replace Pilot Control Filter. . . . .	3-8-8
Check Engine Speed . . . . .	3-8-8
Change Hydraulic Reservoir Oil . . . . .	3-8-9
Replace Engine Air Cleaner Elements . . . . .	3-8-10
<b>Maintenance—Every 2000 Hours</b>	
Adjust Engine Valve Lash (Clearance) . . . . .	3-9-1
<b>Miscellaneous—Machine</b>	
External Service Brake Inspection . . . . .	4-1-1
Inspecting And Cleaning Dusty Secondary And Primary Element . . . . .	4-1-2
Check Receiver-Dryer—If Equipped . . . . .	4-1-3
Checking Coolant Hoses and Radiator. . . . .	4-1-3
Draining the Cooling System . . . . .	4-1-4
Filling the Cooling System . . . . .	4-1-5
Do Not Service Or Adjust Injection Nozzles Or Injection Pump . . . . .	4-1-5
Replace Engine Torsional Damper. . . . .	4-1-6
Draining Fuel Filter Sediment . . . . .	4-1-6
Precautions for Alternator and Regulator . . . . .	4-1-6
Handling, Checking And Servicing Batteries Carefully . . . . .	4-1-7
Replacing Batteries . . . . .	4-1-8
Removing Batteries . . . . .	4-1-9
Replacing Fuses. . . . .	4-1-10
Remove and Install Halogen Bulb. . . . .	4-1-12
Checking Neutral Start System. . . . .	4-1-12
Changing Loader Buckets . . . . .	4-1-13
Reversing Stabilizer Feet—310G, 310SG . . . . .	4-1-14
Changing Sideshift Backhoe Stabilizer Feet—315SG . . . . .	4-1-14
Adding Liquid Ballast to Front Tires—310G . . . . .	4-1-15
Adding Liquid Ballast to Front Tires—310SG and 315SG . . . . .	4-1-15
Welding on Machine. . . . .	4-1-16
Checking Ride Control Accumulator—If Equipped . . . . .	4-1-17
Discharge Ride Control System Hydraulic Pressure—If Equipped. . . . .	4-1-18
Discharge Pilot Control System Hydraulic Pressure—If Equipped. . . . .	4-1-19
Lowering Boom Without Electrical Power—For Machines With Pilot Controls. . . . .	4-1-20
Check Park Brake . . . . .	4-1-21
Bleeding Service Brakes. . . . .	4-1-22
Service Recommendations For STC <sup>®1</sup> Fittings . . . . .	4-1-24
Check and Adjust Engine Speed Control Linkage. . . . .	4-1-25
Adjusting Speed Control Lever Tension (S.N.—913416) . . . . .	4-1-26
Adjusting Speed Control Lever Tension (S.N. 913417—) . . . . .	4-1-27
Adjusting Pilot Control Wrist Rest —If Equipped . . . . .	4-1-27
Checking and Adjusting Toe-In (S.N.—911129) . . . . .	4-1-28
Checking and Adjusting Toe-In (S.N. 911130—). . . . .	4-1-29
Installing Teeth on Backhoe Bucket . . . . .	4-1-30
Do Not Service Control Valves, Cylinders, Pumps or Motors . . . . .	4-1-30
Hardware Torque Specifications. . . . .	4-1-31
Keep ROPS Installed Properly . . . . .	4-1-31
Unified Inch Bolt and Cap Screw Torque Values. . . . .	4-1-32
Metric Bolt and Cap Screw Torque Values . . . . .	4-1-33
<b>Miscellaneous—Operational Checkout</b>	
Operational Checkout Procedure . . . . .	4-2-1
Gauge and Indicator Check With Engine Off . . . . .	4-2-1

Continued on next page

	Page		Page
FNR, Neutral Start Circuit and Reverse		310SG and 315SG Backhoe Loader	
Warning Alarm Checks . . . . .	4-2-2	Dimensions . . . . .	4-6-15
Park Brake, Indicator Light, and Engine		310SG and 315SG Backhoe Loader . . . . .	4-6-20
Speed Control Linkage Checks . . . . .	4-2-3	310SG and 315SG Backhoe Loader Weight. . . . .	4-6-20
Brake System Checks . . . . .	4-2-3	310SG, 315SG Buckets . . . . .	4-6-21
Steering System Checks . . . . .	4-2-5	310SG And 315SG Backhoe Loader	
Hydraulic System Checks. . . . .	4-2-5	Lifting Capacities—Standard Dipperstick. . . . .	4-6-22
Pilot Control Operation Checks—If		310SG And 315SG Backhoe Loader	
Equipped . . . . .	4-2-11	Lifting Capacities—Extendible Dipperstick	
Check Operation Of Accessories (Engine		(Retracted) . . . . .	4-6-23
Stopped) . . . . .	4-2-13	310SG And 315SG Backhoe Loader	
Cab Component Checks. . . . .	4-2-13	Lifting Capacities—Extendible Dipperstick	
Miscellaneous Checks . . . . .	4-2-14	(Extended) . . . . .	4-6-24
<b>Miscellaneous—Troubleshooting</b>		<b>Miscellaneous—Crime Prevention Tips</b>	
Troubleshooting Procedure. . . . .	4-3-1	Help Prevent Crime . . . . .	4-7-1
Engine . . . . .	4-3-2	Record Construction Identification Numbers . . . . .	4-7-1
Electrical System . . . . .	4-3-6	Keep Proof of Ownership . . . . .	4-7-1
Gauges and Indicators . . . . .	4-3-9	Park Indoors Out of Sight. . . . .	4-7-1
Hydraulic System . . . . .	4-3-12	When Parking Outdoors . . . . .	4-7-2
Transmission . . . . .	4-3-14	Reduce Vandalism . . . . .	4-7-2
		Report Thefts Immediately . . . . .	4-7-3
<b>Miscellaneous—Storage</b>			
Prepare Machine For Storage . . . . .	4-4-1		
<b>Miscellaneous—Machine Numbers</b>			
Record Product Identification Number (PIN) . . . . .	4-5-1		
Record Engine Serial Number . . . . .	4-5-1		
Record Transmission Serial Number—			
Manual Shift . . . . .	4-5-1		
Record Transmission Serial			
Number—Powershift—(310SG, 315SG) . . . . .	4-5-1		
Record Rear Axle Housing Serial Number . . . . .	4-5-2		
Record (MFWD) Front Axle Housing			
Serial Number—If Equipped . . . . .	4-5-2		
<b>Miscellaneous—Specifications</b>			
Travel Speeds . . . . .	4-6-1		
Backhoe Loader Drain and Refill Capacities. . . . .	4-6-2		
310G Specifications . . . . .	4-6-3		
310G Backhoe Loader Dimensions . . . . .	4-6-4		
310G Backhoe Loader . . . . .	4-6-9		
310G Backhoe Loader Weight . . . . .	4-6-10		
310G Buckets. . . . .	4-6-10		
310G Backhoe Loader Lifting Capacities—			
Standard Dipperstick. . . . .	4-6-11		
310G Backhoe Loader Lifting			
Capacities—Extendible Dipperstick			
(Retracted) . . . . .	4-6-12		
310G Backhoe Loader Lifting			
Capacities—Extendible Dipperstick			
(Extended) . . . . .	4-6-13		
310SG and 315SG Specifications . . . . .	4-6-14		



# Safety—Safety Features

## Safety Features

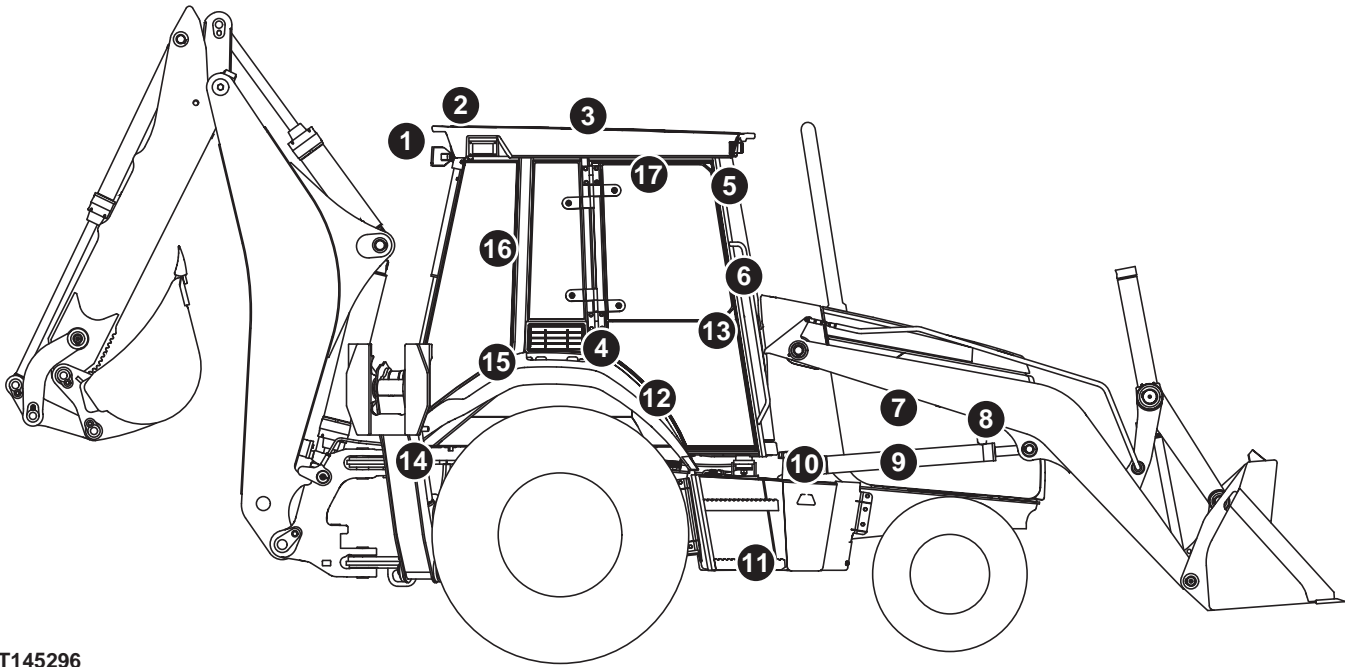

T145296

T145296 -JUN-05SEP01

Please remember, the **operator** is the key to preventing accidents.

1. **Headlights/Taillights.** Two front halogen driving/work lights and two rear halogen work lights.
2. **Signal/Warning Lights.** Roof mounted turning signal lights and warning lights for on-road use.
3. **ROPS Protection.** Certified rollover protection structure surrounds the operator. Integral roof provides overhead protection.
4. **Seat Position Sensor.** An audio/visual warning alerts operator when FNR is in forward/ reverse and the seat turned toward the backhoe position.
5. **Interior Rearview Mirror.** Offers the operator a view of activity behind him.
6. **Handholds.** Large and conveniently placed, make it easy to enter or exit the operator's station.
7. **Loader Boom Service Lock.** Provided for working on or around this machine with the boom raised.
8. **Engine Fan Guard.** A secondary engine fan guard inside engine compartment encloses rotating fan blades.
9. **Bypass Start Protection.** Shielding over the starter solenoid helps prevent dangerous bypass starting.
10. **Ground-Level Fueling, Daily Service Checks.** Ground-level fueling feature eliminates the need to climb on the machine to fuel it.
11. **Steps.** Wide, skid-resistant steps provide excellent footing for getting in/out of operator's station.
12. **Independent Parking/Secondary Brake.** Independent, electrically controlled, parking brake electrically engages when the engine is stopped.
13. **Neutral Start.** Prevents the engine from being started unless FNR control is in neutral.
14. **Backup Alarm.** Alerts bystanders when the machine is shifted into reverse.
15. **Seat Belt Retractors.** Seatbelt retractors help keep belts clean and convenient to use.
16. **Exceptional Visibility.** Views to either side and front or rear working tools are unrestricted.
17. **Operator Manual Holder.** A sealed manual holder keeps manual clean and dry.

TX03768.0000B8D -19-07SEP01-1/1

# Safety—General Precautions

## Recognize Safety Information

This is the safety alert symbol. When you see this symbol on your machine or in this manual, be alert for the potential of personal injury.

Follow the precautions and safe operating practices highlighted by this symbol.

A signal word — DANGER, WARNING, or CAUTION — is used with the safety alert symbol. DANGER identifies the most serious hazards.

On your machine, DANGER signs are red in color, WARNING signs are orange, and CAUTION signs are yellow. DANGER and WARNING signs are located near specific hazards. General precautions are on CAUTION labels.



T133555 -19-28AUG00

T133588 -19-28AUG00

TX03679,00016CC -19-21AUG00-1/1

## Follow Safety Instructions

Read the safety messages in this manual and on the machine. Follow these warnings and instructions carefully. Review them frequently. Keep safety signs in good condition. Replace missing or damaged safety signs. Be sure new equipment components and repair parts include the current safety signs. Replacement safety signs are available from your authorized John Deere dealer.

Be sure all operators of this machine understand every safety message. Replace operator's manual and safety labels immediately if missing or damaged.



T133556 -19-24AUG00

TX03679,00016F9 -19-28JAN03-1/1

## Operate Only If Qualified

Do not operate this machine unless you have read the operator's manual carefully and you have been qualified by supervised training and instruction.

Familiarize yourself with the job site and your surroundings before operating. Try all controls and

machine functions with the machine in an open area before starting to work.

Know and observe all safety rules that may apply to your work situation and your work site.

TX03679,00016FA -19-30OCT00-1/1

## Wear Protective Equipment

Guard against injury from flying pieces of metal or debris; wear goggles or safety glasses.

Wear close fitting clothing and safety equipment appropriate to the job.

Prolonged exposure to loud noise can cause impairment or loss of hearing. Wear suitable hearing protection such as earmuffs or earplugs to protect against objectionable or uncomfortable loud noises.

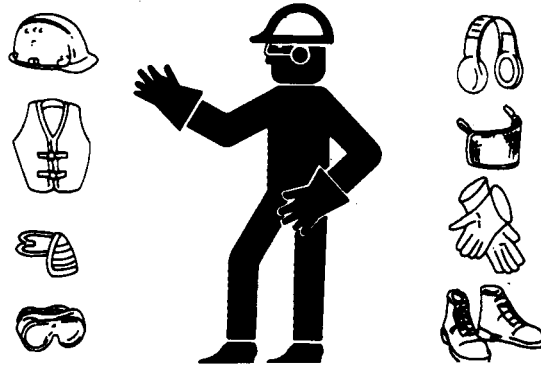

TS206 -JUN-23AUG88

TX03679,00016D0 -19-30OCT00-1/1

## Avoid Unauthorized Machine Modifications

Modifications of this machine, or addition of unapproved products or attachments, may affect machine stability or reliability, and may create a hazard for the operator or others near the machine. The installer of any modification which may affect the electronic controls of this machine is responsible for establishing that the modification does not adversely affect the machine or its performance.

Always contact an authorized dealer before making machine modifications that change the intended use, weight or balance of the machine, or that alter machine controls, performance or reliability.

TX03679,00016B7 -19-12MAY03-1/1

## Inspect Machine

Inspect machine carefully each day by walking around it before starting.

Keep all guards and shields in good condition and properly installed. Fix damage and replace worn or broken parts immediately. Pay special attention to hydraulic hoses and electrical wiring.



T8607AQ -JUN-18OCT88

TX03679,0001734 -19-25SEP00-1/1

## Stay Clear Of Moving Parts

Entanglements in moving parts can cause serious injury.

Stop engine before examining, adjusting or maintaining any part of machine with moving parts.

Keep guards and shields in place. Replace any guard or shield that has been removed for access as soon as service or repair is complete.

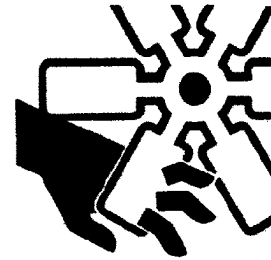

T133592 -JUN-12SEP01

TX03679,00016D2 -19-30OCT00-1/1

## Avoid High-Pressure Fluids

This machine uses a high-pressure hydraulic system. Escaping fluid under pressure can penetrate the skin causing serious injury.

**Never search for leaks with your hands.** Protect hands. Use a piece of cardboard to find location of escaping fluid. Stop engine and relieve pressure before disconnecting lines or working on hydraulic system.

**If hydraulic fluid penetrates your skin, see a doctor immediately. Injected fluid must be removed surgically within hours or gangrene may result.** Contact a knowledgeable medical source or the Deere & Company Medical Department in Moline, Illinois, U.S.A.

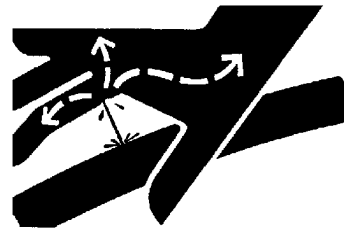

T133509 -JUN-31OCT00

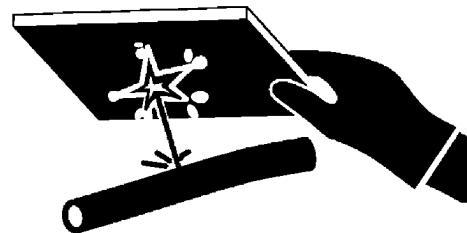

T133840 -JUN-20SEP00

TX03679,00016D3 -19-30OCT00-1/1

## Beware Of Exhaust Fumes

Prevent asphyxiation. Engine exhaust fumes can cause sickness or death.

If you must operate in a building, provide adequate ventilation. Use an exhaust pipe extension to remove the exhaust fumes or open doors and windows to bring outside air into the area.



T133546 -JUN-24AUG00

TX03679,00016D4 -19-14SEP00-1/1

## Prevent Fires

**Handle Fuel Safely:** Store flammable fluids away from fire hazards. Never refuel machine while smoking or when near sparks or flame.

**Clean Machine Regularly:** Keep trash, debris, grease and oil from accumulating in engine compartment, around fuel lines, hydraulic lines and electrical wiring. Never store oily rags or flammable materials inside a machine compartment.

**Maintain Hoses and Wiring:** Replace hydraulic hoses immediately if they begin to leak, and clean up any oil spills. Examine electrical wiring and connectors frequently for damage.

**Keep A Fire Extinguisher Available:** Always keep a multi-purpose fire extinguisher on or near the machine. Know how to use extinguisher properly.

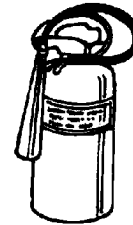
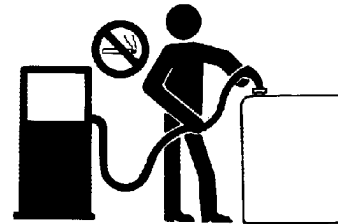

T133552 -JUN-14SEP00

T133553 -JUN-07SEP00

T133554 -JUN-07SEP00

TX03679,00016F5 -19-25SEP00-1/1

## Prevent Battery Explosions

Battery gas can explode. Keep sparks, lighted matches, and open flame away from the top of battery.

Never check battery charge by placing a metal object across the posts. Use a voltmeter or hydrometer.

Do not charge a frozen battery; it may explode. Warm battery to 16°C (60°F).



TS204 -JUN-23AUG88

TX03679,000174A -19-14SEP00-1/1

## Handle Chemical Products Safely

Exposure to hazardous chemicals can cause serious injury. Under certain conditions, lubricants, coolants, paints and adhesives used with this machine may be hazardous.

If uncertain about safe handling or use of these chemical products, contact your authorized dealer for a Material Safety Data Sheet (MSDS) or go to internet website <http://www.jdmsds.com>. The MSDS describes physical and health hazards, safe use procedures, and emergency response techniques for chemical substances. Follow MSDS recommendations to handle chemical products safely.

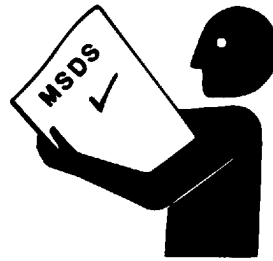

T133580 -JUN-25AUG00

TX03679,00016D7 -19-05AUG02-1/1

## Dispose Of Waste Properly

Improper disposal of waste can threaten the environment. Fuel, oils, coolants, filters and batteries used with this machine may be harmful if not disposed of properly.

Never pour waste onto the ground, down a drain, or into any water source.

Air conditioning refrigerants can damage the atmosphere. Government regulations may require using a certified service center to recover and recycle used refrigerants.

If uncertain about the safe disposal of waste, contact your local environmental or recycling center or your authorized dealer for more information.

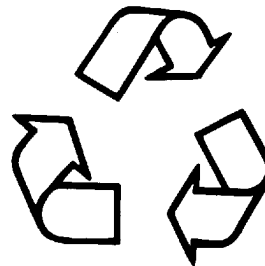

T133567 -JUN-25AUG00

TX03679,0001733 -19-17APR01-1/1

## Prepare For Emergencies

Be prepared if an emergency occurs or a fire starts.

Keep a first aid kit and fire extinguisher handy.

Keep emergency numbers for doctors, ambulance service, hospital, and fire department near your telephone.

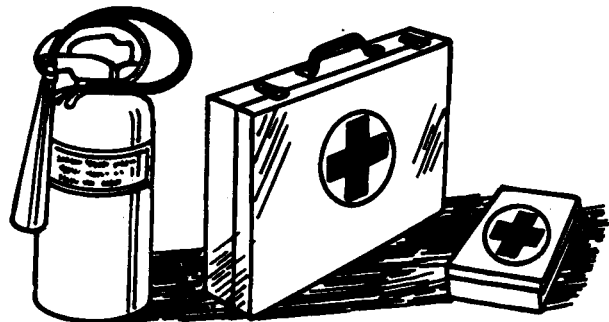

TS291 -JUN-23AUG88

TX03679,000174B -19-14SEP00-1/1



# Safety—Operating Precautions

## Use Steps And Handholds Correctly

Prevent falls by facing the machine when you get on and off. Maintain 3-point contact with steps and handrails. Never use machine controls as handholds.

Use extra care when mud, snow, or moisture present slippery conditions. Keep steps clean and free of grease or oil. Never jump when exiting machine. Never mount or dismount a moving machine.

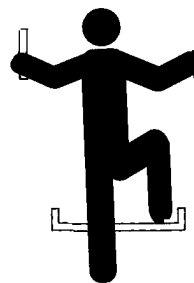

T133468 -JUN-30AUG00

TX03679,00016F2 -19-14SEP00-1/1

## Start Only From Operator's Seat

Avoid unexpected machine movement. Start engine only while sitting in operator's seat. Ensure all controls and working tools are in proper position for a parked machine.

Never attempt to start engine from the ground. Do not attempt to start engine by shorting across the starter solenoid terminals.



T133715 -JUN-07SEP00

TX03679,0001799 -19-02MAY01-1/1

## Use And Maintain Seat Belt

**Use seat belt when operating machine.** Remember to fasten seat belt when loading and unloading from trucks and during other uses.

Examine seat belt frequently. Be sure webbing is not cut or torn. Replace seat belt immediately if any part is damaged or does not function properly.

**The complete seat belt assembly should be replaced every three years, regardless of appearance.**



**USE  
SEAT  
BELT**

T133716 -19-14SEP00

TX03679,00016DD -19-17OCT00-1/1

## Prevent Unintended Machine Movement

**Always set the park lock brake switch to the “ON” position before leaving the operator’s seat for any reason.**

Be careful not to accidentally actuate steering, travel or other controls. Engage park brake and lower work equipment to the ground during work interruptions. Stop the engine before allowing anyone to approach the machine. Follow proper parking procedures before leaving the operator’s station.

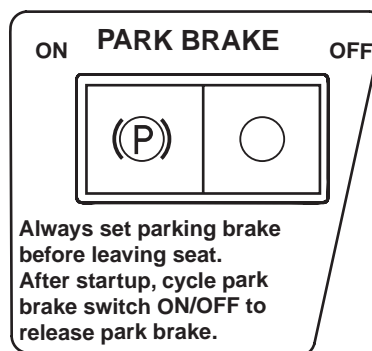

T147434 -19-26OCT01

TX03768,0000B8A -19-26OCT01-1/1

## Prevent Unintended Machine Movement—If Equipped With Pilot Controls

Be careful not to accidentally actuate control levers when co-workers are present. Always lock hydraulics on backhoe during work interruptions. Lock hydraulics before allowing anyone to approach machine.

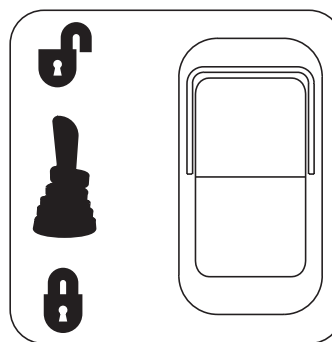

T164252 -UN-21JAN03

HG31779,00001D2 -19-23JAN03-1/1

## Avoid Work Site Hazards

**Avoid contact with gas lines, buried cables and water lines. Call utility line location services to identify all underground utilities before you dig.**

**Prepare work site properly.** Avoid operating near structures or objects that could fall onto the machine. Clear away debris that could move unexpectedly if run over.

**Avoid boom or attachment contact with overhead obstacles or overhead electrical lines.** Never move any part of machine or load closer than 3 m (10 ft) plus twice the line insulator length to overhead wires.

**Keep bystanders clear at all times.** Use barricades or a signal person to keep vehicles and pedestrians away. Use a signal person if moving machine in congested areas or where visibility is restricted. Always keep signal person in view. Coordinate hand signals before starting machine.

**Operate only on solid footing** with strength sufficient to support machine. Be especially alert working near embankments or excavations.

**Avoid working under over-hanging embankments or stockpiles** that could collapse on machine.

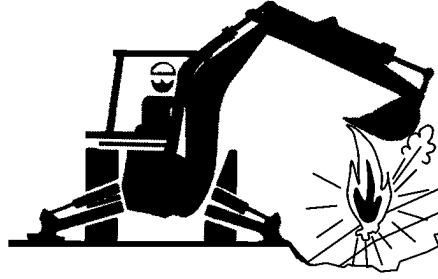

T147554 -JUN-01NOV01



T147555 -JUN-13DEC01

TX03768.0000BAA -19-21DEC01-1/1

## Keep Riders Off Machine

Only allow the operator on the machine. Keep riders off.

Riders on machine are subject to injury such as being struck by foreign objects and being thrown off of the machine. Riders also obstruct the operator's view resulting in the machine being operated in an unsafe manner.

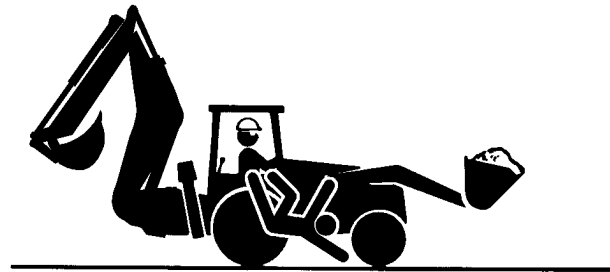

T148715 -JUN-06DEC01

TX03768.0000BAF -19-21NOV01-1/1

## Avoid Backover Accidents

**Before moving machine, be sure all persons are clear of the machine travel path.** Turn around and look directly for best visibility. Use mirror to assist in checking behind the machine. Keep windows and mirror clean and in good repair.

**Be certain backup warning alarm is working properly.**

**Use a signal person when backing if view is obstructed or when in close quarters.** Keep signal person in view at all times. Use prearranged hand signals to communicate.

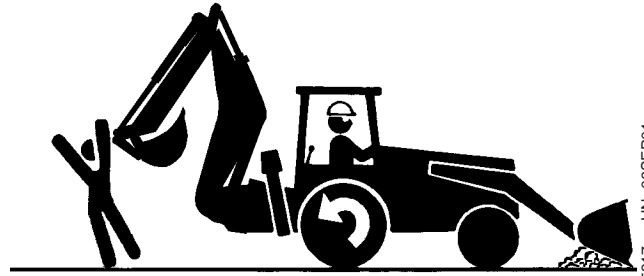

T145317 -UN-06SEP01

TX03768,0000B8B -19-06SEP01-1/1

## Avoid Machine Tipover

**Use seat belt at all times.**

**Do not jump if the machine tips.** You will be unlikely to jump clear and the machine may crush you.

**Load and unload from trucks or trailers carefully.** Be sure truck is wide enough and secured on a firm level surface. Use loading ramps and attach them properly to truck bed.

**Be careful on slopes.** Use extra care on soft, rocky or frozen ground because machine may slip sideways in these conditions.

**Ensure solid footing.** Use extra care when operating on stockpile materials, or near banks or excavations that may cave-in and cause machine to tip or fall.



**USE  
SEAT  
BELT**

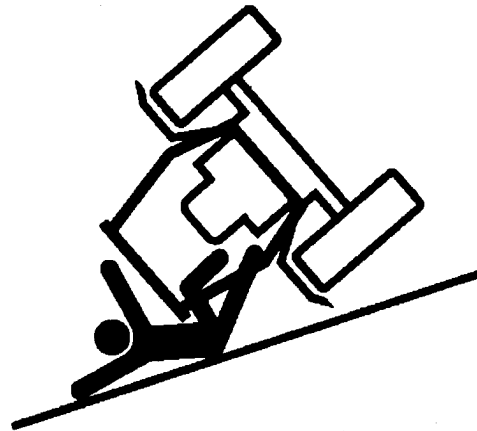

T147495 -19-26OCT01

TX03768,0000BA3 -19-26OCT01-1/1

## Add And Operate Attachments Safely

Always verify compatibility of attachments by contacting your authorized dealer. Adding unapproved attachments may affect machine stability or reliability, and may create a hazard for others near the machine.

Ensure that a qualified person is involved in attachment installation. Add guards to machine if operator protection is required or recommended. Verify that all connections are secure and attachment responds properly to controls.

Carefully read attachment manual and follow all instructions and warnings. In an area free of bystanders and obstructions, carefully operate attachment to learn its characteristics and range of motion.

TX03679,00016F0 -19-14SEP00-1/1

## Use Special Care When Operating

**Never use the loader to lift people.** Do not allow anyone to ride in the bucket or use the bucket as a work platform.

**Operate carefully with raised loads.** Raising the load reduces machine stability, especially on side slopes or soft terrain. Drive and turn slowly with a raised load.

**Ensure that objects in the bucket are secure.** Do not attempt to lift or carry objects that are too big or too long to fit inside the bucket unless secured with an adequate chain or other device. Keep bystanders away from raised loads.

**Be careful when lifting objects.** Never attempt to lift objects too heavy for your machine. Assure machine stability and hydraulic capability with a test lift before attempting other maneuvers. Use an adequate chain or sling and proper rigging techniques to attach and stabilize loads.

**Never lift an object above or near another person.**



T148749 -JUN-05DEC01

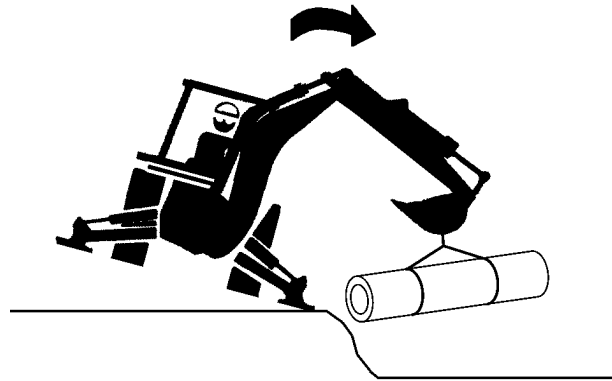

T147438 -JUN-26OCT01

TX03768,0000B70 -19-21DEC01-1/1

### Operating Or Traveling On Public Roads

Machines that work near vehicle traffic or travel slower than normal highway speeds must have proper lighting and markings to assure they are visible to other drivers.

Install additional lights, beacons, slow moving vehicle (SMV) emblems, or other devices and use as required to make the machine visible and identify it as a work machine. Check state and local regulations to assure compliance. Keep these devices clean and in working condition.

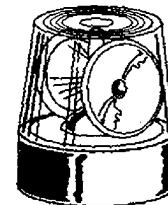
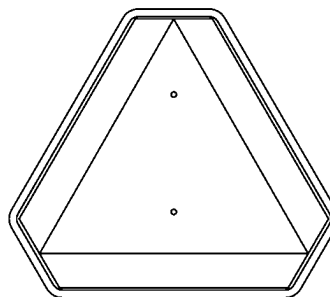

T141891 -JUN-22MAY01

TX03679,00017C8 -19-14JUN01-1/1

### Inspect and Maintain ROPS

A damaged roll-over protective structure (ROPS) should be replaced, not reused.

The protection offered by ROPS will be impaired if ROPS is subjected to structural damage, is involved in an overturn incident, or is in any way altered by welding, bending, drilling, or cutting.

If ROPS was loosened or removed for any reason, inspect it carefully before operating the machine again.

To maintain the ROPS:

- Replace missing hardware using correct grade hardware.
- Check hardware torque.
- Check isolation mounts for damage, looseness or wear; replace them if necessary.
- Check ROPS for cracks or physical damage.

TX03679,000179F -19-20APR01-1/1