

750C and 850C Crawler Dozer

OPERATOR'S MANUAL 750C and 850C Crawler Dozer OMT165719 K8 (ENGLISH)

CALIFORNIA
Proposition 65 Warning

Diesel engine exhaust and some of its constituents are known to the State of California to cause cancer, birth defects, and other reproductive harm.

If this product contains a gasoline engine:

 **WARNING**

The engine exhaust from this product contains chemicals known to the State of California to cause cancer, birth defects or other reproductive harm.

The State of California requires the above two warnings.

**Worldwide Construction
And Forestry Division**
(This manual replaces OMT162109)
LITHO IN U.S.A.

Introduction

Introduction

READ THIS MANUAL carefully to learn how to operate and service your machine correctly. Failure to do so could result in personal injury or equipment damage. This manual and safety signs on your machine may also be available in other languages. (See your John Deere dealer to order.)

THIS MANUAL SHOULD BE CONSIDERED a permanent part of your machine and should remain with the machine when you sell it.

MEASUREMENTS in this manual are given in both metric and customary U.S. unit equivalents. Use only correct replacement parts and fasteners. Metric and inch fasteners may require a specific metric or inch wrench.

RIGHT AND LEFT sides are determined by facing in the direction of forward travel.

WRITE PRODUCT IDENTIFICATION NUMBERS (P.I.N.) in the Machine Numbers chapter. Accurately

record all the numbers to help in tracing the machine should it be stolen. Your dealer also needs these numbers when you order parts. File the identification numbers in a secure place off the machine.

WARRANTY is provided as part of John Deere's support program for customers who operate and maintain their equipment as described in this manual. The warranty is explained on the warranty certificate which you should have received from your dealer.

This warranty provides you the assurance that John Deere will back its products where defects appear within the warranty period. In some circumstances, John Deere also provides field improvements, often without charge to the customer, even if the product is out of warranty. Should the equipment be abused, or modified to change its performance beyond the original factory specifications, the warranty will become void and field improvements may be denied. Setting fuel delivery above specifications or otherwise overpowering machines will result in such action.

CALIFORNIA PROPOSITION 65 WARNING

Diesel engine exhaust and some of its constituents are known to the State of California to cause cancer, birth defects and other reproductive harm.

Introduction



T8424BC -UN-15MAR95

T160591,IFC -19-11JUN96-2/3

Introduction



T8424BD -UN-15MAR95

T160591,IFC -19-11JUN96-3/3

Crawler Dozer Warranty

EMISSIONS CONTROL WARRANTY STATEMENT FOR NEW JOHN DEERE INDUSTRIAL EQUIPMENT (U.S. ONLY)

To determine if the engine in your machine qualifies for the additional warranties set forth below, look for the "Engine Information" label located on your engine. If you reside in the United States and the engine label states: "Engine conforms to US EPA regulations on heavy duty non road diesel cycle engines," you are entitled to the "U.S. Emission Control Warranty Statement." If you reside in California, and the engine label states: "Engine conforms to California regulations on heavy duty non road diesel cycle engines," you are entitled to the "California Emission Control Warranty Statement."

U.S. EMISSIONS CONTROL WARRANTY STATEMENT

Emissions control-related parts and components are warranted by John Deere for five years or 3000 hours of operation, whichever occurs first. John Deere further warrants that the engine covered by this warranty was designed, built, and equipped so as to conform at the time of sale with all U.S. emissions standards at the time of manufacture, and that it is free of defects in materials and workmanship which would cause it not to meet these standards within the period of five years or 3000 hours of operations, whichever occurs first.

Warranties stated on this certificate refer only to emissions-related parts and components of your engine. The complete machine warranty, less emissions-related parts and components, is provided separately as "John Deere "Secure Warranty" For New Industrial Products."

CALIFORNIA EMISSION CONTROL WARRANTY STATEMENT YOUR WARRANTY RIGHTS AND OBLIGATIONS

The California Air Resources Board (CARB) and John Deere are pleased to explain the emission control system on your new engine. In California, new heavy-duty engines must be designed, built and equipped to meet the State's stringent anti-smog standards. John Deere must warrant the emission control system on your engine for the periods of time listed below provided there has been no abuse, neglect, or improper maintenance of your machine.

Your emissions control system includes:

- Fuel Metering System
 - Fuel Injection System
- Air Induction System
 - Intake Manifold
 - Turbocharger System
 - Charge Air Cooling System
- Miscellaneous items used in Above Systems

Where a warrantable condition exists, i.e. failure due to defect in John Deere-supplied material and/or workmanship, John Deere will repair your heavy-duty engine at no cost to you including diagnosis, parts and labor.

JOHN DEERE'S WARRANTY COVERAGE:

The emission control system of your heavy-duty engine is warranted for five years or 3000 hours of operation, whichever occurs first. If any emission-related part on your engine is defective, the part will be repaired or replaced by John Deere. Warranties stated on this certificate refer only to emissions-related parts and components of your engine. The complete machine warranty, less emissions-related parts and components, is provided separately as the "John Deere "Secure Warranty" For New Industrial Products."

OWNER'S WARRANTY RESPONSIBILITIES:

As the heavy-duty engine owner, you are responsible for the performance of the required maintenance as outlined in the

Operator's Manual. John Deere recommends that you retain all receipts covering maintenance on your heavy-duty engine, but John Deere cannot deny warranty solely for the lack of receipts or for your failure to ensure the performance of all scheduled maintenance.

However, as the heavy-duty engine owner, you should be aware that John Deere may deny you warranty coverage if your heavy-duty engine has failed due to abuse, neglect, improper maintenance or unapproved modifications.

Your engine is designed to operate on diesel fuel only. Use of any other fuel may result in your engine no longer operating in compliance with California's emissions requirements.

You are responsible for initiating the warranty process. The CARB suggests that you present your machine to the nearest authorized John Deere dealer as soon as a problem is suspected. The warranty repairs should be completed by the service dealer as expeditiously as possible.

If you have any questions regarding your warranty rights and responsibilities, you should contact John Deere at 1-319-292-5400.

The warranty period begins on the date the machine is delivered to an ultimate purchaser, or when otherwise put into service. John Deere warrants to the ultimate purchaser and each subsequent purchaser that the engine is designed, built and equipped so as to conform with all applicable regulations adopted by the Air Resources Board, and that it is free from defects in materials and workmanship which would cause the failure of a warranted part.

Any warranted part which is scheduled for replacement as required maintenance by the operator's manual is warranted by John Deere for the period of time prior to the first scheduled replacement point for that part. If the part fails prior to the first scheduled replacement point, the part shall be repaired or replaced under the warranty. Any such part repaired or replaced under warranty is warranted for the remainder of the period prior to the first scheduled replacement point for that part.

Any warranted part which is not scheduled for replacement as required maintenance, or which is scheduled only for regular inspection to the effect of repairing or replacing as necessary, is warranted for the warranty period.

Repair or replacement of a warranted part will be performed at no charge to you by an authorized John Deere dealer. You will not be charged for diagnostic labor which leads to the determination that a warranted part is defective, if the diagnostic work is performed by a John Deere dealer.

John Deere is liable for damages to other engine components caused by failure under warranty of any warranted part.

Any replacement part may be used in the performance of any maintenance or repairs, and such use will not reduce the warranty obligations of John Deere. However, the use of add-on or modified parts are grounds for disallowing a warranty claim.

T107712 -19-26FEB97

Introduction

HELP!! HELP!! HELP!! HELP!!

We need your help to continually improve our technical publications. Please FAX or mail your comments, ideas and improvements.

SEND TO: John Deere Dubuque Works
P.O. Box 538
Attn: Publications Supervisor, Dept. 303
Dubuque, Iowa 52004-0538

FAX NUMBER: 319-589-5800

Ideas, Comments (Please State Page Number): _____

OVERALL, how would you rate the quality of "ALL" Manuals of this type provided to you? (Check one.)

	Poor		Fair		Good		Very Good		Excellent
1	2	3	4	5	6	7	8	9	10

Company Name _____
Address _____
Phone _____
FAX No. _____
Dealer Acct. No. _____

THANK YOU!

Contents

	Page		Page
Safety	05-1	Operator's Manual Holder	10-19
Safety Signs	06-1	Adjusting Seat	10-20
Operator's Station		Seat Belt	10-21
Display Monitor Gauges and Indicators	10-1	Break-In	
Monitor Display Window	10-2	Observe Engine Operation Closely	15-1
Select Button Operation	10-3	After the First 10 Hours	15-1
Engine Coolant Temperature Gauge	10-4	Between the First 50 to 100 Hours	15-1
Fuel Level Gauge	10-4	Pre-Start Inspection	
Engine Oil Pressure Gauge	10-4	Inspect Machine Daily Before Starting	20-1
STOP-Engine Indicator and Alarm	10-5	Operating the Engine	
Service Required Indicator	10-5	Check Instruments Before Starting	25-1
Engine Alternator Voltage Indicator	10-5	Starting the Engine	25-1
Engine Air Filter Restriction Indicator	10-6	Starting Fluid—Cold Weather Start Aid	25-3
Transmission Oil Temperature Hot Indicator ...	10-6	Using Booster Batteries—24-Volt System	25-5
Transmission Oil Filter Restriction Indicator ...	10-6	Using Coolant Heater—If Equipped	25-6
Hydraulic Oil Filter Restriction Indicator	10-6	Check Instruments After Starting	25-6
Return FNR to Neutral Indicator	10-7	Warm-Up Engine	25-6
Check Service Code Indicator	10-7	Engine Cold Weather Warm-Up	25-7
Ether Injection Indicator	10-7	Stalled Engine	25-7
Fasten Seat Belt Indicator	10-8	Stopping the Engine—Normal Shutdown	25-8
Transmission Oil Pressure Gauge	10-8	Driving the Machine	
Battery Disconnect Switch	10-8	Driving the Machine	30-1
Blade Control Lever	10-9	Operating Suggestions	30-1
Park Lock Levers	10-9	Extend Undercarriage Life	30-2
Engine Speed Lever—All Machines	10-10	Operating Park Lock Levers	30-3
Transmission Speed Lever—Lever Steer		Driving the Machine—Pedal Steer Machine ...	30-4
Machines	10-10	Driving the Machine—Lever Steer Machine ...	30-5
FNR Lever—Lever Steer Machine	10-11	Travel Speed	30-6
FNR Lever—Pedal Steer Machine	10-12	Operating Brake Pedal	30-6
Pedals—Lever Steer Machine	10-13	Stopping the Machine	30-7
Pedals—Pedal Steer Machine	10-13	Parking the Machine	30-8
Work Lights—If Equipped	10-14	Lock All Compartments	30-9
Air Conditioner and Heat	10-15	Operating the Machine	
Dome and Swivel Light	10-15	Blade Operation Tips	35-1
Mirror	10-16	Blade Control Lever—Operation	35-2
Door Latch	10-16	Determining Blade Pitch	35-3
Windows	10-17		
Cab Windows	10-18		
Windshield Wiper and Washer			
Controls—Cab	10-18		
Grease Gun—If Equipped	10-19		

Continued on next page

All information, illustrations and specifications in this manual are based on the latest information available at the time of publication. The right is reserved to make changes at any time without notice.

COPYRIGHT © 1998
DEERE & COMPANY
Moline, Illinois
All rights reserved
A John Deere ILLUSTRATION® Manual
Previous Editions
Copyright © 1997

Contents

Page	Page		
Changing Blade Pitch	35-4	Check and Adjust Fan Belt Tension—750C (S.N. —831315)	55-2
Changing Blade Angle—Mechanical Angle	35-5	Check and Adjust Compressor Belt Tension—If Equipped—750C (S.N. —831315)	55-3
Operating on Slopes.	35-5	Check Track Sag	55-4
Operating in Rough Terrain	35-6	Adjust Track Sag	55-5
Side-by-Side Dozing.	35-6	Check Air Restriction Indicator	55-7
Slot Dozing.	35-6	Maintenance—Every 10 Hours or Daily	
Tilt Dozer Ditching	35-6	Check Coolant Level	60-1
Backfilling.	35-7	Check Engine Oil Level—750C (S.N. — 831315)	60-2
Leveling a Stockpile	35-7	Check Engine Oil Level—750C (S.N. 831316—) and 850C	60-3
Moving Boulders.	35-8	Check Hydraulic Oil Level	60-4
Bench Cut	35-10	Check Transmission Oil Level	60-5
Brush Removal.	35-10	Lubricate Dozer Linkage	60-6
Tree Removal.	35-11	Lubricate All-Hydraulic Blade	60-7
Stump Removal	35-12	Maintenance—Every 50 Hours	
Transporting		Lubricate Left and Right Track Frame Pivot	65-1
Loading Machine on a Trailer	40-1	Lubricate Lift Cylinder Pivots	65-2
Towing	40-2	Lubricate Track Adjust Cylinder	65-3
Fuels and Lubricants		Maintenance—Every 250 Hours	
Diesel Fuel	45-1	Change Engine Oil and Filter Elements	75-1
Storing Fuel	45-1	Check Inner and Outer Final Drive Housings Oil Level	75-4
Fuel Tank	45-2	Check Radiator Coolant Level	75-5
Low Sulfur Diesel Fuel Conditioner.	45-2	Maintenance—Every 500 Hours	
Do Not Use Galvanized Containers	45-3	Check Coolant Conditioner	80-1
Diesel Engine Oil	45-4	Change Primary Fuel Filter—750C (S.N. — 831315)	80-2
Transmission, Hydraulic, and Hand Pump Reservoir Oil	45-5	Change Secondary Fuel Filter—750C (S.N. —831315).	80-3
Inner and Outer Final Drive Oil	45-6	Change Primary Fuel Filter—750C (S.N. 831316—)	80-4
Track Rollers, Front Idler, Carrier Roller and Track Frame Outer Pivot Oil	45-7	Change Secondary Fuel Filter—750C (S.N. 831316—)	80-5
Grease	45-7	Change Primary Fuel Filter—850C	80-6
Lubricant Storage	45-8	Change Secondary Fuel Filter—850C	80-7
Alternative and Synthetic Lubricants	45-8	Check Battery Electrolyte Level and Terminals	80-8
Mixing of Lubricants	45-9	Check Air Intake Hose	80-10
Periodic Maintenance		Maintenance—Every 1000 Hours	
Install Do Not Operate Tag.	50-1	Check Left and Right Track Frame Pivot Oil Level	85-1
Service Your Machine at Specified Intervals	50-1	Change Final Drive Oil	85-2
Check Hour Meter Regularly	50-2		
Use Correct Fuels and Lubricants	50-2		
Prepare Machine for Maintenance	50-2		
Maintenance and Repair Record Keeping System	50-5		
Oilscan Plus®, Coolscan Plus® and 3-Way Coolant Test Kit	50-6		
Maintenance and Repair Record Keeping System	50-7		
Maintenance—As Required			
Check and Adjust Alternator Belt Tension—750C (S.N. —831315)	55-1		

Continued on next page

Contents

Page	Page		
Clean Engine Crankcase Vent Tube	85-3	Check and Adjust Front	
Remove and Inspect Air Filter Elements	85-4	Crossbar-to-Crossbar Support and Main Frame	
Measure and Adjust Engine Valve		Clearances	90-30
Clearances—750C (S.N. —831315)	85-7	Adjusting Engine Speed Control Lever	90-31
Maintenance—Every 2000 Hours		Welding Procedure	90-31
Change Hydraulic Oil and Filter	86-1	Cleaning Cab Air Filter	90-32
Change Hydrostatic Transmission Oil		Cleaning Cab Air Filter—Interior	90-32
and Filter	86-2	Checking Fire Extinguisher—If Equipped	90-33
Measure and Adjust Engine Valve		Checking Air Conditioner Refrigerant	
Clearances—750C (S.N. 831316—)	86-4	Level—If Equipped	90-33
Measure and Adjust Engine Valve		Service Control Valves, Cylinders, Pumps	
Clearances—850C	86-6	and Motors	90-33
Check Engine Speeds	86-8	Engine Speed Adjustment—750C (S.N.	
		831316—) and 850C (S.N. —822867)	90-34
		Hardware Torque Specifications	90-35
		Checking Track Shoe Cap Screw Torque	90-36
		Checking Track Shoe Cap Screw Torque—	
		Master Link	90-37
		Metric Bolt and Cap Screw Torque Values	90-39
		Additional Metric Cap Screw Torque Values	90-40
		Service Metric Series Four Bolt Flange	
		Fitting	90-42
		Unified Inch Bolt and Cap Screw Torque	
		Values	90-43
		Checking Oil Lines and Fittings	90-44
		Service Recommendations for O-Ring Boss	
		Fittings	90-45
		Service Recommendations for Flat Face	
		O-Ring Seal Fittings	90-47
		Service Recommendations for Inch	
		Series Four Bolt Flange Fittings	90-48
		Operational Checkout	
		Operational Checkout	95-1
		Battery Disconnect Switch, Relays,	
		Gauges, Monitor and Transmission	
		Controller	95-1
		Park Lock, Park Brake, and Start Checks	95-5
		General Driving and Transmission Checks	95-7
		Undercarriage Checks	95-17
		Accessories and Cab Components	95-19
		Troubleshooting	
		Using Troubleshooting Charts	100-1
		Engine	100-1
		Electrical System	100-15
		Hydraulic System	100-22
		Hydrostatic Transmission	100-25
		Brake System	100-26
		Air Conditioning	100-27
		Transmission Controller Service Codes	100-28

Continued on next page

Page

Engine Controller Service Codes—850C
(S.N. 822868—) 100-35

Storage

Prepare Machine for Storage 105-1
Lock All Compartments 105-2
Monthly Storage Procedure 105-3

Machine Numbers

Record Product Identification Number (PIN) . . 110-1
Record Engine Serial Number 110-1
Record Winch Serial Number—If Equipped . . . 110-1
Record C-Frame or Pushbeam Serial
Number 110-1
Record Transmission Serial Numbers. 110-2

Specifications

750C Specifications 115-1
750C General Specifications 115-4
750C Dimensions. 115-6
750C WT Dimensions. 115-10
750C LGP Dimensions. 115-12
850C Specifications 115-14
850C General Specifications 115-17
850C Dimensions. 115-19
850C WT Dimensions. 115-23
850C LGP Dimensions. 115-25

Crime Prevention Tips

Help Prevent Crime 120-1
Record Identification Numbers 120-1
Keep Proof of Ownership 120-1
Park Indoors Out of Sight. 120-1
When Parking Outdoors 120-2
Reduce Vandalism 120-2
Report Thefts Immediately 120-3

Checklists CLIS-1

John Deere Service Keeps You On the Job

At Your Service When You Need It IBC-1

Safety

750C and 850C Crawler Dozer

John Deere Crawler Safety Features

Please remember, the **operator is the key** to preventing accidents.

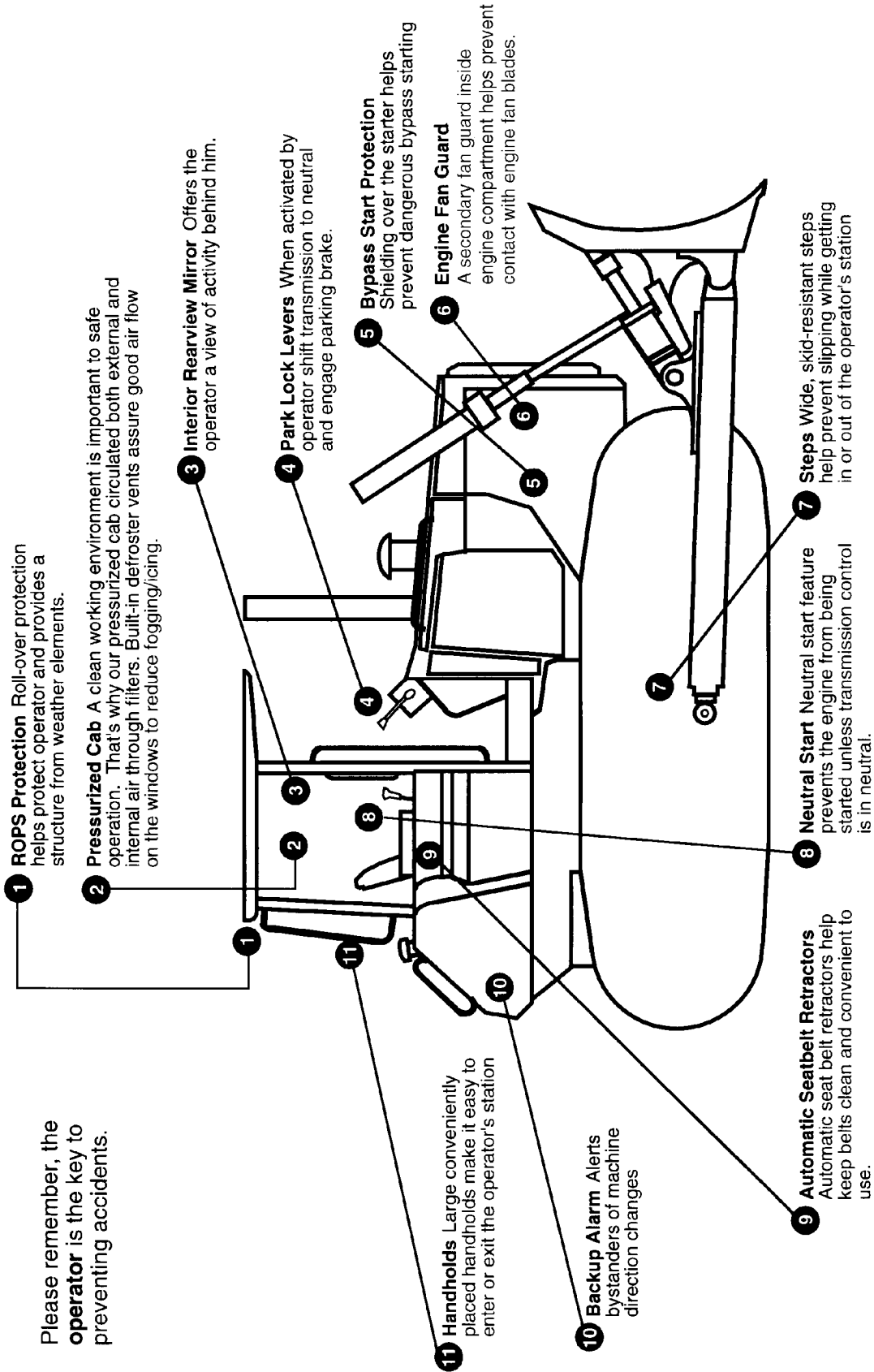

T108893 -19-06APR97

TX,05,BG996 -19-03APR97-1/1

Recognize Safety Information

This is the safety-alert symbol. When you see this symbol on your machine or in this manual, be alert to the potential for personal injury.

Follow recommended precautions and safe operating practices.



DX,ALERT -19-03MAR93-1/1

TS1389 -UN-07DEC88

Understand Signal Words

A signal word—DANGER, WARNING, or CAUTION—is used with the safety-alert symbol. DANGER identifies the most serious hazards.

DANGER or WARNING safety signs are located near specific hazards. General precautions are listed on CAUTION safety signs. CAUTION also calls attention to safety messages in this manual.



DX,SIGNAL -19-03MAR93-1/1

TS187 -19-30SEP88

Follow Safety Instructions

Carefully read all safety messages in this manual and on your machine safety signs. Keep safety signs in good condition. Replace missing or damaged safety signs. Be sure new equipment components and repair parts include the current safety signs. Replacement safety signs are available from your John Deere dealer.

Learn how to operate the machine and how to use controls properly. Do not let anyone operate without instruction.

Keep your machine in proper working condition. Unauthorized modifications to the machine may impair the function and/or safety and affect machine life.

If you do not understand any part of this manual and need assistance, contact your John Deere dealer.



DX,READ -19-03MAR93-1/1

TS201 -UN-23AUG88

Avoid Injury from Rollover Accidents

Wear Your Seat Belt

Do Not Attempt to Jump Clear of Tipping Machine--Serious or Fatal Crushing Injuries Will Result

Machine Will Tip Over Faster Than You Can Jump Free

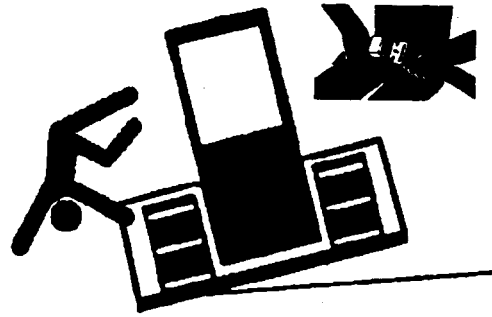

T7860AQ -JUN-09NOV92

To avoid roll-overs:

Be careful when operating on a slope.

Balance load so weight is evenly distributed and load is stable.

Keep blade close to ground to aid visibility and lower center of gravity.

Reduce speed before turning.

Know capacity of machine. Do not overload.

Be careful when operating near edge of an excavation, trench, drop-off, or trailer when loading or unloading.

Read and understand operating instructions in this operator's manual.

TX,05,RR,A1 -19-11JUN96-1/1

Avoid Injury from Backover Accidents

Before Moving Machine, Be Sure All Persons Are Clear of Area

Always Be Alert for Bystanders Moving into the Work Area. Use Horn or Other Signal to Warn Bystanders Before Moving Machine

When Using a Signal Person, Keep Person in View at All Times, Be Sure Signal Person Is Clear Before Backing Up

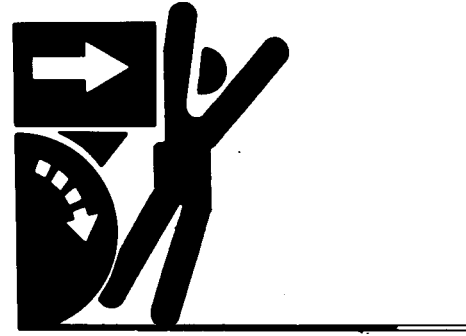

TT7241AY -UN-21FEB90

To avoid backover accidents:

Always look around before you back up. Be sure that everyone is in the clear.

Keep reverse warning alarm in working condition.

Use a signal person when backing up if view is obstructed. Always keep signal person in view.

Learn the meaning of all flags, signs, and markings used on the job and who has the responsibility for signaling.

Keep windows, mirrors, and lights clean and in good condition.

Dust, heavy rain, fog, etc., can reduce visibility. As visibility decreases, reduce speed and use proper lighting.

Read and understand operating instructions in this operator's manual.

TX,05,DY73 -19-16OCT96-1/1

Avoid Injury from Rollaway Accidents

To Prevent Rollaway, Always Make Sure Machine Is Properly Secured Before Leaving Operator's Seat

Death or Serious Injury May Result If You Attempt to Mount or Stop a Moving Machine

T118019

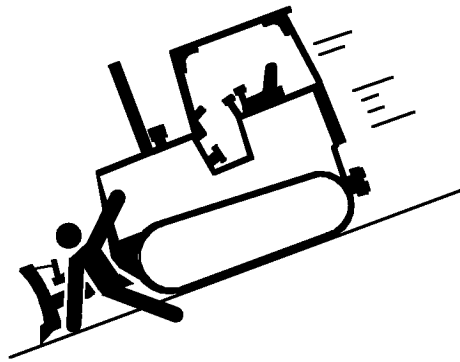

T118019 -JUN-01DEC98

To avoid rollaways:

Select level ground when possible to park machine.

Park a reasonable distance from other machines.

Place FNR control lever in neutral "N" and park lock levers in locked position.

Lower blade to ground and block tracks.

Stop the engine.

Read and understand operating instructions in this operator's manual.

TX,05,RR,A3 -19-20MAY96-1/1

Avoid Injury from:

**Loading Machine on a Trailer,
Fastening Machine to Trailer,
Unloading Machine from Trailer**

**Always Use Caution When Loading
and Unloading Machines on a
Trailer**

**Always Know and Follow the
Recommended Procedures for the
Machine Because All Machines Are
Not Loaded, Fastened and Unloaded
the Same Way.**

**Always Keep Bystanders Clear of
the Area**

To avoid injury:

Keep trailer bed clean.

Park trailer on a firm, hard, level surface that will not give way under weight of machine.

Put chock blocks against truck wheels.

Use a ramp or loading dock. Ramps must be strong enough to adequately handle the load and have a low angle and correct height.

Fasten seat belt before starting engine.

Fasten chains or cables to machine tracks or track chain links. Do not place chains or cables against hydraulic lines or hoses.

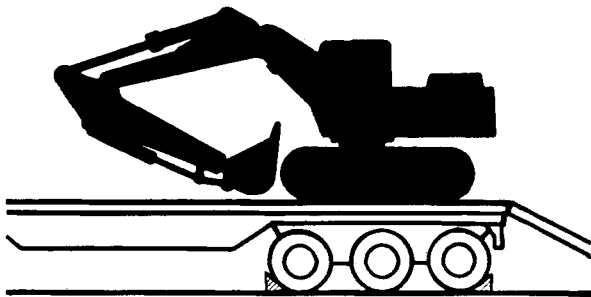
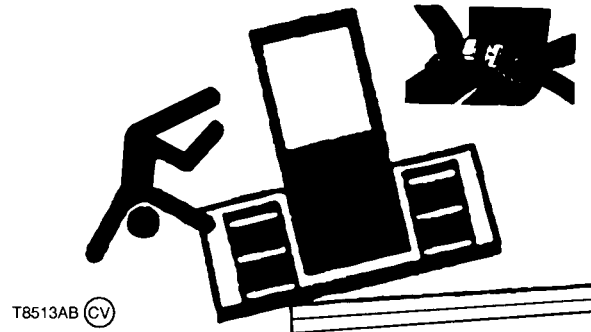

T8513AB -JUN-28JUN95

T7405BJ -JUN-29NOV90

TX,05,DY74 -19-16OCT96-1/1

Inspect Machine

Inspect your machine carefully each day by walking around it before starting. See Pre-Start Inspection chapter.



T6607AQ -UN-18OCT88

TX,05,RR,A5 -19-20MAY96-1/1

Use Handholds and Steps

Falling is a major cause of personal injury.

When you get on and off machine, always maintain a three point contact with steps and handrails and face the machine. Do not use any controls as handholds.

Never jump on or off the machine. Never mount or dismount a moving machine.

Be careful of slippery conditions on platforms, steps, and handrails when leaving the machine.



T6981AN -UN-15JUN89

TX,05,RR,A6 -19-20MAY96-1/1

Prevent Machine Runaway

Avoid possible injury or death from machine runaway.

Do not start engine by shorting across starter terminals. Machine may start in gear if normal circuitry is bypassed.

NEVER start engine while standing on ground. Start engine only from operator's seat, with park lock levers UP and transmission in neutral.

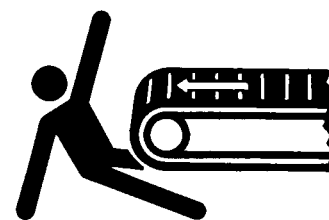

T6607AO -UN-18OCT88

TX,05,RR5105 -19-13MAR96-1/1

Use Seat Belt Properly

Use a seat belt to minimize chance of injury from an accident such as an overturn.

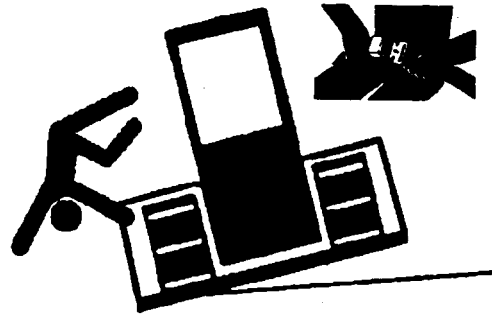

T7860AQ -JUN-09NOV92

TX,05,RR,A7 -19-20MAY96-1/1

Maintain Seat Belt

IMPORTANT: Complete seat belt assembly should be replaced after three years of usage, regardless of appearance.

Between replacement intervals:

- Carefully examine buckle, webbing, and attaching hardware.
- Be sure that attaching hardware is in place. Tighten, if necessary.
- Replace seat belt if it does not operate properly, or if it is damaged, worn, or deteriorated. See Seat Belt in Operator's Station chapter.

TX,05,RR,A8 -19-20MAY96-1/1

Secondary Exits

Machines equipped with cabs are equipped with secondary exits. For additional secondary exit information, see Windows in Operator's Station chapter.

TX,05,RR,A9 -19-20MAY96-1/1

Operating on Slopes

Avoid side slope travel whenever possible. The danger of tipping is always present.

In steep slope operation, do not allow engine to overspeed. Select proper gear speed before starting down slope.

Grade of slope you attempt will be limited by such factors as ground condition and load.

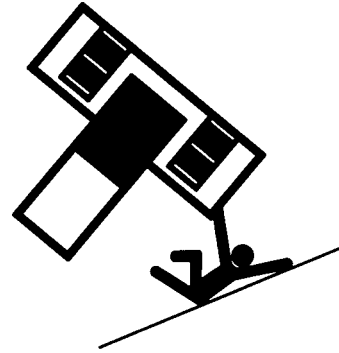

T8404AF -UN-14FEB95

TX,05,RR,A10 -19-11JUN96-1/1

Park Machine Safely

Before working on the machine:

1. Park machine on a level surface.
2. Lower blade to ground.
3. Move FNR lever to neutral.
4. Move park lock levers to locked position.
5. Run engine at 1/2 speed no load for 2 minutes.
6. Move speed control lever to slow idle position.
7. Turn key switch OFF to stop engine and remove key.
8. Release hydraulic pressure by moving control lever until equipment does not move.
9. Turn battery disconnect switch to off position.
10. Allow engine to cool.

TX,05,RR,A11 -19-11JUN96-1/1

Safety

Keep Riders Off Machine

Only allow the operator on the machine. Keep riders off.

Riders on machine are subject to injury such as being struck by foreign objects and being thrown off of the machine. Riders also obstruct the operator's view resulting in the machine being operated in an unsafe manner.

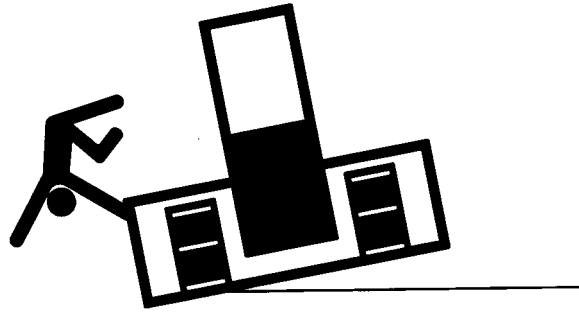

TS390AZ -JUN-31JAN95

TX,05,RR4837 -19-31MAR95-1/1

Handle Fuel Safely—Avoid Fires

Handle fuel with care: it is highly flammable. Do not refuel the machine while smoking or when near open flame or sparks.

Always stop engine before refueling machine. Fill fuel tank outdoors.

Prevent fires by keeping machine clean of accumulated trash, grease, and debris. Always clean up spilled fuel.



TS202 -JUN-23AUG88

DX,FIRE1 -19-03MAR93-1/1

Handle Fluids Safely—Avoid Fires

Store flammable fluids away from fire hazards. Do not incinerate or puncture pressurized containers.

Make sure machine is clean of trash, grease, and debris.

Do not store oily rags; they can ignite and burn spontaneously.



TS227 -JUN-23AUG88

TX,05,RR,A12 -19-11JUN96-1/1