

330CLC and 370C Excavator Repair

TECHNICAL MANUAL 330CLC and 370C Excavator Repair TM1927 05DEC01 (ENGLISH)

For complete service information also see:

330CLC and 370C Excavator Operation and Test	TM1926
POWERTECH® 8.1 L (6081) Diesel Engine Repair.....	CTM86
POWERTECH® 8.1 L (6081) Diesel Engine Operation and Diagnostics.....	CTM134
POWERTECH® 8.1 L (6081) Diesel Engine Level 9 Electronic Fuel Systems With Denso In-Line Pump	CTM255
Alternators and Starting Motors.....	CTM77
Undercarriage Appraisal Manual	SP326

**Worldwide Construction
And Forestry Division**
LITHO IN U.S.A.

Introduction

Foreword

This manual is written for an experienced technician. Essential tools required in performing certain service work are identified in this manual and are recommended for use.

Live with safety: Read the safety messages in the introduction of this manual and the cautions presented throughout the text of the manual.

 This is the safety-alert symbol. When you see this symbol on the machine or in this manual, be alert to the potential for personal injury.

Technical manuals are divided in two parts: repair and operation and tests. Repair sections tell how to repair the components. Operation and tests sections help you identify the majority of routine failures quickly.

Information is organized in groups for the various components requiring service instruction. At the beginning of each group are summary listings of all applicable essential tools, service equipment and tools, other materials needed to do the job, service parts kits, specifications, wear tolerances, and torque values.

Technical Manuals are concise guides for specific machines. They are on-the-job guides containing only the vital information needed for diagnosis, analysis, testing, and repair.

Fundamental service information is available from other sources covering basic theory of operation, fundamentals of troubleshooting, general maintenance, and basic type of failures and their causes.

DX, TMIFC -19-29SEP98-1/1

Introduction

Technical Information Feedback Form

We need your help to continually improve our technical publications. Please copy this page and FAX or mail your comments, ideas and improvements.

SEND TO: John Deere Dubuque Works
P.O. Box 538
Attn: Publications Supervisor, Dept. 303
Dubuque, IA 52004-0538

FAX NUMBER: 563-589-5800

Ideas, Comments (Please State Page Number):
[Multiple horizontal lines for text entry]

OVERALL, how would you rate the quality of this publication? (Check one)

1 Poor 2 3 Fair 4 5 Good 6 7 Very Good 8 9 Excellent 10

Company Name:
Technician Name:
Address:
Phone:
Fax No.:
Dealer Acct. No.:

THANK YOU!

Introduction

Contents

SECTION 00—General Information

- Group 0001—Safety
- Group 0003—Torque Values

00

SECTION 01—Tracks

- Group 0130—Track System

01

SECTION 02—Axles and Suspension Systems

- Group 0250—Axle Shaft, Bearings, and Reduction Gears
- Group 0260—Hydraulic System

02

SECTION 04—Engine

- Group 0400—Removal and Installation

SECTION 05—Engine Auxiliary Systems

- Group 0510—Cooling System
- Group 0520—Intake System
- Group 0560—External Fuel Supply Systems

04

SECTION 08—Splitter Drive

- Group 0851—Gears, Shafts and Bearings

05

SECTION 17—Frame or Supporting Structure

- Group 1740—Frame Installation
- Group 1749—Chassis Weights

SECTION 18—Operator's Station

- Group 1800—Removal and Installation
- Group 1810—Operator Enclosure
- Group 1821—Seat and Seat Belt
- Group 1830—Heating and Air Conditioning

08

SECTION 33—Excavator

- Group 3302—Buckets
- Group 3340—Frames
- Group 3360—Hydraulic System

17

SECTION 43—Swing or Pivoting System

- Group 4350—Mechanical Drive Elements
- Group 4360—Hydraulic System

18

SECTION 99—Dealer Fabricated Tools

- Group 9900—Dealer Fabricated Tools

33

All information, illustrations and specifications in this manual are based on the latest information available at the time of publication. The right is reserved to make changes at any time without notice.

43

COPYRIGHT © 2001
DEERE & COMPANY
Moline, Illinois
All rights reserved
A John Deere ILLUSTRATION® Manual

Contents

00

01

02

04

05

08

17

18

33

43

Contents

99

INDX

Contents

99

INDX

Section 00 General Information

Contents

	Page
Group 0001—Safety	00-0001-1
Group 0003—Torque Values	
Unified Inch Bolt and Cap Screw Torque Values	00-0003-1
Metric Bolt and Cap Screw Torque Values	00-0003-2
Additional Metric Cap Screw Torque Values	00-0003-3
Check Oil Lines And Fittings	00-0003-5
Service Recommendations for O-Ring Boss Fittings	00-0003-6
Service Recommendations for Flat Face O-Ring Seal Fittings	00-0003-8
Service Recommendations for 37° Flare and 30° Cone Seat Connectors	00-0003-9
Service Recommendations For Flared Connections—Straight or Tapered Threads	00-0003-10
Service Recommendations For Inch Series Four Bolt Flange Fittings	00-0003-11
Service Recommendations for Metric Series Four Bolt Flange Fitting	00-0003-12

Contents

00

Follow Safe Procedures

Unsafe work practices are dangerous. Understand service procedure before doing work; do not attempt shortcuts.



TS231 -19-07OCT88

TX,05,FF1611 -19-14JUN90-1/1

Prepare for Emergencies

Be prepared if a fire starts.

Keep a first aid kit and fire extinguisher handy.

Keep emergency numbers for doctors, ambulance service, hospital, and fire department near your telephone.

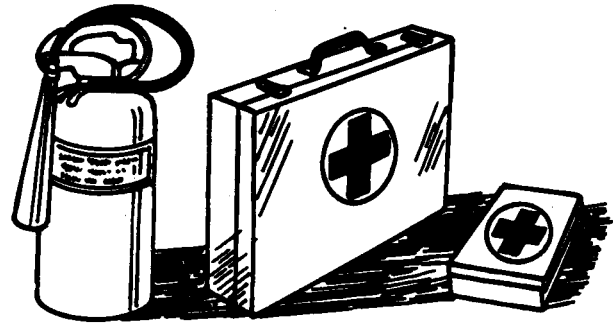

TS291 -UN-23AUG88

DX,FIRE2 -19-03MAR93-1/1

Handle Fluids Safely—Avoid Fires

Handle fuel with care; it is highly flammable. Do not refuel the machine while smoking or when near open flame or sparks. Always stop engine before refueling machine. Fill fuel tank outdoors.



TS202 -UN-23AUG88

TX,05,FF1622 -19-14JUN90-1/2

Store flammable fluids away from fire hazards. Do not incinerate or puncture pressurized containers.

Make sure machine is clean of trash, grease, and debris.

Do not store oily rags; they can ignite and burn spontaneously.



TS227 -UN-23AUG88

TX,05,FF1622 -19-14JUN90-2/2

Safety

Prevent Battery Explosions

Keep sparks, lighted matches, and open flame away from the top of battery. Battery gas can explode.

Never check battery charge by placing a metal object across the posts. Use a volt-meter or hydrometer.

Do not charge a frozen battery; it may explode. Warm battery to 16°C (60°F).



TS204 -JUN-23AUG88

DX.SPARKS -19-03MAR93-1/1

Handle Chemical Products Safely

Direct exposure to hazardous chemicals can cause serious injury. Potentially hazardous chemicals used with John Deere equipment include such items as lubricants, coolants, paints, and adhesives.

A Material Safety Data Sheet (MSDS) provides specific details on chemical products: physical and health hazards, safety procedures, and emergency response techniques.

Check the MSDS before you start any job using a hazardous chemical. That way you will know exactly what the risks are and how to do the job safely. Then follow procedures and recommended equipment.

(See your John Deere dealer for MSDS's on chemical products used with John Deere equipment.)



TS1132 -JUN-26NOV90

DX.MSDS.NA -19-03MAR93-1/1

Safety

Prevent Acid Burns

Sulfuric acid in battery electrolyte is poisonous. It is strong enough to burn skin, eat holes in clothing, and cause blindness if splashed into eyes.

Avoid the hazard by:

1. Filling batteries in a well-ventilated area.
2. Wearing eye protection and rubber gloves.
3. Avoiding breathing fumes when electrolyte is added.
4. Avoiding spilling or dripping electrolyte.
5. Use proper jump start procedure.

If you spill acid on yourself:

1. Flush your skin with water.
2. Apply baking soda or lime to help neutralize the acid.
3. Flush your eyes with water for 15—30 minutes. Get medical attention immediately.

If acid is swallowed:

1. Do not induce vomiting.
2. Drink large amounts of water or milk, but do not exceed 2 L (2 quarts).
3. Get medical attention immediately.

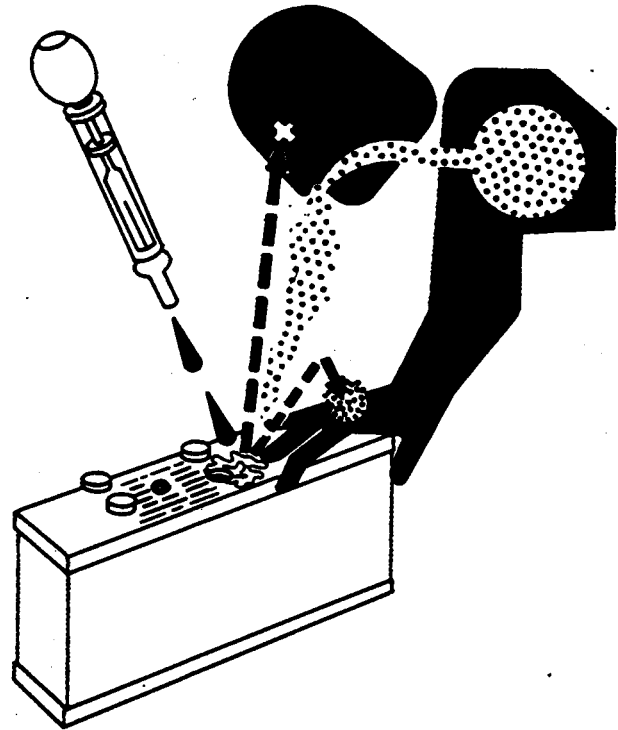

00
0001
3

TS203 -UN-23AUG88

DX,POISON -19-21APR93-1/1

00
0001
4

Avoid High-Pressure Fluids

Escaping fluid under pressure can penetrate the skin causing serious injury.

Avoid the hazard by relieving pressure before disconnecting hydraulic or other lines. Tighten all connections before applying pressure.

Search for leaks with a piece of cardboard. Protect hands and body from high pressure fluids.

If an accident occurs, see a doctor immediately. Any fluid injected into the skin must be surgically removed within a few hours or gangrene may result. Doctors unfamiliar with this type of injury should reference a knowledgeable medical source. Such information is available from Deere & Company Medical Department in Moline, Illinois, U.S.A.

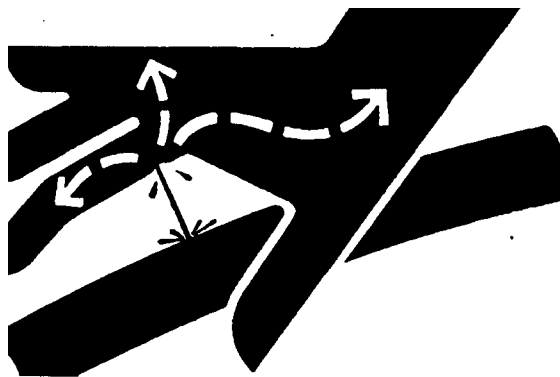

X9811 -UN-23AUG88

DX,FLUID -19-03MAR93-1/1

Warn Others of Service Work

Unexpected machine movement can cause serious injury.

Before performing any work on the machine, attach a "Do Not Operate" tag on the right control lever.

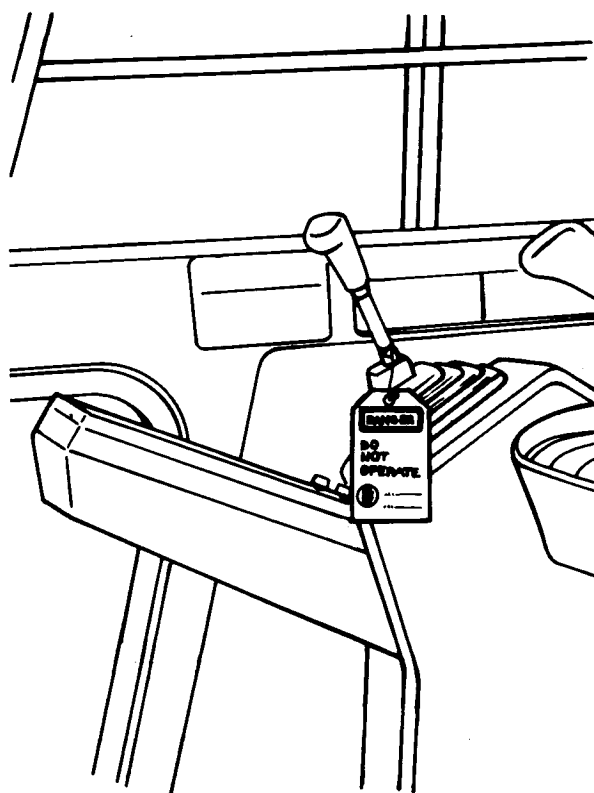

T7273AP -UN-08JUN90

TX,05,RR,566 -19-23JUL91-1/1

Park Machine Safely

Before working on the machine:

- Park machine on a level surface.
- Lower bucket to the ground.
- Turn auto-idle switch off.
- Run engine with engine RPM dial at 1/3 position for 2 minutes.
- Move engine RPM dial to slow idle position.
- Turn key switch to OFF. Remove key from switch.
- Pull pilot control shut-off lever to locked position.
- Allow engine to cool.

TX,05,DH5002 -19-28MAY96-1/1

Support Machine Properly

Always lower the attachment or implement to the ground before you work on the machine. If you must work on a lifted machine or attachment, securely support the machine or attachment. If left in a raised position, hydraulically supported devices can settle or leak down.

Do not support the machine on cinder blocks, hollow tiles, or props that may crumble under continuous load. Do not work under a machine that is supported solely by a jack. Follow recommended procedures in this manual.

When implements or attachments are used with a tractor, always follow safety precautions listed in the implement operator's manual.

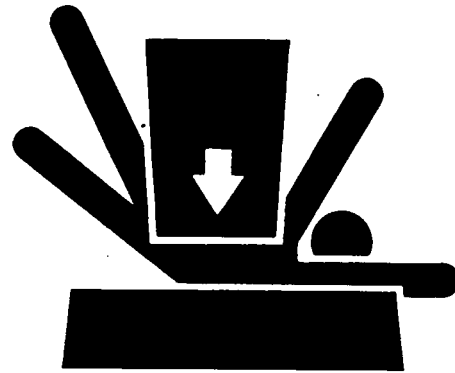

TS229 -UN-23AUG88

DX,LOWER -19-17FEB99-1/1

Operate Only from Operator's Seat

Avoid possible injury or machine damage. Do not start engine by shorting across starter terminals.

NEVER start engine while standing on ground. Start engine only from operator's seat.

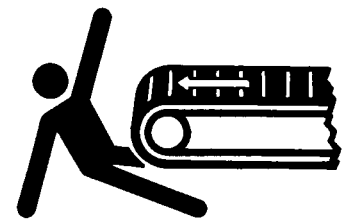

T6607AO -UN-18OCT88

TX,05,FF1615 -19-14JUN90-1/1

00
0001
6

Stay Clear of Moving Parts

Entanglements in moving parts can cause serious injury.
To prevent accidents, use care when working around rotating parts.

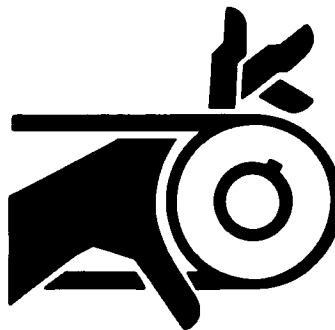

T7273AS -UN-08JUN90

TX,05,RR,572 -19-12JUN90-1/1

Avoid Power Lines

Serious injury or death can result from contact with electric lines.

Never move any part of the machine or load closer to electric line than 3 m (10 ft) plus twice the line insulator length.



T7273AD -UN-08JUN90

TX,05,RR,594 -19-12JUN90-1/1

Use Handholds and Steps

Falling is one of the major causes of personal injury.

When you get on and off the machine, always maintain a three point contact with the steps and handrails and face the machine. Do not use any controls as handholds.

Never jump on or off the machine. Never mount or dismount a moving machine.

Be careful of slippery conditions on platforms, steps, and handrails when leaving the machine.



T6981AN -UN-15JUN89

TX,05,DH832 -19-16MAR92-1/1

Keep Riders Off Machine

Only allow the operator on the machine. Keep riders off.

Riders on machine are subject to injury such as being struck by foreign objects and being thrown off the machine. Riders also obstruct the operator's view resulting in the machine being operated in an unsafe manner.



T7273AH -UN-08JUN90

TX,05,RR,560 -19-05OCT90-1/1

Move and Operate Machine Safely

Bystanders can be run over. Know the location of bystanders before moving, swinging, or operating the machine.

Always keep the travel alarm in working condition. It warns people when the machine starts to move.

Use a signal person when moving, swinging, or operating the machine in congested areas. Coordinate hand signals before starting the machine.

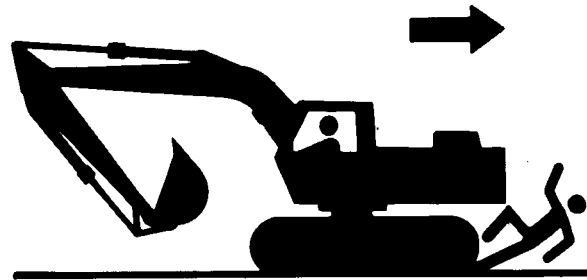

T7273AL -UN-08JUN90

TX,05,FF1806 -19-05OCT90-1/1

Wear Protective Clothing

Wear close fitting clothing and safety equipment appropriate to the job.

Operating equipment safely requires the full attention of the operator. Do not wear radio or music headphones while operating machine.

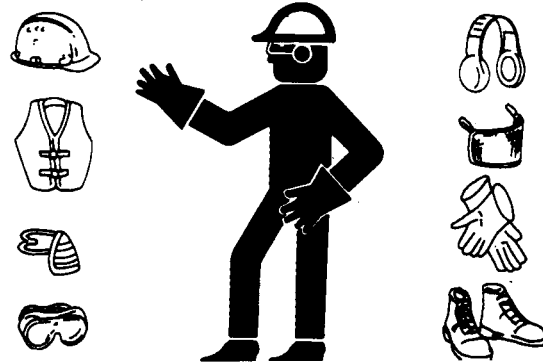

TS206 -UN-23AUG88

DX,WEAR2 -19-03MAR93-1/1

Safety

00
0001
8

Protect Against Flying Debris

Guard against injury from flying pieces of metal or debris; wear goggles or safety glasses.

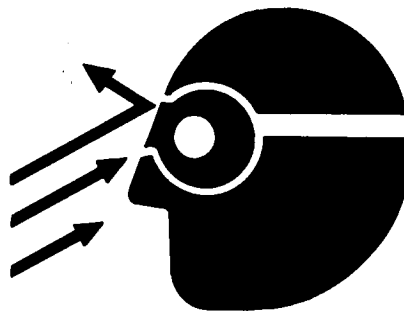

T6642DK -UN-18OCT88

TX,05,FF1613 -19-14JUN90-1/1

Protect Against Noise

Prolonged exposure to loud noise can cause impairment or loss of hearing.

Wear a suitable hearing protective device such as earmuffs or earplugs to protect against objectionable or uncomfortable loud noises.



TS207 -UN-23AUG88

DX,NOISE -19-03MAR93-1/1

Illuminate Work Area Safely

Illuminate your work area adequately but safely. Use a portable safety light for working inside or under the machine. Make sure the bulb is enclosed by a wire cage. The hot filament of an accidentally broken bulb can ignite spilled fuel or oil.

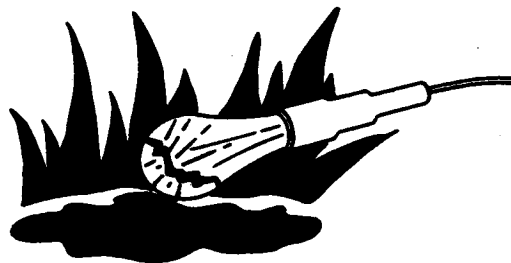

TS223 -UN-23AUG88

DX,LIGHT -19-04JUN90-1/1

Service Machines Safely

Tie long hair behind your head. Do not wear a necktie, scarf, loose clothing, or necklace when you work near machine tools or moving parts. If these items were to get caught, severe injury could result.

Remove rings and other jewelry to prevent electrical shorts and entanglement in moving parts.

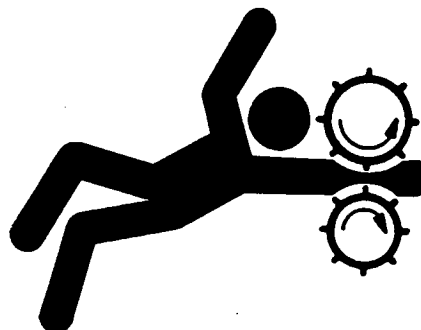

TS228 -UN-23AUG88

DX,LOOSE -19-04JUN90-1/1

Safety

Remove Paint Before Welding or Heating

Avoid potentially toxic fumes and dust.

Hazardous fumes can be generated when paint is heated by welding, soldering, or using a torch.

Do all work outside or in a well ventilated area. Dispose of paint and solvent properly.

Remove paint before welding or heating:

- If you sand or grind paint, avoid breathing the dust. Wear an approved respirator.
- If you use solvent or paint stripper, remove stripper with soap and water before welding. Remove solvent or paint stripper containers and other flammable material from area. Allow fumes to disperse at least 15 minutes before welding or heating.

00
0001
9

TS220 -UN-23AUG88

DX,PAINT -19-03MAR93-1/1

Avoid Heating Near Pressurized Fluid Lines

Flammable spray can be generated by heating near pressurized fluid lines, resulting in severe burns to yourself and bystanders. Do not heat by welding, soldering, or using a torch near pressurized fluid lines or other flammable materials. Pressurized lines can be accidentally cut when heat goes beyond the immediate flame area.



TS953 -UN-15MAY90

DX,TORCH -19-03MAR93-1/1

Beware of Exhaust Fumes

Prevent asphyxiation. Engine exhaust fumes can cause sickness or death.

If you must operate in a building, be positive there is adequate ventilation. Either use an exhaust pipe extension to remove the exhaust fumes or open doors and windows to bring enough outside air into the area.

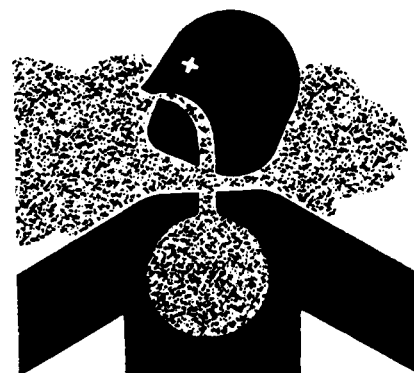

T6468AO -UN-18OCT88

02T,05,J9 -19-07JAN91-1/1

Safety

00
0001
10

Use Proper Lifting Equipment

Lifting heavy components incorrectly can cause severe injury or machine damage.

Follow recommended procedure for removal and installation of components in the manual.

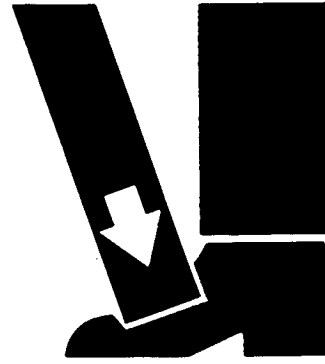

TS226 -UN-23AUG88

DX,LIFT -19-04JUN90-1/1

Service Cooling System Safely

Explosive release of fluids from pressurized cooling system can cause serious burns.

Shut off engine. Only remove filler cap when cool enough to touch with bare hands. Slowly loosen cap to first stop to relieve pressure before removing completely.



TS281 -UN-23AUG88

DX,RCAP -19-04JUN90-1/1

Dispose of Waste Properly

Improperly disposing of waste can threaten the environment and ecology. Potentially harmful waste used with John Deere equipment include such items as oil, fuel, coolant, brake fluid, filters, and batteries.

Use leakproof containers when draining fluids. Do not use food or beverage containers that may mislead someone into drinking from them.

Do not pour waste onto the ground, down a drain, or into any water source.

Air conditioning refrigerants escaping into the air can damage the Earth's atmosphere. Government regulations may require a certified air conditioning service center to recover and recycle used air conditioning refrigerants.

Inquire on the proper way to recycle or dispose of waste from your local environmental or recycling center, or from your John Deere dealer.

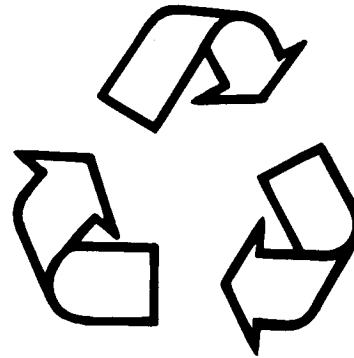

TS1133 -UN-26NOV90

DX,DRAIN -19-03MAR93-1/1