

EURO CARGO TECTOR

12 TO 26 t

REPAIR MANUAL

IVECO

"This document provides data, characteristics, instructions and methodology to perform repair interventions on the vehicle and its components.

Anyway, this document is addressed to qualified and specialised personnel. Iveco commercial and assistance network personnel as well as all Iveco authorised points of assistance are specifically qualified and equipped to perform the repair interventions that are indicated in this document.

Before performing any intervention, check to have available the document relating to the vehicle model on which the intervention is being performed and also make sure that all accident prevention devices, such as, as a rough guide, goggles, helmet, gloves, shoes, as well as work tooling, lifting and transport tooling, etc., are available and efficient, and further make sure that the vehicle is put such a way that an intervention can be made in safety conditions.

Making interventions strictly observing the indications given here, as well as using specific tooling indicated, assures a correct repair intervention, execution timing observance and operators' safety.

Each repair intervention must be finalised to the recovery of functionality, efficiency and safety conditions that are provided by Iveco.

Each intervention, on the vehicle, that is finalised to a modification, alteration or else, which is not authorised by Iveco, involves the exclusion of any responsibility for Iveco, and, in particular, where the vehicle is covered by a guarantee, each such intervention involves an immediate lapse of the guarantee.

Responsibility for Iveco in repair intervention execution is excluded.

Iveco is available to provide all clarifications necessary to make interventions, as well as to provide indications in cases and situations not included in this document.

Data and information contained in this document could result not to be updated owing to modifications made by Iveco at any moment for technical or commercial reasons, or because of the need to adapt the vehicle to law requirements in different countries.

In the case of a difference between what contained here and what actually found on the vehicle, please contact Iveco network before making any intervention."

The data contained in this publication might fail to reflect the latest changes which the Manufacturer may introduce at any time, for technical or sales purposes, or to meet the requirements of local legislation.

Copy, even partial, of text and drawings is forbidden.

Publication Edited by:
IVECO S.p.A.
Customer Service
Lungo Stura Lazio, 15
10156 Torino (TO) - Italy

Print **603.93.391** - 1st Ed. 2004

Produced by:

The logo for SATIZmsx INTERNATIONAL. It features the word "SATIZ" in a bold, black, sans-serif font, followed by "msx" in a red, lowercase, sans-serif font. Below "SATIZmsx" is the word "INTERNATIONAL" in a smaller, black, uppercase, sans-serif font. A red graphic element, resembling a stylized arrow or a drop, is positioned above the "msx" part of the logo.

B.U. TECHNICAL PUBLISHING
Iveco Technical Publications
Lungo Stura Lazio, 15
10156 Torino (TO) - Italy

PRELIMINARY REMARKS

Manuals for repairs are split into Sections, each one of which is marked by a numeral; the contents of these sections are indicated in the general table of contents.

Each section is generally dedicated to a main Unit (e.g.: engine, gearbox, electric system, etc.).

Sections with mechanical contents include technical data, tightening torque collections, tool lists, connections – disconnections of units to/from the vehicle, overhauls at the bench and relating troubleshooting.

On the electric/electronic system section there are the descriptions of the electric network and vehicle electronic systems, electric schemes, components electric characteristics, components codes and troubleshooting relating to the central units specific of the electric system.

The manual uses proper symbols in its descriptions; the purpose of these symbols is to classify contained information. In particular, there have been defined a set of symbols to classify warnings and a set for assistance operations.

SYMBOLS - WARNINGS



Danger for persons

Missing or incomplete observance of these prescriptions can cause serious danger for persons' safety.



Danger of serious damage for the vehicle

Partial or complete non observance of these prescriptions can cause serious damages to the vehicle and sometimes guarantee lapse too.



General danger

It includes the dangers of above described signals.



































Environment protection

It indicates correct behaviour in order that vehicle use is environmentally friendly as much as possible.

NOTE It indicates an additional explanation for a piece of information.

SYMBOLS - ASSISTANCE OPERATIONS

	Removal Disconnection
	Refitting Connection
	Removal Disassembly
	Fitting in place Assembly
	Tighten to torque
	Tighten to torque + angle value
	Press or caulk
	Regulation Adjustment
	Visual inspection Fitting position check
	Measurement Value to find Check
	Equipment
	Surface for machining Machine finish
	Interference Strained assembly
	Thickness Clearance
	Lubrication Damp Grease
	Sealant Adhesive
	Air bleeding
	Replacement Original spare parts

	Intake
	Exhaust
	Operation
ϱ	Compression ratio
	Tolerance Weight difference
	Rolling torque
	Rotation
	Angle Angular value
	Preload
	Number of revolutions
	Temperature
	Pressure
>	Oversized Higher than.... Maximum, peak
<	Undersized Less than.... Minimum
	Selection Classes Oversizing
	Temperature < 0 °C Cold Winter
	Temperature > 0 °C Hot Summer

PRODUCT CODE

Each title or subtitle concerning operations being performed is preceded by a six-figure number named PRODUCT CODE. This number represents the **PRODUCT CODE** referred to by the repair operation contained in both REPAIR TIMES and TROUBLE CODE document.

As a quick reference there are shown below the guide lines to read this code (see Repair Timing, too).

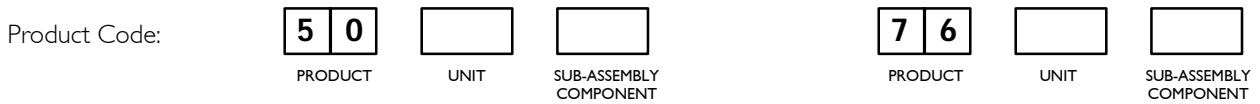

The first and second figures identify the PRODUCT within motor vehicle.

Example :

Product	50	=	Vehicle chassis;
Product	52	=	Axles;
Product	53	=	Transmission;
Product	76	=	Electric ssystem.

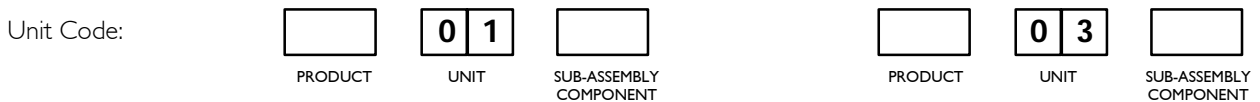

The third and fourth figures identify the UNIT within the PRODUCT.

Example :

Product	50	=	Vehicle chassis;
Unit	01	=	Chassis;
Unit	02	=	Bumpers;
Unit	03	=	Alternator.

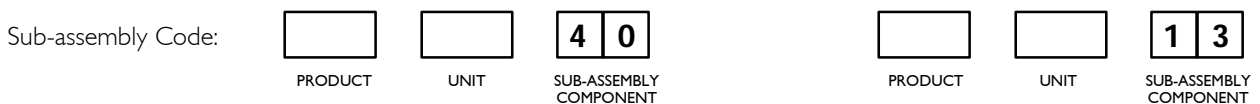

The fifth and sixth figures exactly identify the SUB-ASSEMBLY and Component of a Unit within a PRODUCT.

Example :

Product	50	=	Vehicle chassis;
Unit	01	=	Chassis;
Sub-assembly	40	=	Chassis cross members;
Sub-assembly	13	=	Rotor.

GENERAL WARNINGS



Warnings shown cannot be representative of all danger situations possibly occurring. Therefore, it is suggested to contact immediate superiors where a danger situation occurs which is not described.

Use both specific and general-purpose toolings according to the prescriptions contained in respective use and maintenance handbooks. Check use state and suitability of tools not subjected to regular check.

The manual handling of loads must be assessed in advance because it also depends, besides weight, on its size and on the path.

Handling by mechanical means must be with hoisters proper as for weight as well as for shape and volume. Hoisters, ropes and hooks used must contain clear indications on maximum carrying capacity acceptable. The use of said means is compulsorily permitted to authorised personnel only. Stay duly clear of the load, and, anyhow, never under it.

In disassembling operations, always observe provided prescriptions; prevent mechanical parts being taken out from accidentally striking workshop personnel.

Workshop jobs performed in pairs must always be performed in maximum safety; avoid operations which could be dangerous for the co-operator because of lack of visibility or of his/her not correct position.

Keep personnel not authorised to operations clear of working area.

Learn operation and safety knowledge necessary relating to the vehicle prior to each intervention on it. Scrupulously observe all safety warnings on the vehicle. Apply suitable signals for the vehicles being repaired. Once the repair intervention has been completed, before starting up the vehicle, perform all checks indicated on paragraph "Controls care of user" of Use and Maintenance handbook.

In lack of visibility in operating from the vehicle, charge a person on the ground with assistance. Do not leave unmanned a vehicle in motion during repair interventions.

Keep the vehicle stationary by proper chocks.

In the case of an intervention on a vehicle lifted from the ground, check the vehicle to be quite steady on special support stands and, in the case of lifting by means of a lift, check manual/automatic safeties to be activated.

When it is necessary to perform an intervention on methane-fed vehicles, observe the indications contained inside the document, as well as all specific safety regulations provided.

Only remove radiator cap when the engine is cold by cautiously unscrewing it in order to let system residual pressure out.

Inflammable fuel and all inflammable fluids and liquids must be handled with care, according to what contained on harmful materials 12-point cards. Refuelling must be performed outdoors with the engine off, avoiding lit cigarettes, free flames or sparks in order to prevent sudden fires/bursts. Adequately store inflammable, corrosive and polluting fluids and liquids according to what provided by regulations in force. Compulsorily avoid to use food containers to store harmful liquids. Avoid to drill or bore pressurised containers, and throw cloths impregnated with inflammable substances into suitable containers.

Worn out, damaged or consumable parts must be replaced by Iveco original spares.

During workshop activity, always keep the work place clean; timely clear or clean floors from accidental liquid or oil spots. Electric sockets and electric equipment necessary to perform repair interventions must meet safety rules.

For every intervention on vehicle hydraulic, pneumatic, conditioning and AIR - BAG systems, scrupulously observe indications specified in relating manual sections.

GENERAL WARNINGS



Put on, where required by the intervention, garments and protections provided in accident prevention rules; contact with moving parts can cause serious injuries. Use suitable, preferably tight-fitted garments, and avoid to use jewels, scarves, etc.

Do not leave the engine in motion at workshop locations not provided with a pipe to scavenge exhaust gas outside.

Avoid to breathe fumes coming from heating or from paint welding because they can cause damages to health; operate outdoors or in suitably ventilated areas. Put on proper inspirator if paint powder is present.

Avoid contact with hot water or steam coming from the engine, radiator and pipings because they could cause serious burns. Avoid direct contact with liquids and fluids present in vehicle systems; where an accidental contact has occurred, refer to 12-point cards for provisions to make.



Clean units or assemblies detached from the vehicle and carefully check their integrity before overhaul. Tidy up detached or disassembled parts with their securing elements (screws, nuts, etc.) into special containers.

Check for the integrity of the parts which prevent screws from being unscrewed: broken washers, dowels, clips, etc. Self-locking nuts with an insert made of nylon must always be replaced.

Avoid contact of rubber parts with diesel oil, petrol or other not compatible substances.

Before washing under pressure mechanical parts, protect electric connectors, and central units, if present.

Tightening screws and nuts must always be according to prescriptions; IVECO commercial and assistance network is available to give all clarifications necessary to perform repair interventions not provided in this document.

Before welding:

- Disconnect all electronic central units, take power cable off battery positive terminal (connect it to chassis bonding) and detach connectors.
- Remove paint by using proper solvents or paint removers and clean relevant surfaces with soap and water.
- Await about 15 minutes before welding.
- Equip with suitable fire resistant protections to protect hoses or other components where fluids or other materials flow which may catch fire easily on welding.

Should the vehicle be subjected to temperatures exceeding 80°C (dryer ovens), disassemble drive electronic central units.



The disposal of all liquids and fluids must be performed with full observance of specific rules in force.

GENERAL WARNINGS ON THE ELECTRIC SYSTEM



If an intervention has to be made on the electric/electronic system, disconnect batteries from the system; in this case, always disconnect, as a first one, the chassis bonding cable from batteries negative terminal.

Before connecting the batteries to the system, make sure that the system is well isolated.

Disconnect the external recharging apparatus from the public utility network before taking apparatus pins off battery terminals.

Do not cause sparks to be generated in checking if the circuit is energised.

Do not use a test lamp in checking circuit continuity, but only use proper control apparatuses.

Make sure that the electronic devices wiring harnesses (length, lead type, location, strapping, connection to screening braiding, bonding, etc.) comply with IVECO system and are carefully recovered after repair or maintenance interventions.

Measurements in drive electronic central units, plugged connections and electric connections to components can only be made on proper testing lines with special plugs and plug bushes. Never use improper means like wires, screwdrivers, clips and the like in order to avoid the danger of causing a short circuit, as well as of damaging plugged connections, which would later cause contact problems.



To start up the engine, do not use fast chargers. Start up must only be performed with either separate batteries or special truck.

A wrong polarisation of supply voltage in drive electronic central units (for instance, a wrong polarisation of batteries) can cause them to be destroyed.

Disconnect the batteries from the system during their recharging with an external apparatus.

On connecting, only screw up connector (temperature sensors, pressure sensors etc.) nuts at prescribed tightening torque.

Before disconnecting the junction connector from an electronic central unit, isolate the system.

Do not directly supply electronic central units servo components at nominal vehicle voltage.

Cables must be arranged such as to result to be parallel to reference plane, i.e. as close as possible to chassis/body structure.

Once the intervention on the electric system has been completed, recover connectors and wiring harnesses according to original arrangement.

Key memorisation procedures are influenced by electromagnetic jamming (mobile phones, etc.). Therefore, during key memorisation:

- 1 Pay attention that jamming sources are not present in the cab or near the keys.
- 2 Keys not inserted in the panel must be at least 1 meter away.

NOTE Connectors present must be seen from cable side. Connectors views contained in the manual are representative of cable side.

Bonding and screening

Negative leads connected to a system bonded point must be both as short and possible and "star"-connected to each other, trying then to have their centering tidily and properly made (Figure 1, re. M).

Further, following warnings are to be compulsorily observed for electronic components:

- Electronic central units must be connected to system bonding when they are provided with a metallic shell.
- Electronic central units negative cables must be connected both to a system bonding point such as the dashboard opening bonding (avoiding "serial" or "chain" connections), and to battery negative terminal.
- Analog bonding (sensors), although not connected to battery negative system/terminal bonding, must have optimal isolation. Consequently, particularly considered must be parasitic resistances in lugs: oxidising, clinching defects, etc.
- Screened circuits braiding must only electrically contact the end towards the central unit entered by the signal (Figure 2).
- If junction connectors are present, unscreened section **d**, near them, must be as short as possible (Figure 2).
- Cables must be arranged such as to result to be parallel to reference plane, i.e. as close as possible to chassis/body structure.

Figure 1

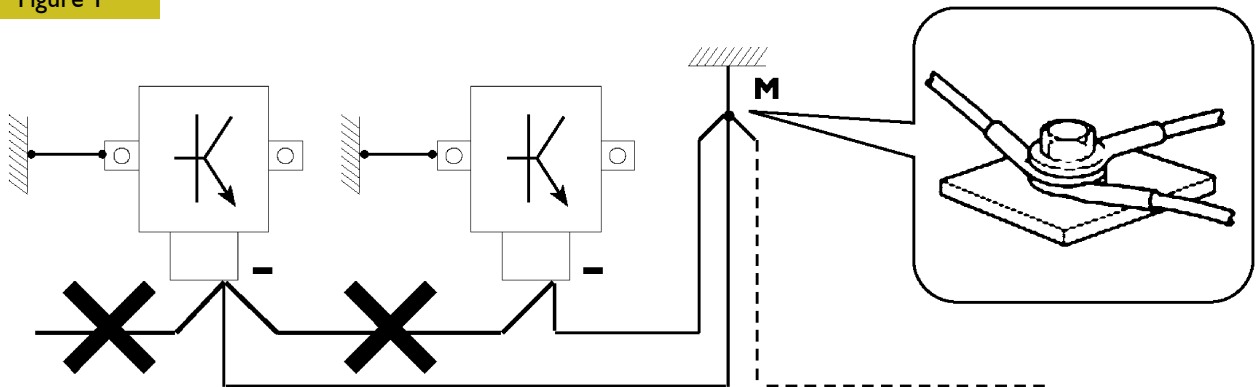

1. NEGATIVE CABLES "STAR" CONNECTION TO SYSTEM BONDING M

Figure 2

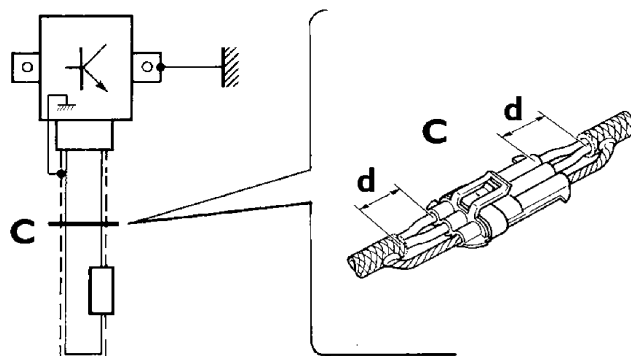

2. SCREENING THROUGH METALLIC BRAIDING OF A CABLE TO AN ELECTRONIC COMPONENT – C. CONNECTOR
d. DISTANCE → 0

88039

OPTIONAL ELECTRICAL AND MECHANICAL PARTS INSTALLATIONS

Accessories mounting, additions and modifications on the vehicle are to be performed complying with IVECO mounting instructions (specific document "Instructions for transformation and preparation" is available at Assistance Network workshops). It is reminded that, especially about the electric system, several electric sockets are provided for as series (or optional) sockets in order to simplify and normalise the electrical intervention that is care of preparation personnel.

For any exception to mounting instructions, IVECO's authorisation is necessary.

Lack of observance of above described prescriptions involves guarantee lapse.



It is absolutely forbidden to make modifications or connections to electric central units wiring harnesses; in particular, the data interconnection line between central units (CAN line) is to be considered inviolable.

CONVERSIONS BETWEEN THE MAIN UNITS OF MEASUREMENT OF THE INTERNATIONAL SYSTEM AND MOST USED DERIVED QUANTITIES

Power

1 kW	=	1.36 metric HP
1 kW	=	1.34 HP
1 metric HP	=	0.736 kW
1 metric HP	=	0.986 HP
1 HP	=	0.746 kW
1 Hp	=	1.014 metric HP

Torque

1 Nm	=	0.1019 kgm
1 kgm	=	9.81 Nm

Revolutions per time unit

1 rad/s	=	1 rpm × 0.1046
1 rpm	=	1 rad/s × 9.5602

Pressure

1 bar	=	1.02 kg/cm ²
1 kg/cm ²	=	0.981 bar
1 bar	=	10 ⁵ Pa

(Nm and bar units are converted according to 10:1 and 1:1 for the sake of simplicity)

1 kgm	=	10 Nm
1 kg/cm ²	=	1 bar

Temperature

0° C	=	32° F
1° C	=	(1 × 1.8 + 32) ° F

EUROCARGO TECTOR 12-26t

Print 603.93.391 – 1st edition
Base – October 2004

UPDATE DATA

Section	Description	Page	Revision date





INDEX OF SECTIONS

	Section
General Specifications	I
Engine	2
Clutch	3
Gearbox	4
Propeller shafts	5
Rear axles	6
Front Axles	7
Suspensions	8
Wheels and tyres	9
Steering	10
Pneumatic system – brakes	11
Body and chassis	12
Service plan	13
Electric/electronic system	14

SECTION I**General Specifications**

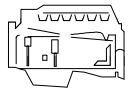
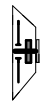

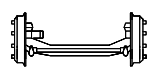
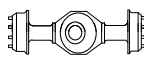
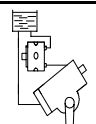

	Page
COMPOSITION OF THE MODELS	3
IDENTIFICATION DATA AND LOCATION ON VEHICLE	13
FILLING UP	14
INTERNATIONAL LUBRICANT DESIGNATION	15

**GENERAL SPECIFICATIONS
COMPOSITION OF THE MODELS**

UNITS		MODELS 4 x 2																	
		MLI10EL17	MLI10EL17P	MLI10EL17R	MLI10EL17R/P	MLI10EL21	MLI10EL21/P	MLI10EL21R	MLI10EL21R/P	MLI20EL17	MLI20EL17P	MLI20EL17R	MLI20EL17R/P	MLI20EL21	MLI20EL21/P	MLI20EL21R	MLI20EL21R/P	MLI20E18	MLI20E18/P
	F4AE0481A (170 HP)	•	•	•	•					•	•	•	•						
	F4AE0681E (180 HP)																	•	•
	F4AE0681D (210 HP)					•	•	•	•					•	•	•	•		
	F4AE0681B (240 HP)																		
	F4AE0681A (275 HP)																		
	Single plate																		
	13"	•	•	•	•					•	•	•	•						
	14"					•	•	•	•					•	•	•	•	•	•
	13"/14"																	•	•
	2855S.6	•	•							•	•							•	•
	2865S.6					•	•						•	•					
	2870S.9	•	•	•	•	•	•	•	•	•	•	•	•	•	•	•	•	•	•
	2895S.9																		
	FSO 5206B																		
	MD 3060P																		
	5845	•	•	•	•	•	•	•	•	•	•	•	•	•	•	•	•	•	•
	5842/5																	•	•
	5851/5																		
	5860																		
	5871/5																		
	MS08-125	•	•	•	•	•	•	•	•	•	•	•	•	•	•	•	•	•	•
	MS10-144																	•	•
	MS10-164																		
	MS13-165																		
	SPI45E																		
	ZF 8095																	•	•
	ZF 8098																		
	TRW-TAS 55	•	•	•	•	•	•	•	•	•	•	•	•	•	•	•	•	•	•
	Mechanical front	•	•	•	•	•	•	•	•	•	•	•	•	•	•	•	•	•	•
	Mechanical rear	•		•		•		•		•		•		•		•		•	
	Pneumatic front																		
	Pneumatic rear		•		•		•		•		•		•		•		•		•
	Disk front	•	•	•	•	•	•	•	•	•	•	•	•	•	•	•	•	•	•
	Disk rear	•	•	•	•	•	•	•	•	•	•	•	•	•	•	•	•	•	•
	Drum rear																		

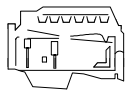

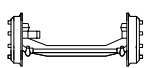
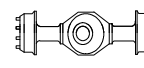
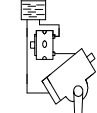



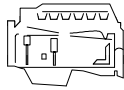

K = Dump body; R = Trailing vehicle; T = Tractor; P = Vehicles with pneumatic suspension on rear axle; FP = Vehicles with front and rear pneumatic suspension; D = Double cabin (6 + 1); RS = Road Sweeper

COMPOSITION OF THE MODELS

UNITS	MODELS 4 x 2	MLI 20E18/FP	MLI 20E18R	MLI 20E18R/P	MLI 20E18R/FP	MLI 20E18K	MLI 20E18KR	MLI 20E18D	MLI 20E18D/P	MLI 20E18DR	MLI 20E18DR/P	MLI 20E18DK	MLI 20E18DKR	MLI 20E21	MLI 20E21/P	MLI 20E21/FP	MLI 20E21R	MLI 20E21R/P	MLI 20E21R/FP	
			F4AE0481A (170 HP)																	
	F4AE0681E (180 HP)	•	•	•	•	•	•	•	•	•	•	•	•							
	F4AE0681D (210 HP)													•	•	•	•	•	•	•
	F4AE0681B (240 HP)																			
	F4AE0681A (275 HP)																			
	13"																			
Single plate	14"	•	•	•	•	•	•	•	•	•	•	•	•	•	•	•	•	•	•	•
	13"/14"	•	•	•	•	•	•	•	•	•	•	•	•							
	15"/16"																			
	2855S.6	•				•		•	•			•								
	2865S.6													•	•	•				
	2870S.9	•	•	•	•	•	•	•	•	•	•	•	•	•	•	•	•	•	•	•
	2895S.9																			
	FSO 5206B																			
	MD 3060P																			
	5845																			
	5842/5	•	•	•	•	•	•	•	•	•	•	•	•	•	•	•	•	•	•	•
	5851/5																			
	5860																			
	5871/5																			
	MS08-125																			
	MS10-144	•	•	•	•	•	•	•	•	•	•	•	•	•	•	•	•	•	•	•
	MS10-164																			
	MS13-165																			
	SPI45E																			
	ZF 8095	•	•	•	•	•	•	•	•	•	•	•	•	•	•	•	•	•	•	•
	ZF 8098																			
	TRW-TAS 55																			
	Mechanical front		•	•		•	•	•	•	•	•	•	•	•	•			•	•	
	Mechanical Rear		•			•	•	•	•			•	•	•				•		
	Pneumatic front	•							•			•				•				•
	Pneumatic rear	•		•	•				•		•				•	•			•	•
	Disk front	•	•	•	•	•	•	•	•	•	•	•	•	•	•	•	•	•	•	•
	Disk rear	•	•	•	•	•	•	•	•	•	•	•	•	•	•	•	•	•	•	•
	Drum rear																			

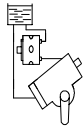



K = Dump body; R = Trailing vehicle; T = Tractor; P = Vehicles with pneumatic suspension on rear axle; FP = Vehicles with front and rear pneumatic suspension; D = Double cabin (6 + 1); RS = Road Sweeper

COMPOSITION OF THE MODELS

UNITS		MODELS 4 x 2		MLI 20E21K	MLI 20E21KR	MLI 20E24	MLI 20E24P	MLI 20E24FP	MLI 20E24R	MLI 20E24RP	MLI 20E24R/FP	MLI 20E24K	MLI 20E24KR	MLI 20E24D	MLI 20E24D/P	MLI 20E24DR	MLI 20E24DR/P	MLI 20E24DK	MLI 20E24DKR	MLI 20E28	MLI 20E28/P		
				F4AE0481A	(170 HP)																		
F4AE0681E	(180 HP)																						
F4AE0681D	(210 HP)			•	•																		
F4AE0681B	(240 HP)					•	•	•	•	•	•	•	•	•	•	•	•	•	•	•	•		
F4AE0681A	(275 HP)																					•	•
		13"																					
		14"	•	•	•	•	•					•		•	•				•				
		13"/14"																					
		15"/16"			•	•	•	•	•	•	•	•	•	•	•	•	•	•	•	•	•	•	•
		2855S.6																					
		2865S.6		•																			
		2870S.9		•	•																		
		2895S.9				•	•	•	•	•	•	•	•	•	•	•	•	•	•	•	•	•	•
		FSO 5206B				•	•	•					•		•	•				•			
		MD 3060P																					
		5845																					
		5842/5		•	•	•	•	•	•	•	•	•	•	•	•	•	•	•	•	•	•	•	
		5851/5																					
		5860																					
		5871/5																					
		MS08-125																					
		MS10-144		•	•	•	•	•	•	•	•	•	•	•	•	•	•	•	•	•	•	•	
		MS10-164																					
		MS13-165																					
		SPI45E																					
		ZF 8095		•	•	•	•	•	•	•	•	•	•	•	•	•	•	•	•	•	•	•	
		ZF 8098																					
		TRW-TAS 55																					
		Mechanical front		•	•	•	•			•	•		•	•	•	•	•	•	•	•	•	•	
		Mechanical Rear		•	•	•				•			•	•	•			•		•	•	•	
		Pneumatic front																					
		Pneumatic rear					•	•			•	•				•		•				•	
		Disk front		•	•	•	•	•	•	•	•	•	•	•	•	•	•	•	•	•	•	•	
		Disk rear		•	•	•	•	•	•	•	•	•	•	•	•	•	•	•	•	•	•	•	•
		Drum rear																					

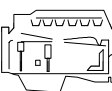
K = Dump body; R = Trailing vehicle; T = Tractor; P = Vehicles with pneumatic suspension on rear axle; FP = Vehicles with front and rear pneumatic suspension; D = Double cabin (6 + 1); RS = Road Sweeper

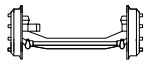
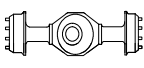
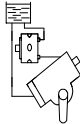
COMPOSITION OF THE MODELS

UNITS		MODELS 4 x 2		ML120E28/FP	ML120E28R	ML120E28R/P	ML120E28R/FP	ML120E28K	ML120E28KR	ML130E18	ML130E18/P	ML130E18/FP	ML130E18R	ML130E18R/P	ML130E18R/FP	ML130E18K	ML130E18KR	ML130E18RS*	ML130E18D	ML130E18D/P	ML130E18DR	ML130E18DR/P	
	F4AE0481A	(170 HP)																					
	F4AE0681E	(180 HP)								•	•	•	•	•	•	•	•	•	•	•	•	•	•
	F4AE0681D	(210 HP)																					
	F4AE0681B	(240 HP)																					
	F4AE0681A	(275 HP)		•	•	•	•	•	•	•													
	Single plate	13"																					
		14"								•	•	•	•	•	•	•	•	•	•	•	•	•	•
		13"/14"								•	•	•	•	•	•	•	•	•	•	•	•	•	•
		15"/16"		•	•	•	•	•	•	•													
	2855S.6									•	•	•								•	•		
	2865S.6																		•				
	2870S.9									•	•	•	•	•	•	•	•	•		•	•	•	•
	2895S.9		•	•	•	•	•	•	•														
	FSO 5206B																						
	MD 3060P																						
	5845																						
	5842/5		•	•	•	•	•	•	•	•	•	•	•	•	•	•	•	•	•	•	•	•	•
	5851/5																						
	5860																						
	5871/5																						
	MS08-125																						
	MS10-144		•	•	•	•	•	•	•	•	•	•	•	•	•	•	•	•	•	•	•	•	•
	MS10-164																						
	MS13-165																						
	SPI45E																						
	ZF 8095		•	•	•	•	•	•	•	•	•	•	•	•	•	•	•	•	•	•	•	•	•
	ZF 8098																						
	TRW-TAS 55																						
	Mechanical front		•	•		•	•	•	•	•	•	•	•	•	•	•	•	•	•	•	•	•	•
	Mechanical Rear		•			•	•	•		•						•	•	•	•		•		
	Pneumatic front		•		•										•								
	Pneumatic rear		•							•	•				•						•		•
	Disk front		•	•	•	•	•	•	•	•	•	•	•	•	•	•	•	•	•	•	•	•	•
	Disk rear		•	•	•	•	•	•	•	•	•	•	•	•	•	•	•	•	•	•	•	•	•
	Drum rear																						

K = Dump body; R = Trailing vehicle; T = Tractor; P = Vehicles with pneumatic suspension on rear axle; FP = Vehicles with front and rear pneumatic suspension; D = Double cabin (6 + 1); RS = Road Sweeper