

**ISUZU**  
TRUCK

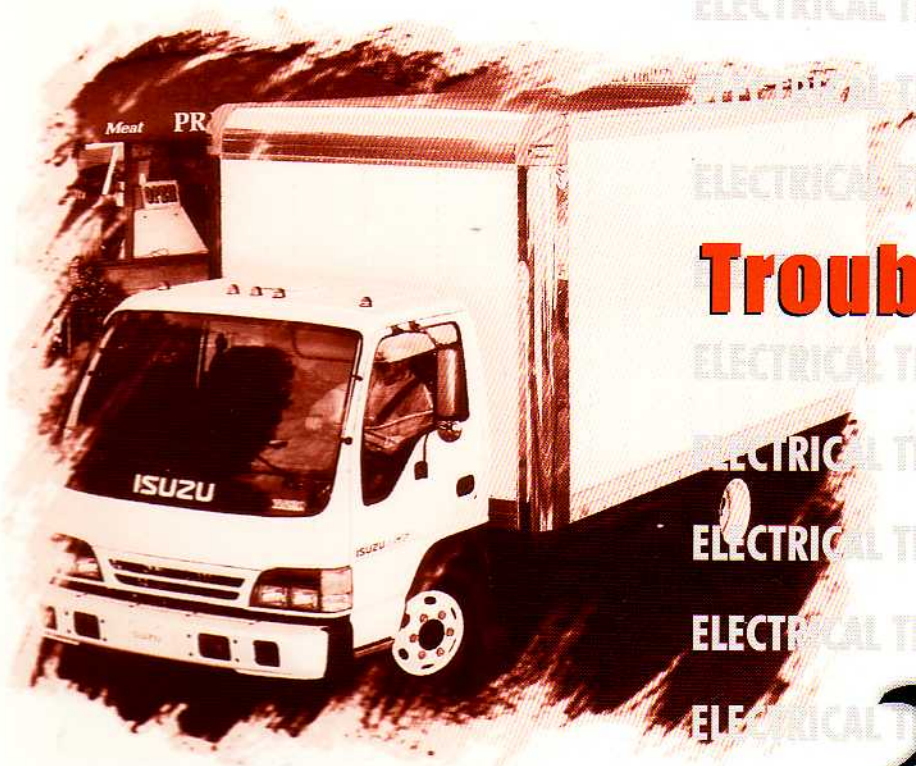

# Electrical Troubleshooting Manual

## 2000 NPR/NQR

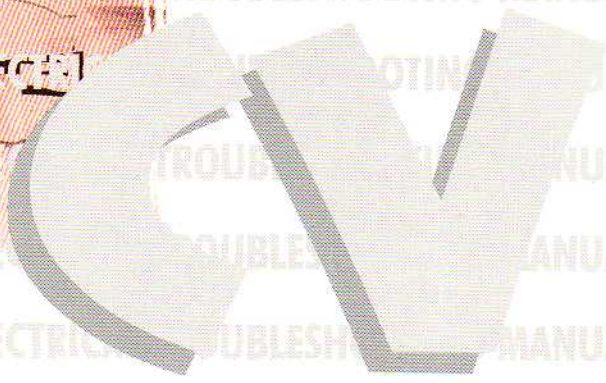

# 2000 NPR / NQR Electrical Troubleshooting Manual

## Contents

How to Use This Manual .....	2
Troubleshooting .....	2-10
Fuse/Relay Information .....	6
Circuit Schematics (see Circuit Index)	
Component Location Photographs .....	201
Harness Connector Views .....	202
Connector and Wire Harness Routing .....	203

Circuit Index	Diesel	Gas
Air conditioner		
Blower controls .....	60	60-1
Compressor controls .....	63	63-2
Anti-lock brake system (ABS) .....	44	44-4
A/T shift indicator .....	89	89-1
Automatic transmission controls ...	39	39-4
Back up lights .....	112	112-1
Blower controls .....	60	60-1
Brake lights .....	110-12	110-13
Brake warning system .....	71	71-2
Ceramic heater .....	61	
Charging system .....	22	22-2
Cigarette lighter .....	155	155
Compressor controls .....	63	63-2
Console lights .....	117	117-2
Cornering lights .....	110-16	110-18
Dash lights .....	117	117-2
Dome light .....	114	114
Engine controls .....	23	24
Engine coolant temperature gauge ..	81	81-2
Engine stop system .....	26	
Exhaust brake system .....	25	
Front park lights .....	110	110-2
Fuel gauge .....	81	81-2
Fuse box details .....	11	11-4
Gauges .....	81	81-2
Ground distribution .....	14	14-4
Hazard lights .....	110-6	110-8
Headlights .....	100	100-2
Heater .....	60	60-1
Horns .....	40	40
Ignition system .....		20
Indicators .....	80	80-3
License light .....	110-1	
Lighting switch details .....	12	12-3
Power distribution .....	10	10-4
Sound system .....	150	150
Speedometer .....	33	33-1
Starting system .....	21	21-2
Taillights .....	110-1	110-3
Turn lights .....	110-6	110-8
Vehicle speed sensor (VSS) .....	33	33-1
Windshield wiper/washer .....	91	91

All information contained in this manual is based on the latest product information available at the time of printing. We reserve the right to make changes at any time without notice. No part of this publication may be reproduced, stored in a retrieval system, or transmitted, in any form by any means, electronic, mechanical, photocopying, recording, or otherwise, without prior written permission of the publisher. This includes text, figures and tables.

# HOW TO USE THIS MANUAL

---

## Troubleshooting Information

This manual contains the following troubleshooting information:

- Fuse Information
- Circuit Details
  - Electrical Circuit Schematic
  - Component Location Index
  - Circuit Operation
  - Quick Checks (if required)
  - Troubleshooting (if required)
- Component Location Photographs
- Harness Connector Faces
- Harness Routing Views

The **Electrical Circuit Schematic** should always be your starting point in using this Electrical Troubleshooting Manual. The schematic shows the electrical current paths when a circuit is operating properly. It is essential to understand how a circuit *should* work before trying to figure out why it doesn't. Schematics are shown with the starter switch in the OFF position and other switches in the off or "at rest" position.

The **Component Location Index** helps you find where the parts of a circuit are located in a vehicle. A brief statement of the location is given and also a reference to a photograph that shows the component. These Component Location Photographs are in section 201. The index also lists the number of cavities within each connector and the connector color. Not all cavities will have wires.

The **Circuit Operation** will help you to understand the circuit. It describes the components and how the circuit works.

## Page Numbering

This manual is organized into sections with most sections containing circuit details. Each section has a unique number that will normally remain the same, year after year. For example, the headlights circuit will be section 100 with the first page of the section numbered 100. The following pages of this section will be numbered 100-1, 100-2, and 100-3.

# Symbols

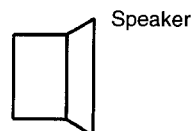
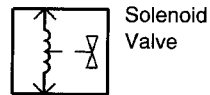
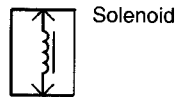
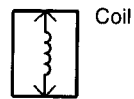
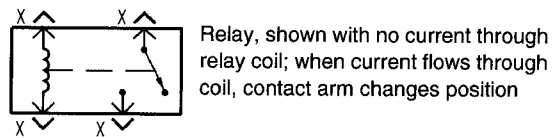
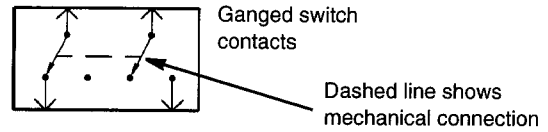
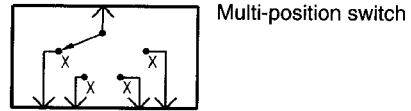
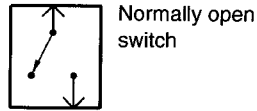
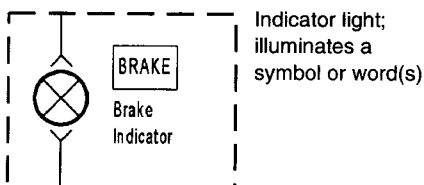
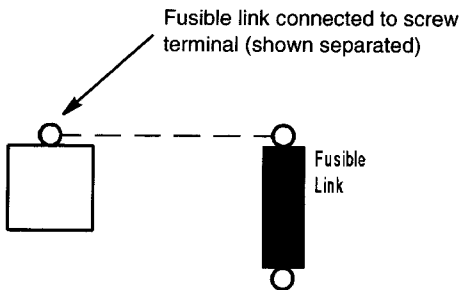
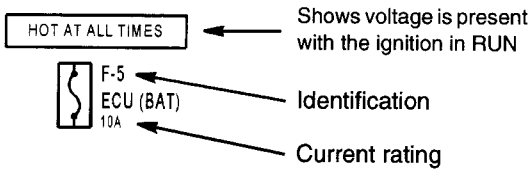
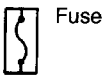
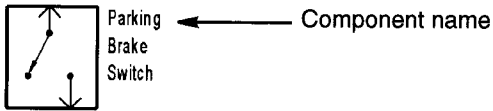
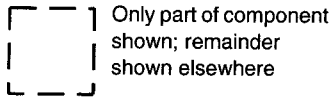
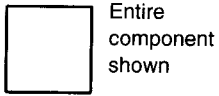

(cont'd)

# HOW TO USE THIS MANUAL

## Symbols (cont'd)

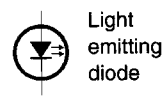
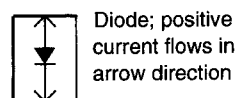
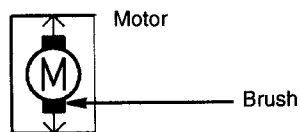
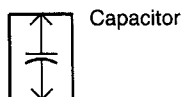
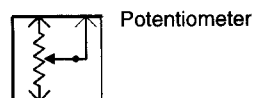
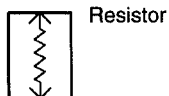

BLK.	black	Wire and connector colors
BLU.	blue	
BRN	brown	
CLR	clear	
GRN	green	
GRY	gray	
LT BLU	light blue	
LT GRN.	light green	
ORN	orange	
PNK	pink	
RED	red	
VIO	violet	
WHT	white	
YEL.	yellow	

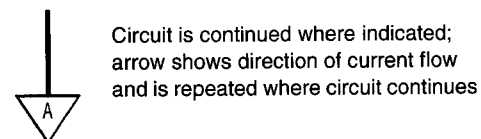
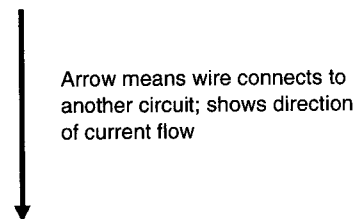
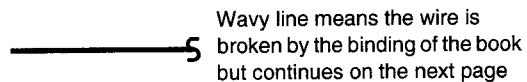

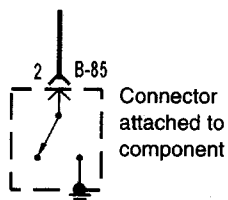
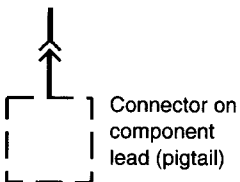
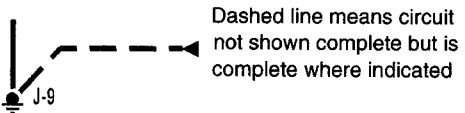
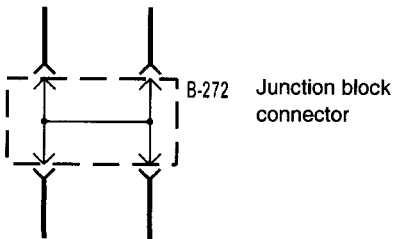
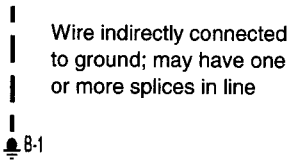
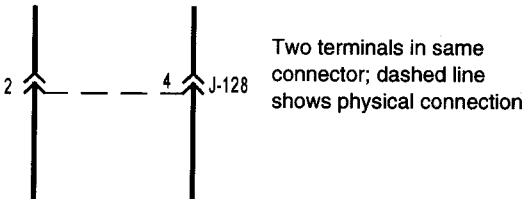
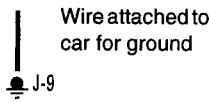
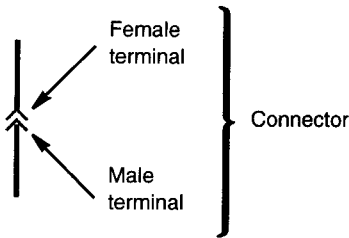
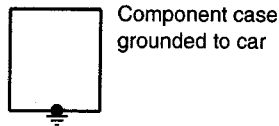
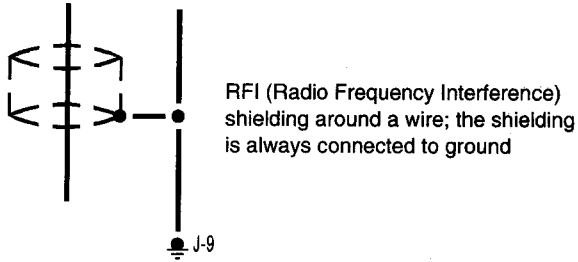
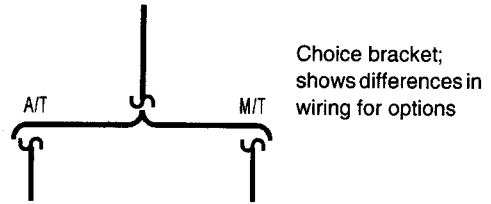
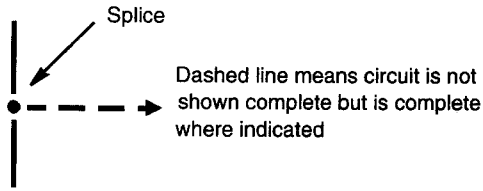

# HOW TO USE THIS MANUAL

## Circuit Schematics

Circuit schematics break the entire electrical system into individual circuits. **Electrical components that work together are shown together.**

**Each drawing is arranged so that current flows from positive at the top of the page, to ground, at the bottom of the page.** The "hot" labels at the top of a fuse show when the starter switch supplies power to that fuse.

Wires that connect to another circuit are shown with an arrowhead pointing in the direction of current flow. The name of the circuit that shares wiring is provided for reference.

"See Fuse Box Details" means that there are other connections to circuits that are not shown. These shared circuits are shown on the Fuse Box Details circuit schematic. "See Ground Distribution" means that there are shared ground circuits which are shown on the Ground Distribution circuit schematic.

No attempt is made on the schematic to represent components and wiring as they physically appear on the car. For example, a 4-foot length of wire is not treated any differently in a schematic than one which is only a few inches long. The number of cavities for each connector is listed in the Component Location Index rather than being illustrated. Similarly, switches and other components are shown as simply as possible with regard to function only.

The example on this page shows a horns schematic. Locate the horn schematic by using the Circuit Index. The circuit schematic will look similar to the one shown below. The schematic is read from top to bottom.

Voltage is applied to the horn relay at all times. When the relay coil is grounded by closing the horn switch, the relay contacts close. When the relay contacts are closed, both the LH and RH horns are energized.

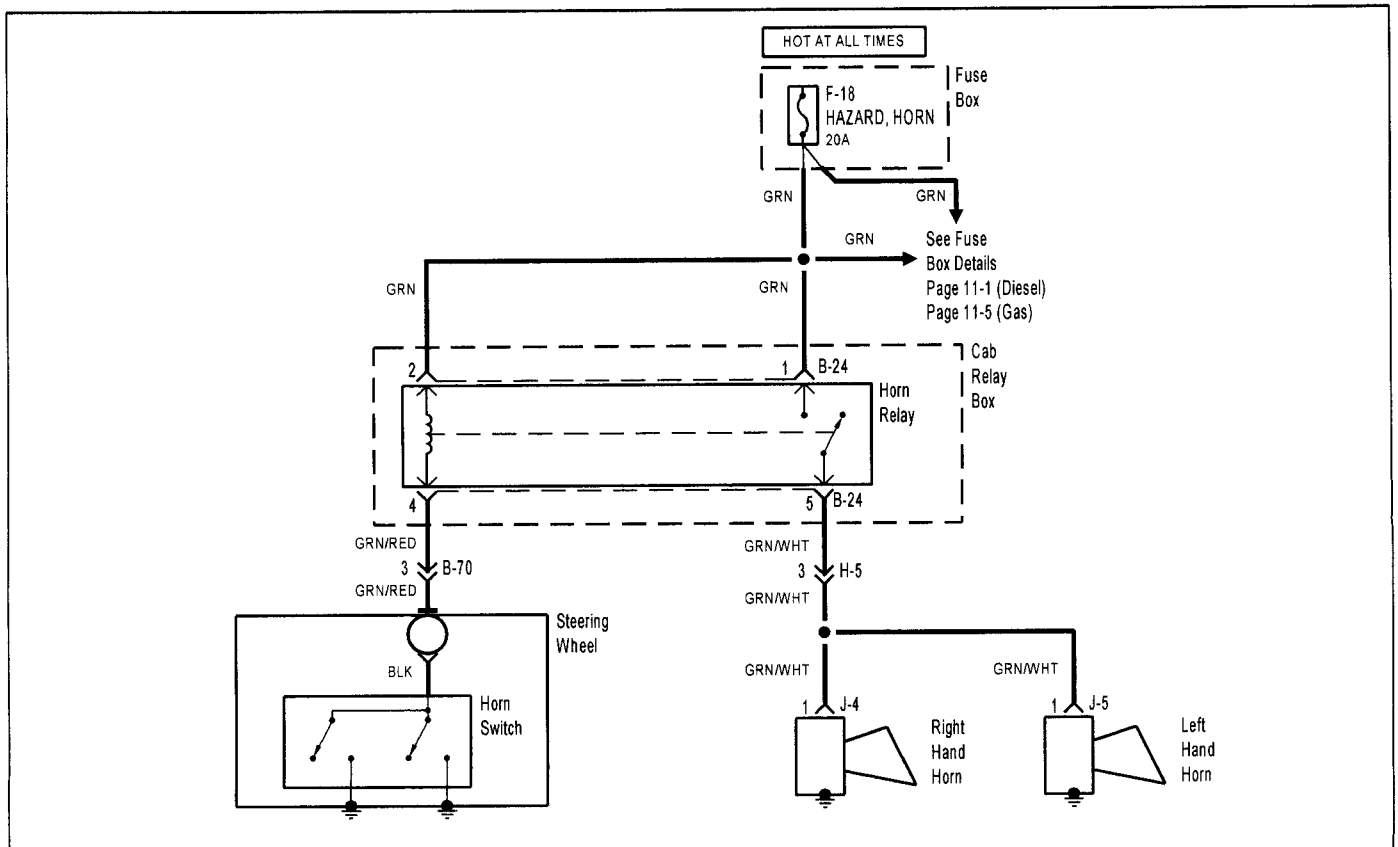

## Power Distribution

The Power Distribution schematic shows the wiring from the battery and generator to the starter solenoid, relay box, fuse box, starter switch and light switch. The first component after a fusible link is also shown. In certain instances, the first component after a fuse box fuse and light switch is also shown.

The Power Distribution schematic refers to Fuse Box Details and Lighting Switch Details schematics. By using these three (3) schematics, power distribution wiring can be followed from the battery and generator to the first component after a fusible link, fuse, and light switch. The ability to follow the power distribution wiring to the first component in each circuit is extremely helpful in locating short circuits which cause fusible links and fuses to open.

The fuses in the schematic below are "Hot At All Times," since battery voltage is always applied to them.

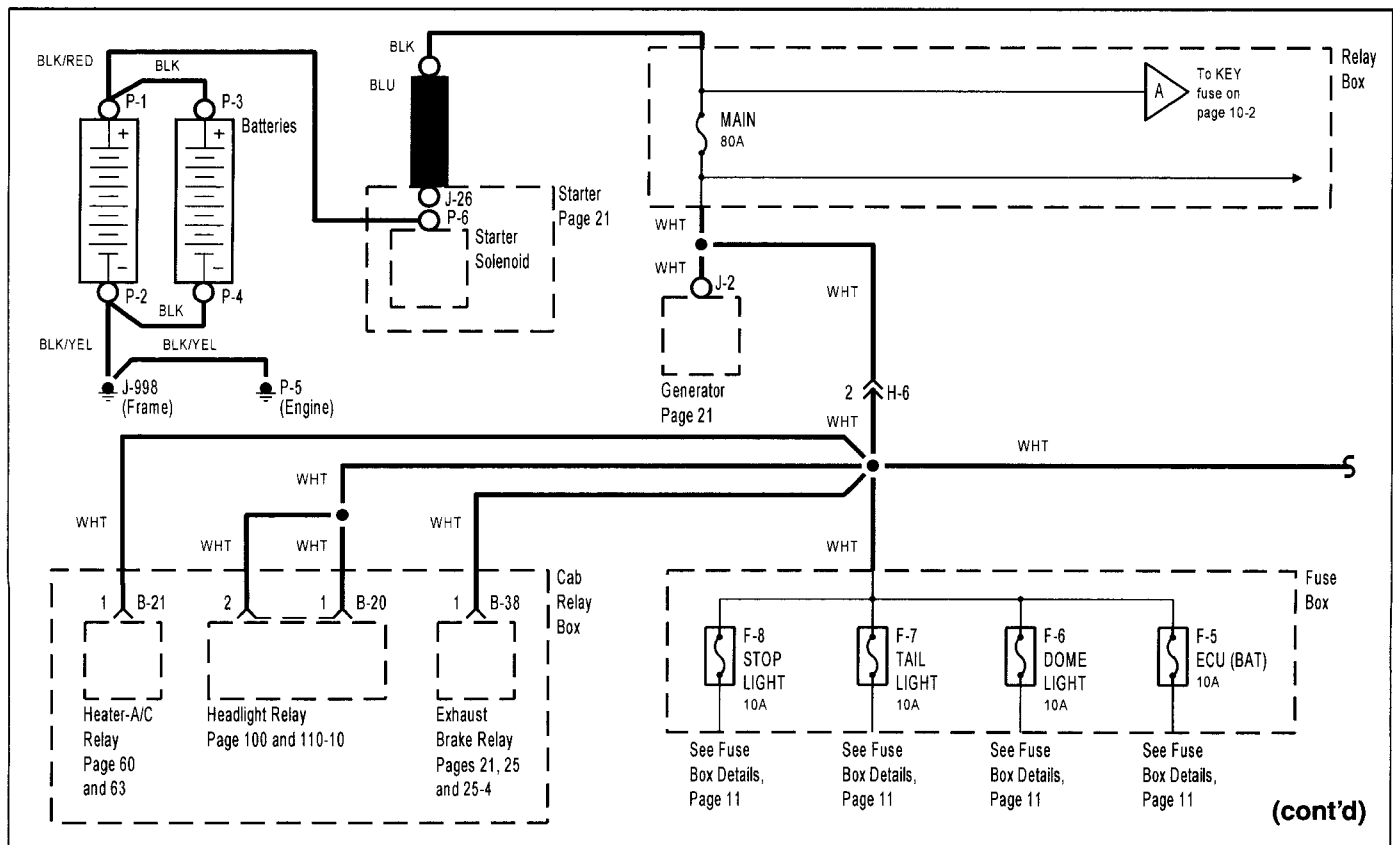



# HOW TO USE THIS MANUAL

## Circuit Schematics (cont'd)

### Fuse Box Details

The Fuse Box Details schematic shows all of the wiring between a fuse and the components connected to that fuse. The Fuse Box Details schematic is helpful in locating a short circuit that causes a fuse to open. This schematic may aid in troubleshooting an inoperative circuit by showing a second circuit that uses the same fuse. If the second circuit works, then the fuse and certain wires of the inoperative circuit are good.

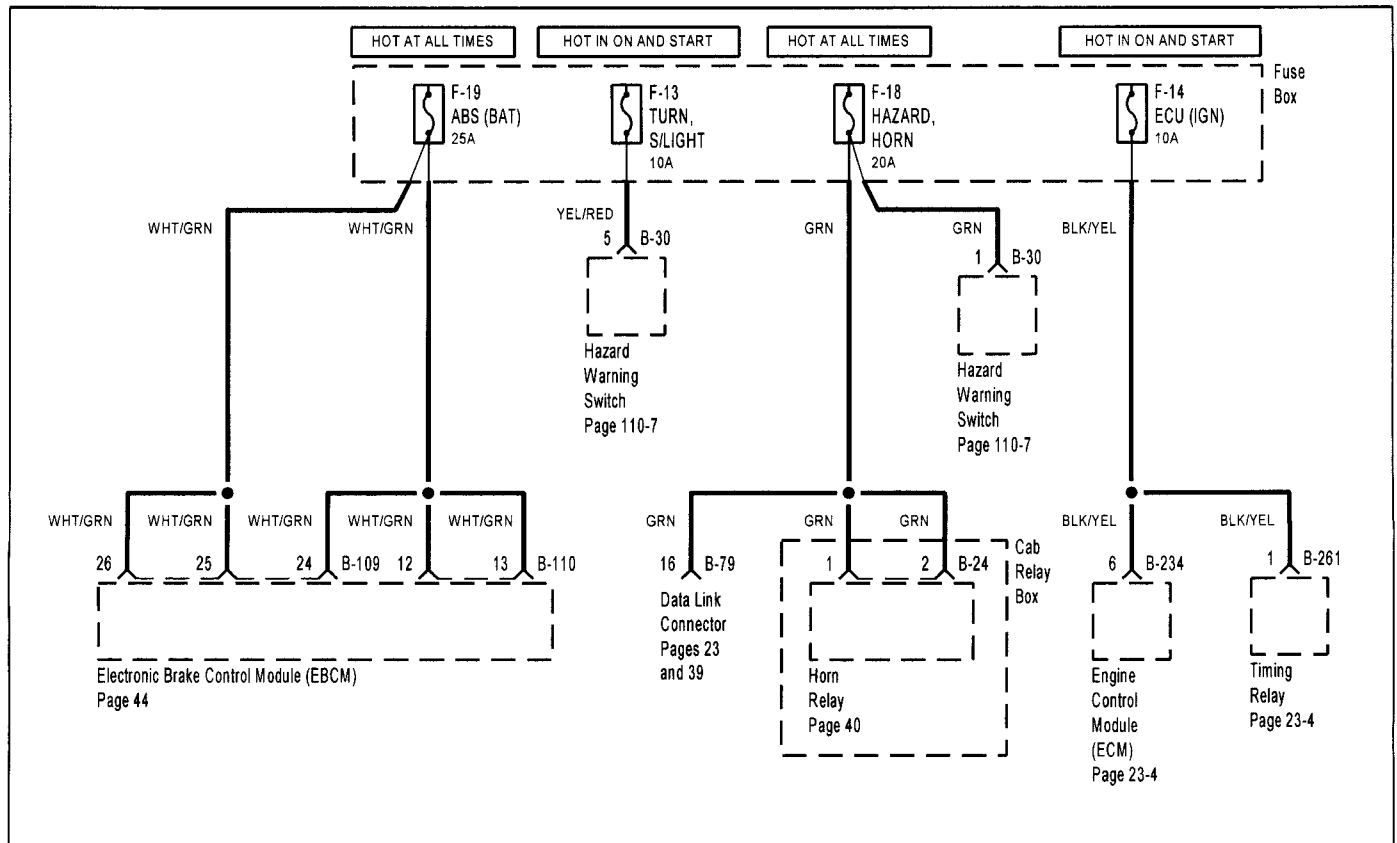

## Lighting Switch Details

The Lighting Switch Details schematic shows all the wiring between the light switch, light relays, and the components connected to the output of the light switch and relays. The Lighting Switch Details schematic is helpful in locating a short circuit on the output side of the light switch and relays.

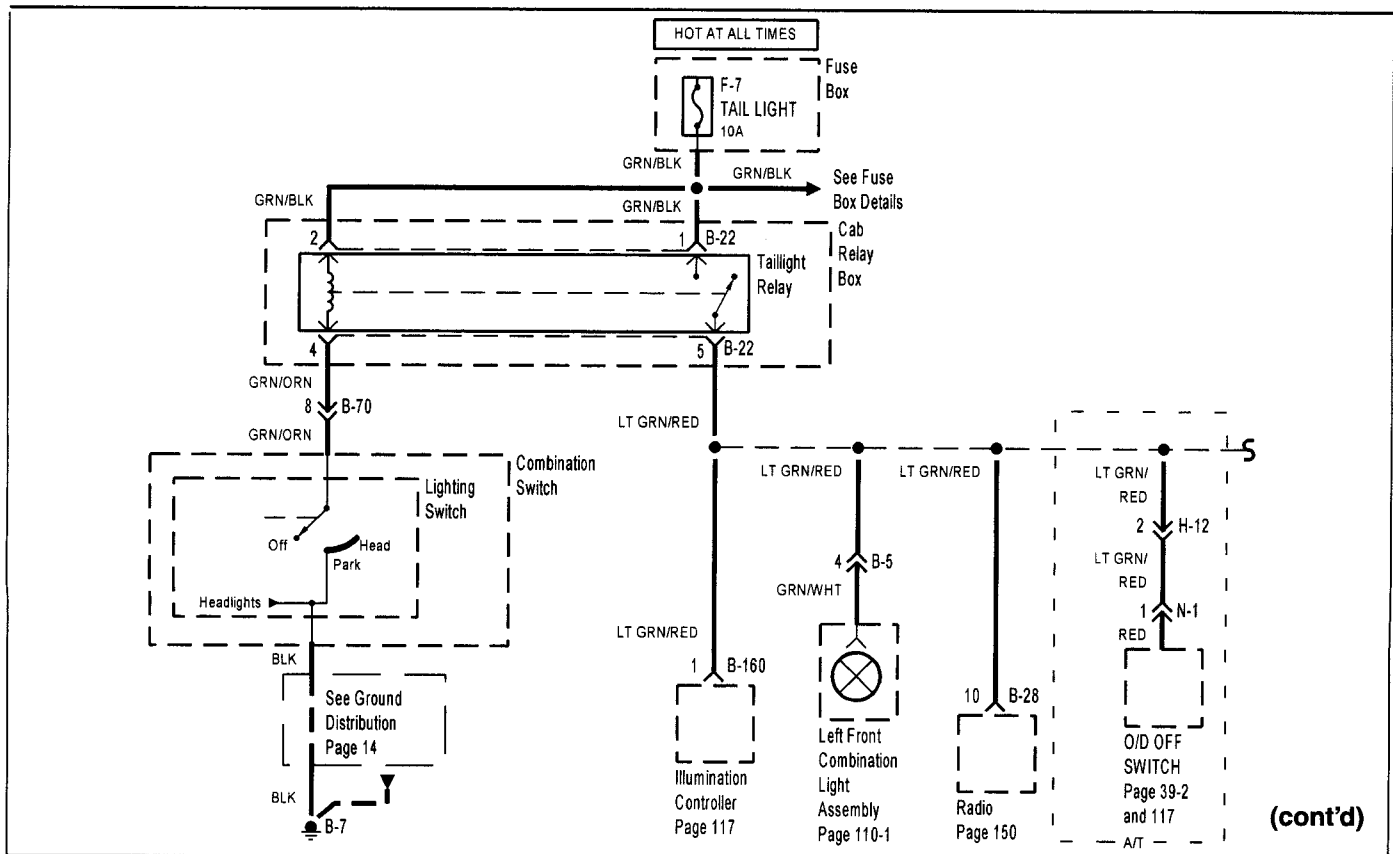

(cont'd)

# HOW TO USE THIS MANUAL

## Circuit Schematics (cont'd)

### Ground Distribution

The Ground Distribution schematics show which components share a ground point. This information can often be a time-saver when troubleshooting ground circuits. For example, in the schematic below, if both headlights and the park/turn light on one side are all out, you could suspect an open in their common ground wire or the ground connection itself. On the other hand, if one of the lights works, you know that the ground and the wire up to the splice are good. You have learned this just by inspecting the schematic and knowing the vehicle's symptoms. No actual work on the lighting system is needed.

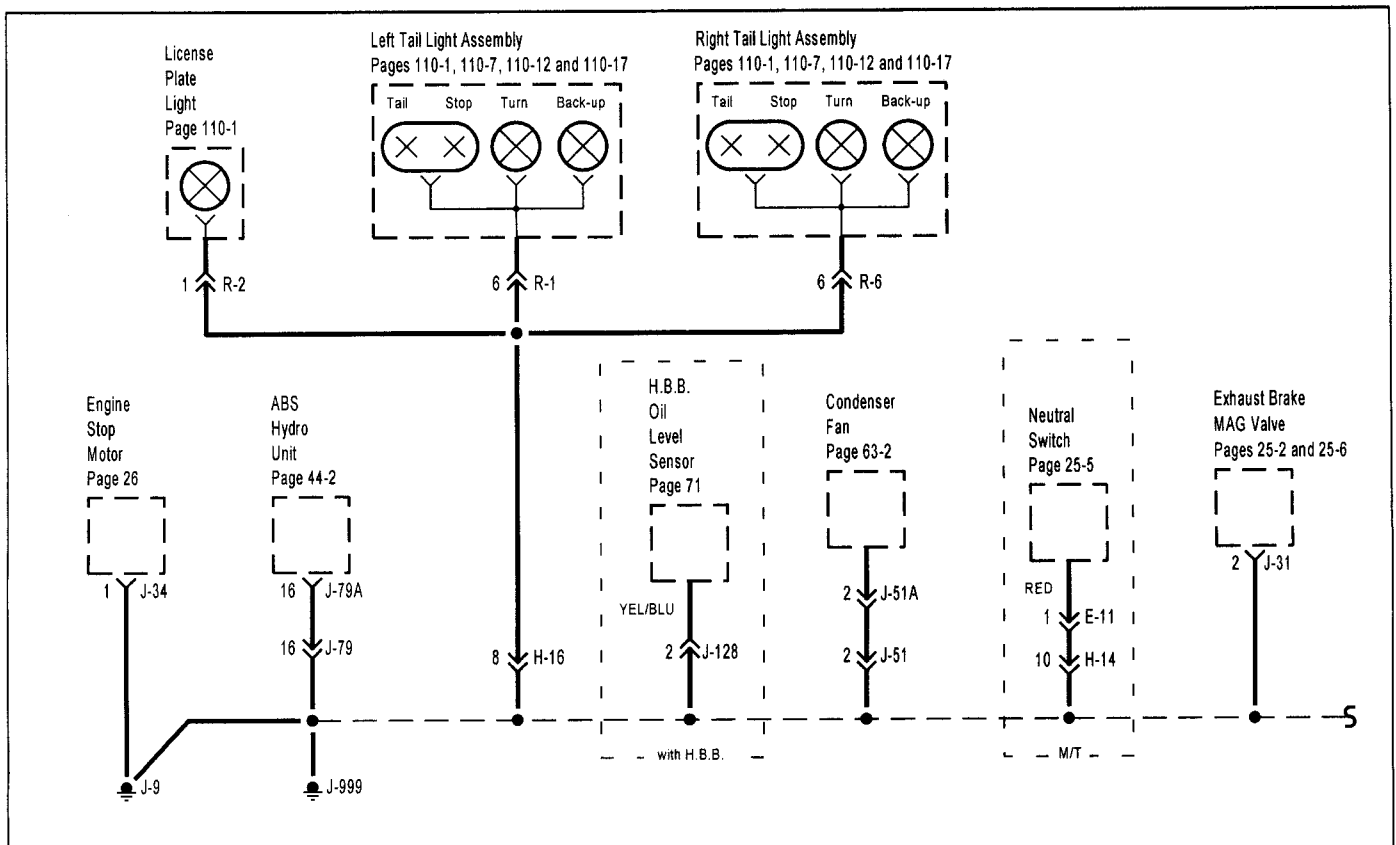

---

## Component Location

A component location index follows each schematic. Except for the location of obvious components like left headlight, the index lists the location of every component, connector and ground in the schematic. The index also gives references to component location photographs located in section 201. The number of cavities in each connector and the connector color is also listed. Wires may not be used in all connector cavities.

### Component Location Index

(Refer to Section 201 for photographs.)

<b><u>Component</u></b>	<b><u>Photo No.</u></b>
Fuse Box . . . . . Left side of dash, behind panel . . . . .	81
Left Horn . . . . . Left side of engine compartment, below headlight . . . . .	15
Right Horn . . . . . Right side of engine compartment, below headlight . . . . .	17
<b><u>Connector</u></b>	
B-2 (13-WHT) . . . . . Under left side of dash, above left side of steering column . . . . .	71
H-41 (16-GRN) . . . . . Under left side of dash, at kick panel . . . . .	63
<b><u>Ground</u></b>	
C-39 . . . . . Right rear corner of engine compartment . . . . .	42

# HOW TO USE THIS MANUAL

---

## Five-Step Troubleshooting

The following five-step troubleshooting procedure is recommended:

### 1. Verify the Problem

Check the problem circuit's operation to be sure you understand what's wrong. Do not begin disassembly or testing until you have narrowed down the possible causes.

If the system you are troubleshooting has a built-in self-diagnostic system, refer to the appropriate section of the Service Manual.

### 2. Analyze the Circuit Schematic

Analyze the schematic. Read the Circuit Operation text if you do not understand how the circuit should work. Check circuits that share the wiring with the problem circuit. The names of circuits that share the same fuse, ground, switch, etc., are included on each electrical schematic. Shared circuits are also shown on Power Distribution, Ground Distribution, Dash Fuse Box, and Lighting Switch Details pages. Try to operate the shared circuits. If these circuits work, then the shared wiring is OK. The cause must be within the wiring used only by the problem circuit. If several circuits fail at the same time, chances are the power (fuse) or ground circuit is faulty.

### 3. Find the Cause

- narrow down the possible causes
- use the troubleshooting hints
- make the necessary measurements as given in the troubleshooting procedures
- before you replace a component, check power, signal, and ground wires at the component harness connector

### 4. Repair the Problem

Once the specific problem is identified, make the repair. Be sure to use proper tools and always observe safe procedures.

### 5. Check the Repair

Check the repaired circuit's operation in all modes to make sure that you've fixed the entire problem. If the problem was a blown fuse, test all circuits on that fuse. Make sure that no new problems turn up.

## Test Equipment

### Voltmeter and Test Light

Use a voltmeter or test light to check for voltage. While a test light shows whether or not voltage is present, a voltmeter indicates how much voltage there is.

**CAUTION: A number of circuits include solid state devices. Voltages in these circuits should be tested only with a 10-megaohm or higher impedance digital multimeter. Never use a test light on circuits that contain solid-state devices. Damage to the device may result.**

On circuits without solid-state devices, a test light may be used to check for voltage. A test light is made up of a 12-volt bulb with a pair of leads attached. After grounding one lead, touch the other lead to various points along the circuit where voltage should be present. The bulb will go on if the voltage at the point being tested is greater than 5 volts.

### Self-Powered Test Light and Ohmmeter

Use a self-powered test light or ohmmeter to check for continuity. The ohmmeter shows how much resistance there is between two points along a circuit. Low resistance means good continuity.

**CAUTION: Never use a self-powered test light on circuits that contain solid-state devices. Damage to these devices may result.**

Diodes and solid-state devices in a circuit can make an ohmmeter give a false reading. To find out if a component is affecting a measurement, take one reading, reverse the leads, and take a second reading. If the readings differ, the component is affecting the measurement.

Circuits that contain solid-state devices should only be tested with a 10-megaohm or higher impedance digital multimeter.

## Troubleshooting Tests

A self-powered test light consists of a light bulb, battery and two leads. If the leads are touched together, the bulb will go on.

### Self-Powered Test Light

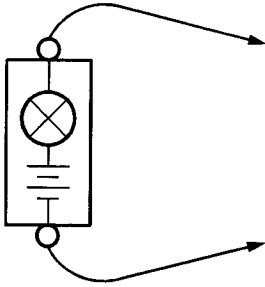

A self-powered test light is only used on an un-powered circuit. First disconnect the battery or remove the fuse that feeds the circuit you are working on. Select two points along the circuit through which there should have continuity. Connect one lead of the self-powered test light to each point. If there is continuity, the test light's circuit will be completed and the bulb will go on.

### Fused Jumper Wire

Use a jumper wire to bypass an open circuit. A jumper wire is made up of an in-line fuse holder connected to a set of test leads. It should have a five ampere fuse. Never use a jumper wire across any load. This direct battery short will blow the fuse.

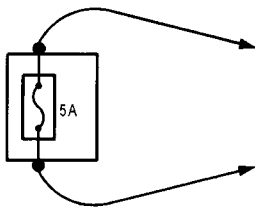

### Short Finder

Short finders are available to locate shorts to ground. The short finder creates a pulsing magnetic field in the shorted circuit and shows you the location of the short through body trim or sheet metal. Its use is explained in the following troubleshooting tests.

### Testing For Voltage

This test measures voltage in a circuit. When testing for voltage at a connector, you may not have to separate the two halves of the connector. Instead, probe the connector from the back. Always check both sides of the connector because dirt and corrosion between its contact surfaces can cause electrical problems.

1. Connect one lead of test light to known good ground, or if you are using a voltmeter, be sure you connect its negative lead to ground.
2. Connect the other lead of the test light or voltmeter to the point you want to check.
3. If the test light glows, there is voltage present. If you are using a voltmeter, note the voltage reading. It should be within one volt of measured battery voltage. A loss of more than one volt indicates a problem.

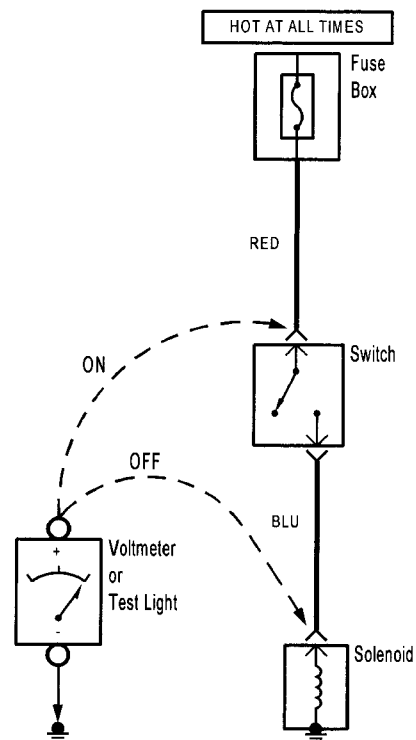

# HOW TO USE THIS MANUAL

## Troubleshooting Tests (cont'd)

### Testing For Continuity

This test checks for continuity within a circuit. When testing for continuity at a connector, you may not have to separate the two halves of the connector. Instead, probe the connector from the back. Always check both sides of the connector because dirt and corrosion between contact surfaces can cause electrical problems.

1. Disconnect the negative cable from the car battery.
2. If you are using an ohmmeter, hold the leads together and adjust the ohmmeter to read zero ohms.
3. Connect one lead of self-powered test light or ohmmeter to one end of the part of the circuit you wish to test.
4. Connect the other lead to the other end.
5. If the self-powered test light glows, there is continuity. If you're using an ohmmeter, low or no resistance means good continuity.

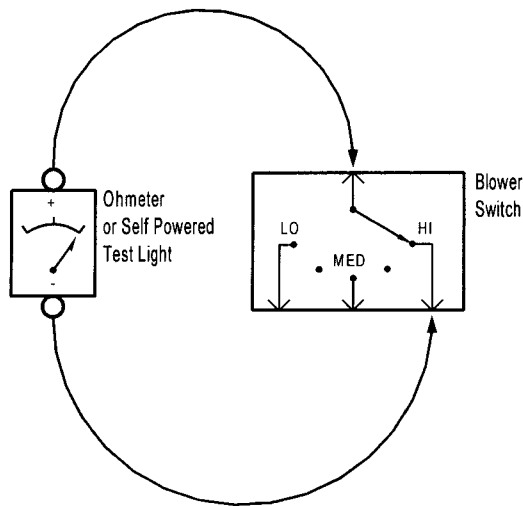

### Testing For Voltage Drop

This test checks for voltage drop along a wire, or through a connection or switch.

1. Connect the positive lead of a voltmeter to the end of the wire (or to the side of the connector or switch) closest to the battery.
2. Connect the negative lead to the other end of the wire (or the other side of the connector or switch).
3. Operate the circuit.
4. The voltmeter will show the difference in voltage between the two points. A difference, or drop of more than 0.5 volts may indicate a problem. Check the circuit for loose or dirty connections.

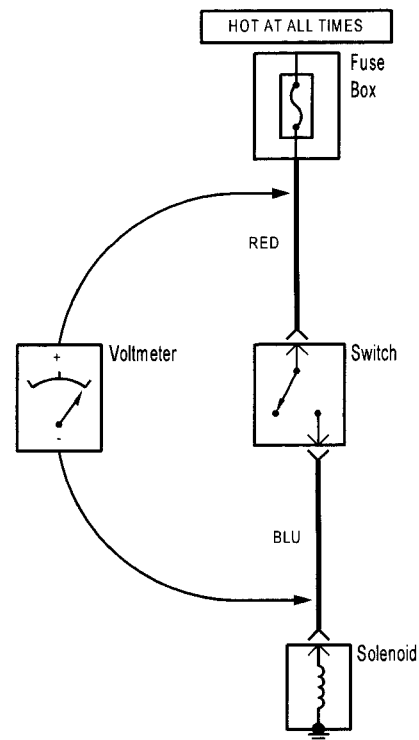

### Testing For A Short To Ground With A Test Light Or Voltmeter

1. Remove the blown fuse and disconnect the load.
2. Connect a test light or voltmeter across the fuse terminals. Make sure voltage is being applied to the battery side fuse terminal. Check schematic to see if the ignition switch needs to be in RUN.
3. Beginning near the fuse box, wiggle the harness. Continue this at convenient points about six inches apart while watching the test light or voltmeter.
4. When the test light blinks or the voltmeter needle moves, there is a short to ground in the wiring near that point.

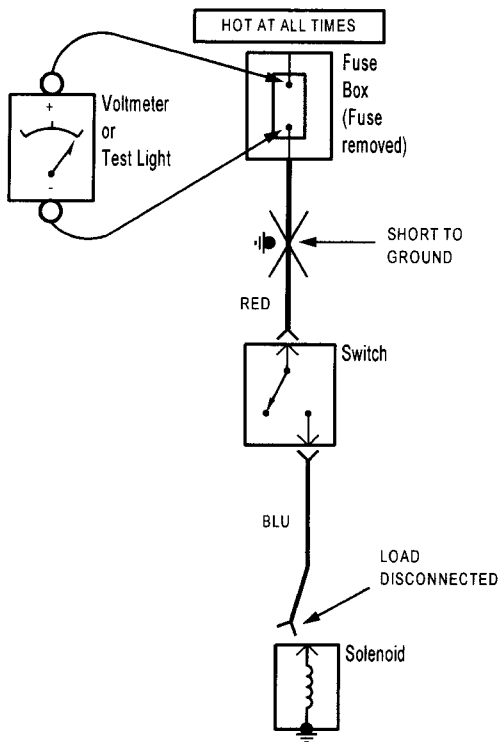

### Testing For A Short To Ground With A Self-Powered Test Light Or Ohmmeter

1. Remove the blown fuse and disconnect the battery and load.
2. Connect one lead of a self-powered test light or ohmmeter to the fuse terminal load side.
3. Connect the other lead to a known good ground.
4. Beginning near the fuse box, wiggle the harness. Continue this at convenient points about six inches apart while watching the test light or ohmmeter.
5. If the self-powered test light blinks or the ohmmeter needle moves, there is a short to ground in the wiring near that point.

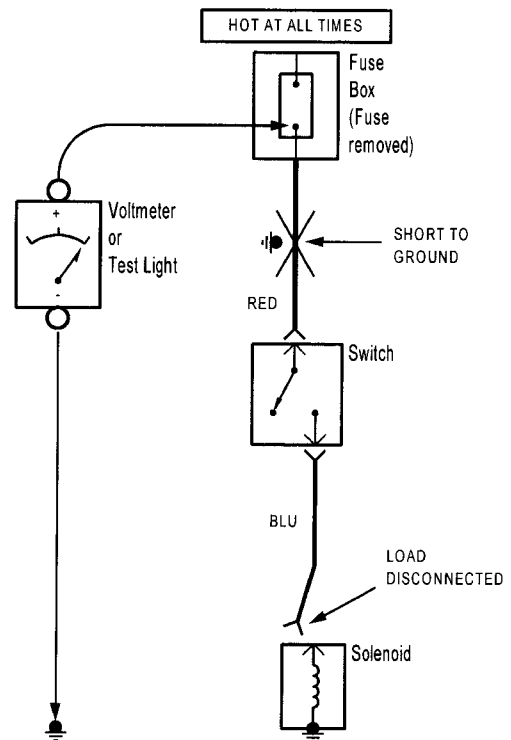



# HOW TO USE THIS MANUAL

## Troubleshooting Tests (cont'd)

### Testing For A Short To Ground With A Short Finder

1. With the battery connected, remove the blown fuse.
2. Connect the short finder between the positive battery terminal and the load side fuse terminal.
3. Close all switches in series with the wire that you are troubleshooting.
4. Turn on the short finder. This will send pulses of current to the short and create a pulsing magnetic field around the wiring between the fuse box and the short.
5. Beginning at the fuse box, slowly move the short finder meter along the circuit wiring. The meter will show current pulses through sheet metal and body trim. As long as the meter is between the fuse and the short, the needle will move with each current pulse. Once you move the meter past the point of the short, the needle will stop moving. Check around this area to locate the cause of the short circuit.

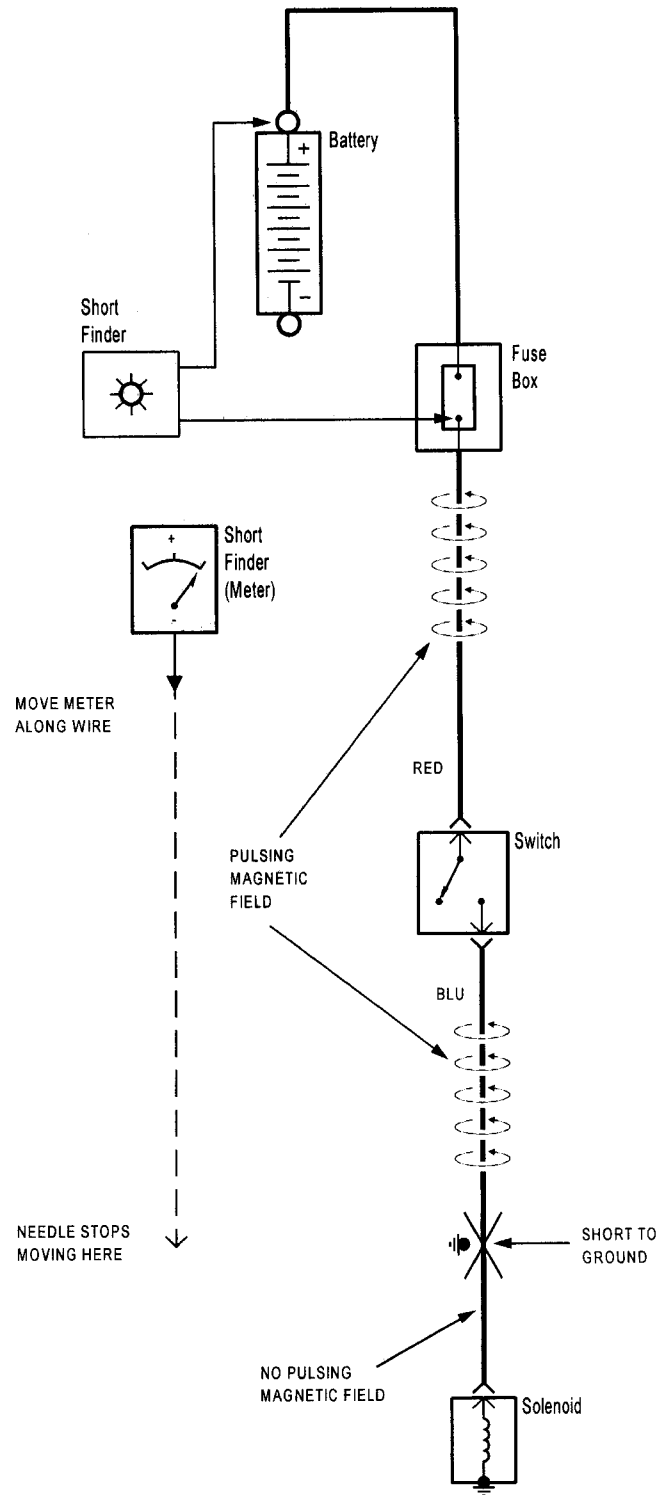



# FUSE/RELAY INFORMATION

## Relay Box

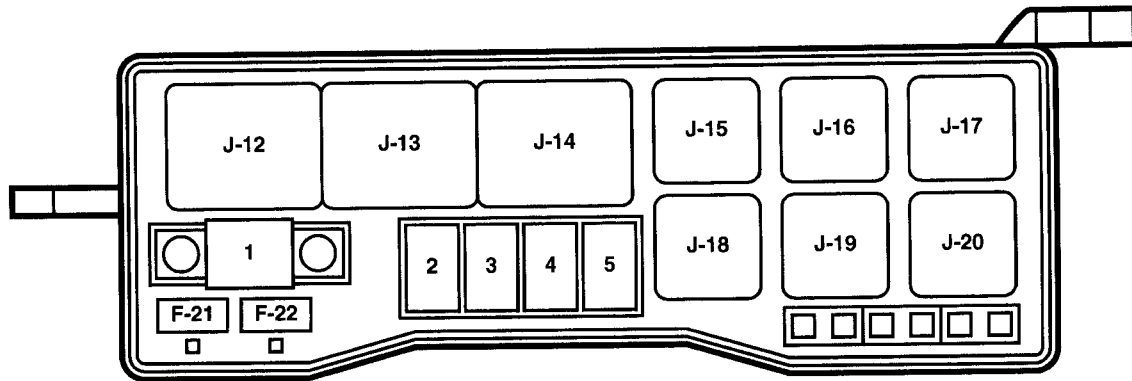

Fuse Number	Fuse Name	Amps	Circuit Protected
1	MAIN	80A	Power distribution
2	KEY	50A	Power distribution
3	ABS (Gas)	60A	ABS (Gas), Engine controls (Diesel)
	GLOW (Diesel)		
4	ABS (Diesel)	60A	ABS
5	C/HEATER (Diesel)	60A	Ceramic heater
F-21	—	—	Not used
F-22	CONDENSER FAN (Diesel)	15A	Condenser fan

Relay Number	Relay
J-12	Starter
J-13	Glow-1 (Diesel)
J-14	C/Heater (Diesel M/T)
J-15	Warm cut 1 (Diesel)
	A/C enable (Gas)

Relay Number	Relay
J-16	Fuel pump (Gas)
J-17	Condenser (Diesel)
J-18	Exhaust brake control (Diesel)
J-19	Engine warm cut 2 (Diesel A/T)
J-20	I.D. light relay

**Fuse Box**

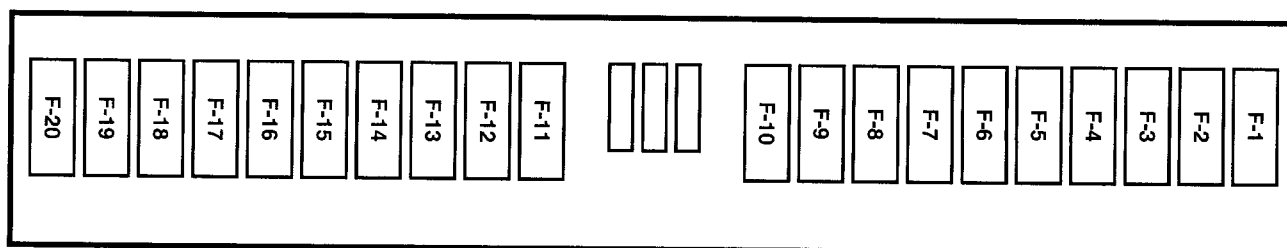

Fuse Number	Fuse Name	Amps	Circuit Protected
F-1	HEATER	25A	Heater
F-2	AIR CON	10A	Compressor Controls
F-3	EXHAUST BRAKE (Diesel)	10A	Exhaust Brake System (Diesel)
	VCM (IGN) (Gas)		Engine Controls (Gas)
F-4	D.R.L. (Diesel)	10A	Headlights (Diesel)
	ENGINE (IGN) (Gas)		Engine Controls (Gas)
F-5	ECU (BAT) (Diesel)	10A	Engine Controls (Diesel)
	A/T SOLENOID (GAS)		Automatic Transmission Controls (Gas)
F-6	DOME LIGHT	10A	Interior Lights, Exterior Lights, Sound System (Gas), Speedometer (Gas)
F-7	TAIL LIGHT	10A	Dash Lights, Exterior Lights
F-8	STOP LIGHT	10A	Brake Lights
F-9	HEAD LIGHT (RH)	20A	Headlights
F-10	HEAD LIGHT (LH)	20A	Headlights
F-11	WIPER, WASHER	20A	Windshield Wiper/Washer
F-12	GENERATOR	20A	Charging System
F-13	TURN S/LIGHT	10A	Turn Lights
F-14	ECU (IGN) (Diesel)	10A	Engine Controls
	VCM (ACC) (Gas)		
F-15	AUDIO, CIGAR LIGHTER	20A	Cigarette Lighter, Engine Controls, Sound System
F-16	POWER SOURCE	20A	Engine Controls
F-17	ENGINE STOP (Diesel)	10A	Engine Stop System (Diesel)
	FUEL PUMP (Gas)	10A	Engine Controls, Gauges (Gas)
F-18	HAZARD, HORN	20A	Engine Controls, Gauges, Horn, Hazard Lights
F-19	ABS (BAT)	25A	ABS
F-20	STARTER	10A	Starting System