

Hyundai Elantra 1996 2001 Manual Repair Haynes Optimized

Full download: <http://manualplace.com/download/hyundai-elantra-1996-2001-manual-repair-haynes-optimized/>

# Hyundai Elantra

1996 thru 2001 □ All models



# Haynes Repair Manual

*Based on a complete teardown and rebuild*



*Includes essential information for today's more complex vehicles*

This is the cut pages sample. Download all 275 page(s) at: [ManualPlace.com](http://ManualPlace.com)

# Hyundai Elantra Automotive Repair Manual

---

by **Larry Warren,  
Mike Stubblefield  
and John H Haynes**

Member of the Guild of Motoring Writers

---

**Models covered:**

All Hyundai Elantra models - 1996 through 2001

---



ABCDE  
FGHIJ  
KLMNO  
PQRST

**Haynes Publishing Group**  
Sparkford Nr Yeovil  
Somerset BA22 7JJ England

**Haynes North America, Inc**  
861 Lawrence Drive  
Newbury Park  
California 91320 USA



---

### **Acknowledgements**

Wiring diagrams originated exclusively for Haynes North America, Inc.  
by Valley Forge Technical Information Services

---

© Haynes North America, Inc. 2002

With permission from J.H. Haynes & Co. Ltd.

---

**A book in the Haynes Automotive Repair Manual Series**

---

**Printed in the U.S.A.**

---

All rights reserved. No part of this book may be reproduced or transmitted  
in any form or by any means, electronic or mechanical, including photo-  
copying, recording or by any information storage or retrieval system,  
without permission in writing from the copyright holder.

---

**ISBN 1 56392 451 X**

---

**Library of Congress Control Number 2001097037**

---

While every attempt is made to ensure that the information in this manual  
is correct, no liability can be accepted by the authors or publishers for  
loss, damage or injury caused by any errors in, or omissions from, the  
information given.

---

# Contents

## Introductory pages

About this manual	0-5	
Introduction to the Hyundai Elantra	0-5	
Vehicle identification numbers	0-6	
Buying parts	0-7	
Maintenance techniques, tools and working facilities	0-7	
Booster battery (jump) starting	0-15	
Jacking and towing	0-16	
Automotive chemicals and lubricants	0-17	
Conversion factors	0-18	
Fraction/decimal/millimeter equivalents	0-19	
Safety first!	0-20	
Troubleshooting	0-21	
<hr/>		
<b>Chapter 1</b>		<b>1</b>
Tune-up and routine maintenance	1-1	
<hr/>		
<b>Chapter 2 Part A</b>		<b>2A</b>
Engine	2A-1	
<hr/>		
<b>Chapter 2 Part B</b>		<b>2B</b>
General engine overhaul procedures	2C-1	
<hr/>		
<b>Chapter 3</b>		<b>3</b>
Cooling, heating and air conditioning systems	3-1	
<hr/>		
<b>Chapter 4</b>		<b>4</b>
Fuel and exhaust systems	4-1	
<hr/>		
<b>Chapter 5</b>		<b>5</b>
Engine electrical systems	5-1	
<hr/>		
<b>Chapter 6</b>		<b>6</b>
Emissions and engine control systems	6-1	
<hr/>		
<b>Chapter 7 Part A</b>		<b>7A</b>
Manual transaxle	7A-1	
<hr/>		
<b>Chapter 7 Part B</b>		<b>7B</b>
Automatic transaxle	7B-1	
<hr/>		
<b>Chapter 8</b>		<b>8</b>
Clutch and driveline	8-1	
<hr/>		
<b>Chapter 9</b>		<b>9</b>
Brakes	9-1	
<hr/>		
<b>Chapter 10</b>		<b>10</b>
Suspension and steering systems	10-1	
<hr/>		
<b>Chapter 11</b>		<b>11</b>
Body	11-1	
<hr/>		
<b>Chapter 12</b>		<b>12</b>
Chassis electrical system	12-1	
<hr/>		
<b>Wiring diagrams</b>	12-15	
<hr/>		
<b>Index</b>	IND-1	<b>IND</b>

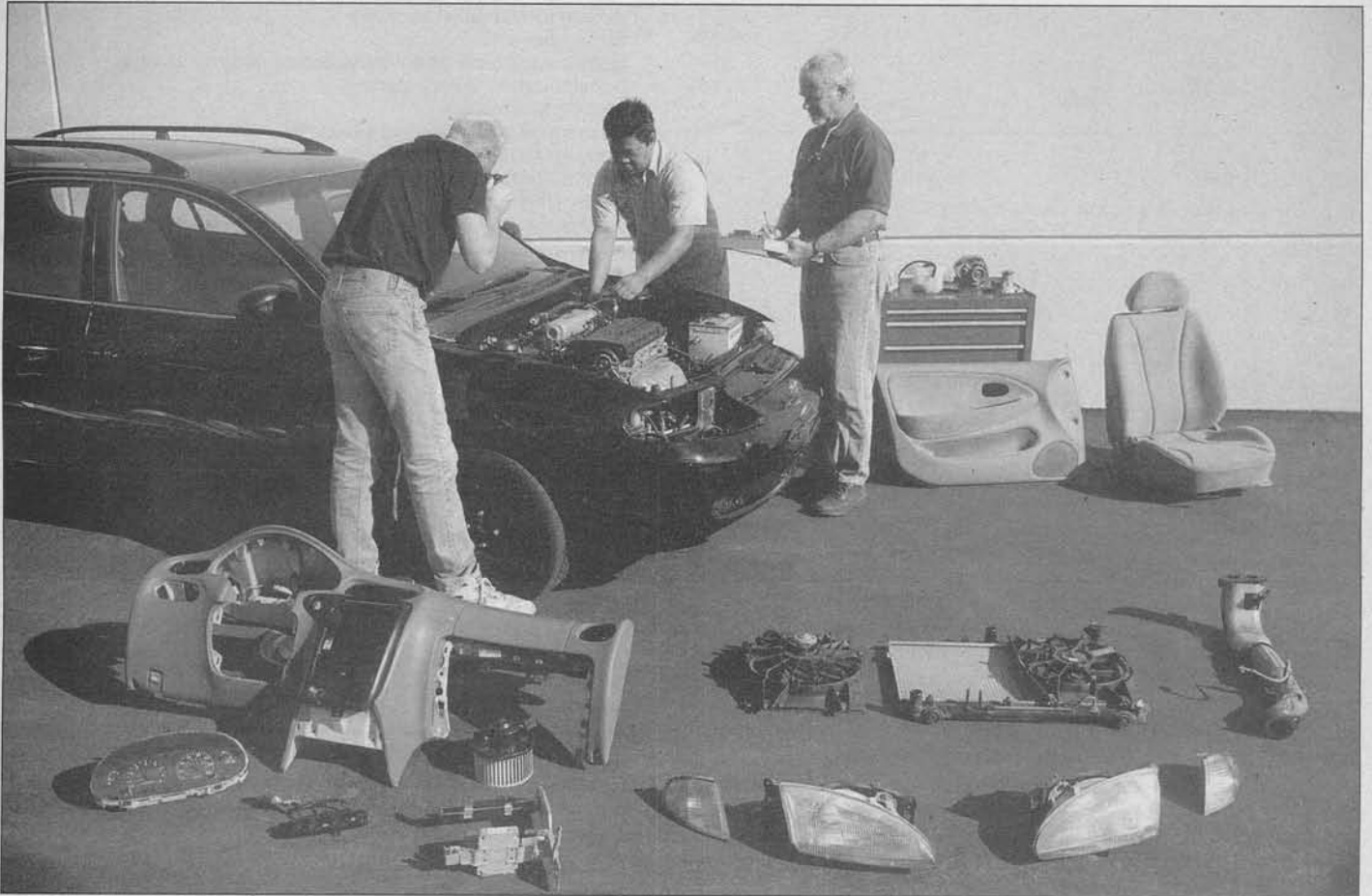

Haynes author, mechanic and photographer with 1996 Hyundai Elantra

## About this manual

---

### *Its purpose*

The purpose of this manual is to help you get the best value from your vehicle. It can do so in several ways. It can help you decide what work must be done, even if you choose to have it done by a dealer service department or a repair shop; it provides information and procedures for routine maintenance and servicing; and it offers diagnostic and repair procedures to follow when trouble occurs.

We hope you use the manual to tackle the work yourself. For many simpler jobs, doing it yourself may be quicker than arranging an appointment to get the vehicle into a shop and making the trips to leave it and pick it up. More importantly, a lot of money can be saved by avoiding the expense the shop

must pass on to you to cover its labor and overhead costs. An added benefit is the sense of satisfaction and accomplishment that you feel after doing the job yourself.

### *Using the manual*

The manual is divided into Chapters. Each Chapter is divided into numbered Sections, which are headed in bold type between horizontal lines. Each Section consists of consecutively numbered paragraphs.

At the beginning of each numbered Section you will be referred to any illustrations which apply to the procedures in that Section. The reference numbers used in illustration captions pinpoint the pertinent Section and the Step within that Section. That is, illustration 3.2 means the illustration refers to Section 3 and Step (or paragraph) 2 within

that Section.

Procedures, once described in the text, are not normally repeated. When it's necessary to refer to another Chapter, the reference will be given as Chapter and Section number. Cross references given without use of the word "Chapter" apply to Sections and/or paragraphs in the same Chapter. For example, "see Section 8" means in the same Chapter.

References to the left or right side of the vehicle assume you are sitting in the driver's seat, facing forward.

Even though we have prepared this manual with extreme care, neither the publisher nor the author can accept responsibility for any errors in, or omissions from, the information given.

---

### **NOTE**

A **Note** provides information necessary to properly complete a procedure or information which will make the procedure easier to understand.

### **CAUTION**

A **Caution** provides a special procedure or special steps which must be taken while completing the procedure where the Caution is found. Not heeding a Caution can result in damage to the assembly being worked on.

### **WARNING**

A **Warning** provides a special procedure or special steps which must be taken while completing the procedure where the Warning is found. Not heeding a Warning can result in personal injury.

---

## Introduction to the Hyundai Elantra

---

These models are available in four-door sedan body, four-door hatchback and station wagon body styles.

The transversely mounted inline four-cylinder engines used in these models are equipped with electronic fuel injection.

The engine drives the front wheels through either a five-speed manual or a four-speed automatic transaxle via independent driveaxles.

Independent suspension, featuring MacPherson struts, is used on all four

wheels. The power-assisted rack-and-pinion steering unit is mounted behind the engine.

The brakes at the front are discs and either disc or drum at the rear, with standard power assist. Some models are equipped with Anti-lock Braking Systems (ABS).



## Vehicle identification numbers

Modifications are a continuing and unpublicized process in vehicle manufacturing. Since spare parts manuals and lists are compiled on a numerical basis, the individual vehicle numbers are essential to correctly identify the component required.

### Vehicle identification number (VIN)

This very important number stamped on a plate attached to the dashboard inside the windshield on the driver's side of the vehicle (see illustration) It is also stamped on the firewall in the engine compartment and on a plate on the drivers side door (see illustrations). The VIN also appears on the Vehicle Certificate of Title and Registration. It contains information such as where and when the vehicle was manufactured, the model year and the body style.

### VIN Engine and model year codes

Two particularly important pieces of information found in the VIN are the engine

code and model year code. Counting from the left, the engine code designation is the eighth digit. The model year code is the 10th digit.

#### Model year codes

T = 1996  
V = 1997  
W = 1998  
X = 1999  
Y = 2000  
1 = 2001

#### Engine codes

M = 1.8L DOHC four-cylinder engine  
F = 2.0L DOHC four-cylinder engine

The engine code number is commonly needed when ordering engine parts. Besides being a component of the VIN, an engine code can also be found on the front (radiator) side of the engine on the right (passenger's side) end below the oil filter.

### Transaxle number

The transaxle number is commonly needed when ordering transaxle parts. On

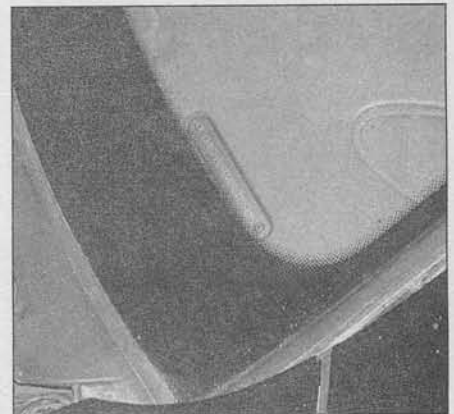

The Vehicle Identification Number (VIN) is stamped into a metal plate fastened to the dashboard on the driver's side - it is visible through the windshield

manual transaxles it's located on the transaxle case. On automatic transaxles, it's found on a tag on the front of the transaxle case.



The Vehicle Identification Number (VIN) is also stamped into firewall in the engine compartment



The VIN can also be found on the end of the driver's door

## Buying parts

Replacement parts are available from many sources, which generally fall into one of two categories - authorized dealer parts departments and independent retail auto parts stores. Our advice concerning these parts is as follows:

**Retail auto parts stores:** Good auto parts stores will stock frequently needed components which wear out relatively fast, such as clutch components, exhaust systems, brake parts, tune-up parts, etc. These stores often supply new or reconditioned

parts on an exchange basis, which can save a considerable amount of money. Discount auto parts stores are often very good places to buy materials and parts needed for general vehicle maintenance such as oil, grease, filters, spark plugs, belts, touch-up paint, bulbs, etc. They also usually sell tools and general accessories, have convenient hours, charge lower prices and can often be found not far from home.

**Authorized dealer parts department:** This is the best source for parts which are

unique to the vehicle and not generally available elsewhere (such as major engine parts, transmission parts, trim pieces, etc.).

**Warranty information:** If the vehicle is still covered under warranty, be sure that any replacement parts purchased - regardless of the source - do not invalidate the warranty!

To be sure of obtaining the correct parts, have engine and chassis numbers available and, if possible, take the old parts along for positive identification.

## Maintenance techniques, tools and working facilities

### Maintenance techniques

There are a number of techniques involved in maintenance and repair that will be referred to throughout this manual. Application of these techniques will enable the home mechanic to be more efficient, better organized and capable of performing the various tasks properly, which will ensure that the repair job is thorough and complete.

### Fasteners

Fasteners are nuts, bolts, studs and screws used to hold two or more parts together. There are a few things to keep in mind when working with fasteners. Almost all of them use a locking device of some type, either a lockwasher, locknut, locking tab or thread adhesive. All threaded fasteners should be clean and straight, with undamaged threads and undamaged corners on the hex head where the wrench fits. Develop the habit of replacing all damaged nuts and bolts with new ones. Special locknuts with nylon or fiber inserts can only be used once. If they are removed, they lose their locking ability and must be replaced with new ones.

Rusted nuts and bolts should be treated with a penetrating fluid to ease removal and prevent breakage. Some mechanics use turpentine in a spout-type oil can, which works quite well. After applying the rust penetrant, let it work for a few minutes before trying to loosen the nut or bolt. Badly rusted fasteners

may have to be chiseled or sawed off or removed with a special nut breaker, available at tool stores.

If a bolt or stud breaks off in an assembly, it can be drilled and removed with a special tool commonly available for this purpose. Most automotive machine shops can perform this task, as well as other repair procedures, such as the repair of threaded holes that have been stripped out.

Flat washers and lockwashers, when removed from an assembly, should always be replaced exactly as removed. Replace any damaged washers with new ones. Never use a lockwasher on any soft metal surface (such as aluminum), thin sheet metal or plastic.

### Fastener sizes

For a number of reasons, automobile manufacturers are making wider and wider use of metric fasteners. Therefore, it is important to be able to tell the difference between standard (sometimes called U.S. or SAE) and metric hardware, since they cannot be interchanged.

All bolts, whether standard or metric, are sized according to diameter, thread pitch and length. For example, a standard 1/2 - 13 x 1 bolt is 1/2 inch in diameter, has 13 threads per inch and is 1 inch long. An M12 - 1.75 x 25 metric bolt is 12 mm in diameter, has a thread pitch of 1.75 mm (the distance between threads) and is 25 mm long. The two bolts are

nearly identical, and easily confused, but they are not interchangeable.

In addition to the differences in diameter, thread pitch and length, metric and standard bolts can also be distinguished by examining the bolt heads. To begin with, the distance across the flats on a standard bolt head is measured in inches, while the same dimension on a metric bolt is sized in millimeters (the same is true for nuts). As a result, a standard wrench should not be used on a metric bolt and a metric wrench should not be used on a standard bolt. Also, most standard bolts have slashes radiating out from the center of the head to denote the grade or strength of the bolt, which is an indication of the amount of torque that can be applied to it. The greater the number of slashes, the greater the strength of the bolt. Grades 0 through 5 are commonly used on automobiles. Metric bolts have a property class (grade) number, rather than a slash, molded into their heads to indicate bolt strength. In this case, the higher the number, the stronger the bolt. Property class numbers 8.8, 9.8 and 10.9 are commonly used on automobiles.

Strength markings can also be used to distinguish standard hex nuts from metric hex nuts. Many standard nuts have dots stamped into one side, while metric nuts are marked with a number. The greater the number of dots, or the higher the number, the greater the strength of the nut.



Metric studs are also marked on their ends according to property class (grade). Larger studs are numbered (the same as metric bolts), while smaller studs carry a geometric code to denote grade.

It should be noted that many fasteners, especially Grades 0 through 2, have no distinguishing marks on them. When such is the case, the only way to determine whether it is standard or metric is to measure the thread pitch or compare it to a known fastener of the same size.

Standard fasteners are often referred to as SAE, as opposed to metric. However, it should be noted that SAE technically refers to a non-metric fine thread fastener only. Coarse thread non-metric fasteners are referred to as USS sizes.

Since fasteners of the same size (both standard and metric) may have different strength ratings, be sure to reinstall any bolts, studs or nuts removed from your vehicle in their original locations. Also, when replacing a fastener with a new one, make sure that the new one has a strength rating equal to or greater than the original.

**Tightening sequences and procedures**

Most threaded fasteners should be tightened to a specific torque value (torque is the twisting force applied to a threaded component such as a nut or bolt). Overtightening the fastener can weaken it and cause it to break, while undertightening can cause it to eventually come loose. Bolts, screws and

studs, depending on the material they are made of and their thread diameters, have specific torque values, many of which are noted in the Specifications at the beginning of each Chapter. Be sure to follow the torque recommendations closely. For fasteners not assigned a specific torque, a general torque value chart is presented here as a guide. These torque values are for dry (unlubricated) fasteners threaded into steel or cast iron (not aluminum). As was previously mentioned, the size and grade of a fastener determine the amount of torque that can safely be applied to it. The figures listed here are approximate for Grade 2 and Grade 3 fasteners. Higher grades can tolerate higher torque values.

Fasteners laid out in a pattern, such as cylinder head bolts, oil pan bolts, differential

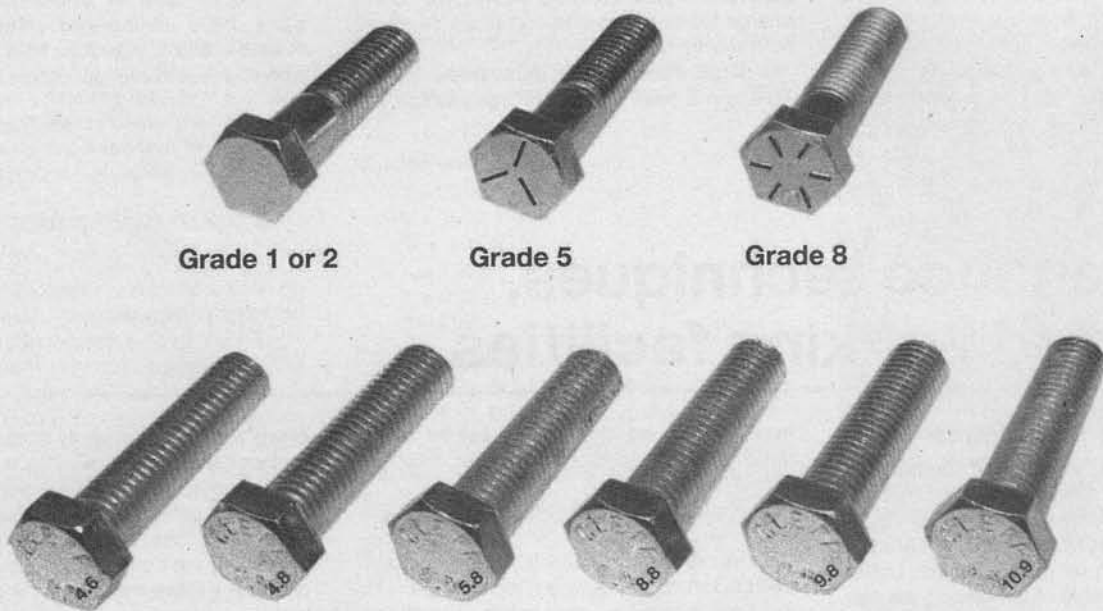

Bolt strength marking (standard/SAE/USS; bottom - metric)

Grade	Identification	Grade	Identification
Hex Nut Grade 5	3 Dots	Hex Nut Property Class 9	Arabic 9
Hex Nut Grade 8	6 Dots	Hex Nut Property Class 10	Arabic 10

Standard hex nut strength markings

Metric hex nut strength markings

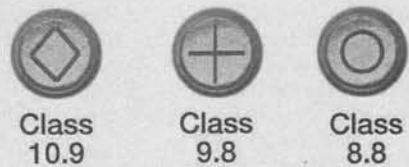

Metric stud strength markings

cover bolts, etc., must be loosened or tightened in sequence to avoid warping the component. This sequence will normally be shown in the appropriate Chapter. If a specific pattern is not given, the following procedures can be used to prevent warping.

Initially, the bolts or nuts should be assembled finger-tight only. Next, they should be tightened one full turn each, in a criss-cross or diagonal pattern. After each one has been tightened one full turn, return to the first one and tighten them all one-half turn, following the same pattern. Finally,

tighten each of them one-quarter turn at a time until each fastener has been tightened to the proper torque. To loosen and remove the fasteners, the procedure would be reversed.

**Component disassembly**

Component disassembly should be done with care and purpose to help ensure that the parts go back together properly. Always keep track of the sequence in which parts are removed. Make note of special characteristics or marks on parts that can be installed more than one way, such as a

grooved thrust washer on a shaft. It is a good idea to lay the disassembled parts out on a clean surface in the order that they were removed. It may also be helpful to make sketches or take instant photos of components before removal.

When removing fasteners from a component, keep track of their locations. Sometimes threading a bolt back in a part, or putting the washers and nut back on a stud, can prevent mix-ups later. If nuts and bolts cannot be returned to their original locations, they should be kept in a compartmented box or a

**Metric thread sizes**

	<b>Ft-lbs</b>	<b>Nm</b>
M-6 .....	6 to 9	9 to 12
M-8 .....	14 to 21	19 to 28
M-10 .....	28 to 40	38 to 54
M-12 .....	50 to 71	68 to 96
M-14 .....	80 to 140	109 to 154

**Pipe thread sizes**

1/8 .....	5 to 8	7 to 10
1/4 .....	12 to 18	17 to 24
3/8 .....	22 to 33	30 to 44
1/2 .....	25 to 35	34 to 47

**U.S. thread sizes**

1/4 - 20 .....	6 to 9	9 to 12
5/16 - 18 .....	12 to 18	17 to 24
5/16 - 24 .....	14 to 20	19 to 27
3/8 - 16 .....	22 to 32	30 to 43
3/8 - 24 .....	27 to 38	37 to 51
7/16 - 14 .....	40 to 55	55 to 74
7/16 - 20 .....	40 to 60	55 to 81
1/2 - 13 .....	55 to 80	75 to 108

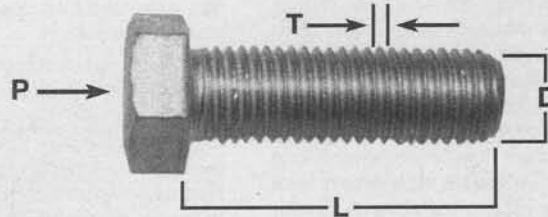
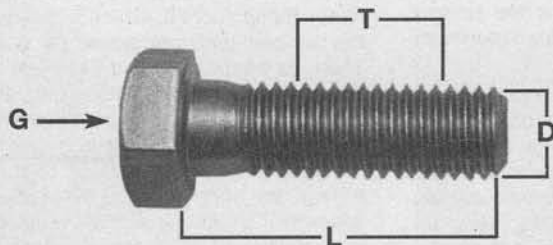

00-2 HAYNES

**Standard (SAE and USS) bolt dimensions/grade marks**

- G Grade marks (bolt strength)
- L Length (in inches)
- T Thread pitch (number of threads per inch)
- D Nominal diameter (in inches)

**Metric bolt dimensions/grade marks**

- P Property class (bolt strength)
- L Length (in millimeters)
- T Thread pitch (distance between threads in millimeters)
- D Diameter



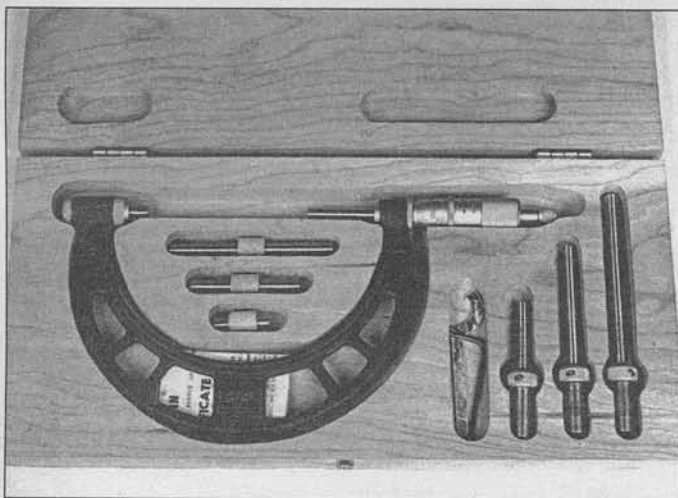

Micrometer set

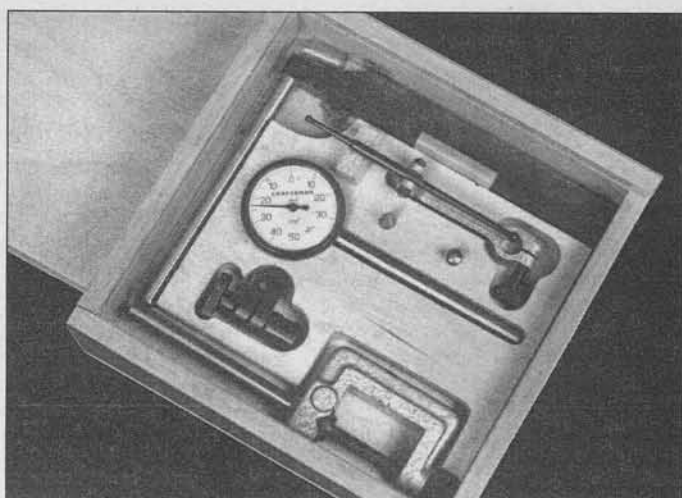

Dial indicator set

series of small boxes. A cupcake or muffin tin is ideal for this purpose, since each cavity can hold the bolts and nuts from a particular area (i.e. oil pan bolts, valve cover bolts, engine mount bolts, etc.). A pan of this type is especially helpful when working on assemblies with very small parts, such as the carburetor, alternator, valve train or interior dash and trim pieces. The cavities can be marked with paint or tape to identify the contents.

Whenever wiring looms, harnesses or connectors are separated, it is a good idea to identify the two halves with numbered pieces of masking tape so they can be easily reconnected.

### Gasket sealing surfaces

Throughout any vehicle, gaskets are used to seal the mating surfaces between two parts and keep lubricants, fluids, vacuum or pressure contained in an assembly.

Many times these gaskets are coated with a liquid or paste-type gasket sealing compound before assembly. Age, heat and pressure can sometimes cause the two parts to stick together so tightly that they are very difficult to separate. Often, the assembly can be loosened by striking it with a soft-face hammer near the mating surfaces. A regular hammer can be used if a block of wood is placed between the hammer and the part. Do not hammer on cast parts or parts that could be easily damaged. With any particularly stubborn part, always recheck to make sure that every fastener has been removed.

Avoid using a screwdriver or bar to pry apart an assembly, as they can easily mar the gasket sealing surfaces of the parts, which must remain smooth. If prying is absolutely necessary, use an old broom handle, but keep in mind that extra clean up will be necessary if the wood splinters.

After the parts are separated, the old gasket must be carefully scraped off and the gasket surfaces cleaned. Stubborn gasket material can be soaked with rust penetrant or treated with a special chemical to soften it so

it can be easily scraped off. A scraper can be fashioned from a piece of copper tubing by flattening and sharpening one end. Copper is recommended because it is usually softer than the surfaces to be scraped, which reduces the chance of gouging the part. Some gaskets can be removed with a wire brush, but regardless of the method used, the mating surfaces must be left clean and smooth. If for some reason the gasket surface is gouged, then a gasket sealer thick enough to fill scratches will have to be used during reassembly of the components. For most applications, a non-drying (or semi-drying) gasket sealer should be used.

### Hose removal tips

**Warning:** If the vehicle is equipped with air conditioning, do not disconnect any of the A/C hoses without first having the system depressurized by a dealer service department or a service station.

Hose removal precautions closely parallel gasket removal precautions. Avoid scratching or gouging the surface that the hose mates against or the connection may leak. This is especially true for radiator hoses. Because of various chemical reactions, the rubber in hoses can bond itself to the metal spigot that the hose fits over. To remove a hose, first loosen the hose clamps that secure it to the spigot. Then, with slip-joint pliers, grab the hose at the clamp and rotate it around the spigot. Work it back and forth until it is completely free, then pull it off. Silicone or other lubricants will ease removal if they can be applied between the hose and the outside of the spigot. Apply the same lubricant to the inside of the hose and the outside of the spigot to simplify installation.

As a last resort (and if the hose is to be replaced with a new one anyway), the rubber can be slit with a knife and the hose peeled from the spigot. If this must be done, be careful that the metal connection is not damaged.

If a hose clamp is broken or damaged, do not reuse it. Wire-type clamps usually

weaken with age, so it is a good idea to replace them with screw-type clamps whenever a hose is removed.

### Tools

A selection of good tools is a basic requirement for anyone who plans to maintain and repair his or her own vehicle. For the owner who has few tools, the initial investment might seem high, but when compared to the spiraling costs of professional auto maintenance and repair, it is a wise one.

To help the owner decide which tools are needed to perform the tasks detailed in this manual, the following tool lists are offered: *Maintenance and minor repair*, *Repair/overhaul* and *Special*.

The newcomer to practical mechanics should start off with the *maintenance and minor repair* tool kit, which is adequate for the simpler jobs performed on a vehicle. Then, as confidence and experience grow, the owner can tackle more difficult tasks, buying additional tools as they are needed. Eventually the basic kit will be expanded into the *repair and overhaul* tool set. Over a period of time, the experienced do-it-yourselfer will assemble a tool set complete enough for most repair and overhaul procedures and will add tools from the special category when it is felt that the expense is justified by the frequency of use.

### Maintenance and minor repair tool kit

The tools in this list should be considered the minimum required for performance of routine maintenance, servicing and minor repair work. We recommend the purchase of combination wrenches (box-end and open-end combined in one wrench). While more expensive than open end wrenches, they offer the advantages of both types of wrench.

- Combination wrench set (1/4-inch to 1 inch or 6 mm to 19 mm)
- Adjustable wrench, 8 inch
- Spark plug wrench with rubber insert



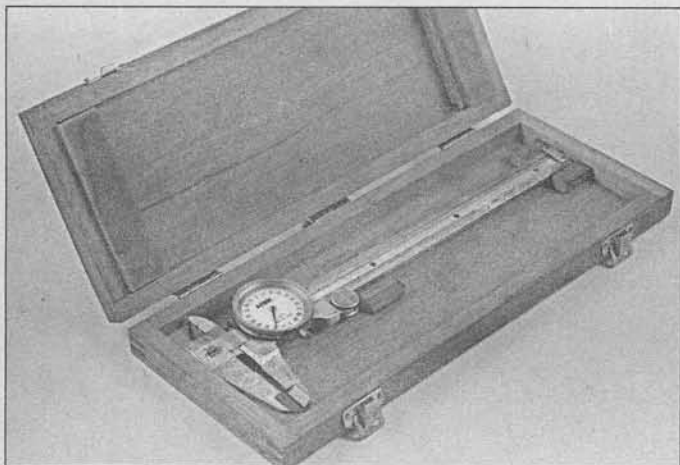

Dial caliper

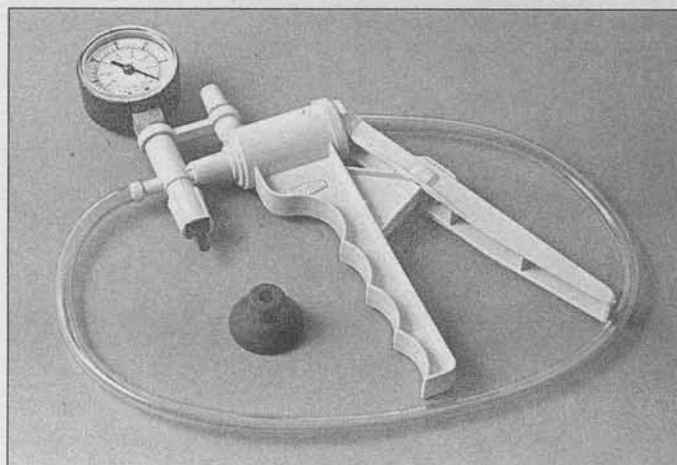

Hand-operated vacuum pump



Timing light

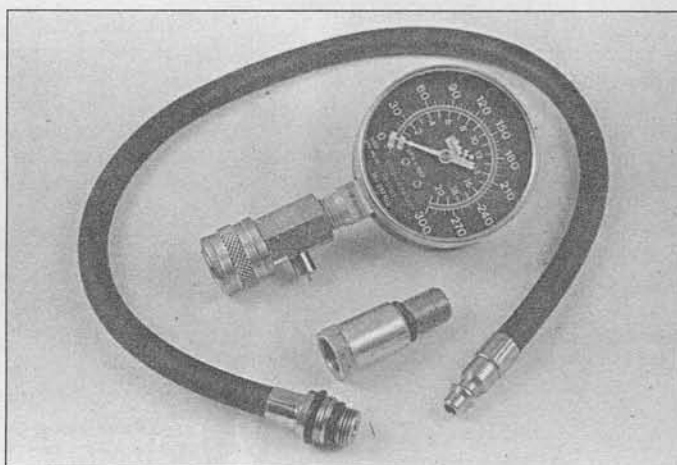

Compression gauge with spark plug hole adapter

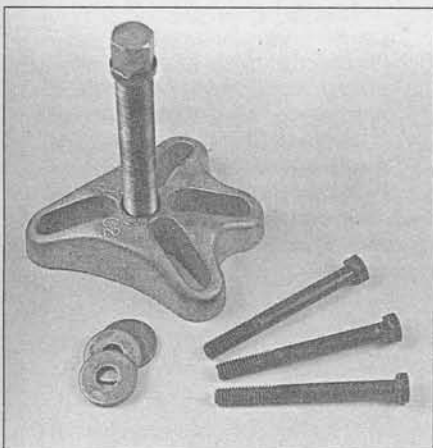

Damper/steering wheel puller

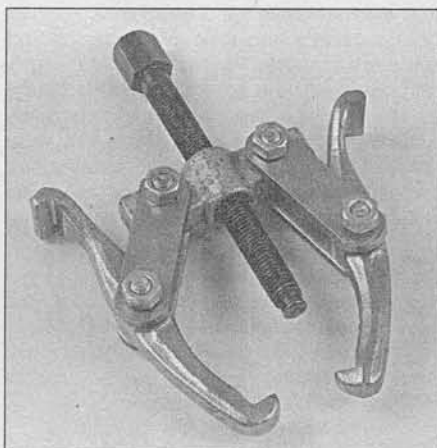

General purpose puller



Hydraulic lifter removal tool

- Spark plug gap adjusting tool
- Feeler gauge set
- Brake bleeder wrench
- Standard screwdriver (5/16-inch x 6 inch)
- Phillips screwdriver (No. 2 x 6 inch)
- Combination pliers - 6 inch
- Hacksaw and assortment of blades

- Tire pressure gauge
- Grease gun
- Oil can
- Fine emery cloth
- Wire brush
- Battery post and cable cleaning tool
- Oil filter wrench
- Funnel (medium size)

- Safety goggles
- Jackstands (2)
- Drain pan

**Note:** If basic tune-ups are going to be part of routine maintenance, it will be necessary to purchase a good quality stroboscopic timing light and combination tachometer/dwell

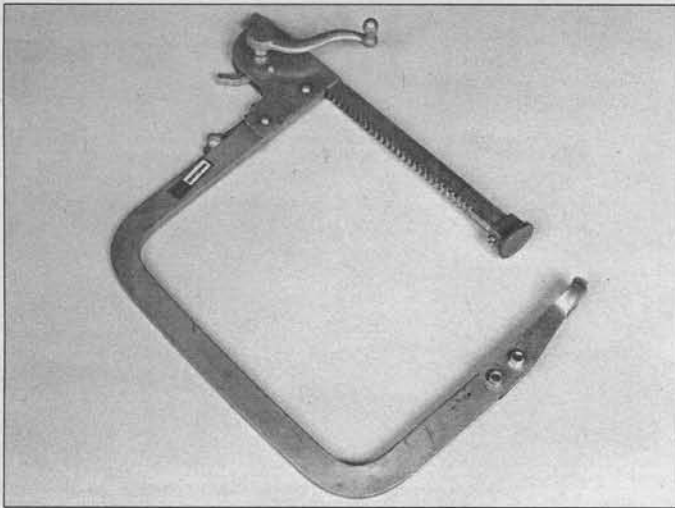

Valve spring compressor

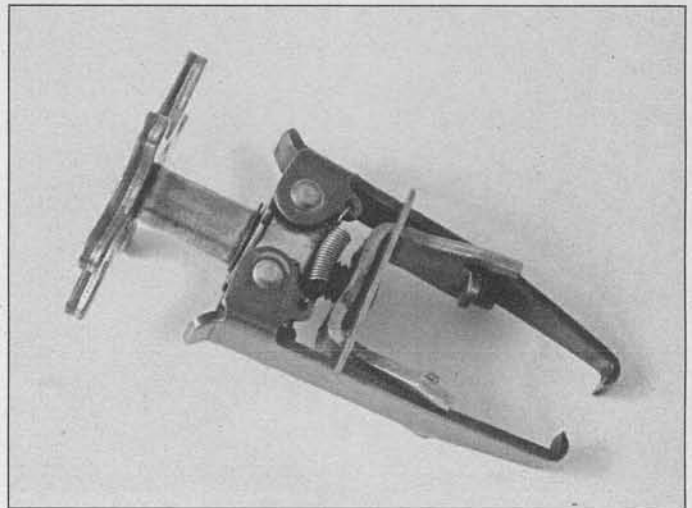

Valve spring compressor

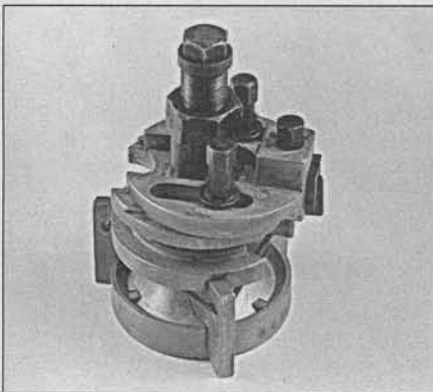

Ridge reamer

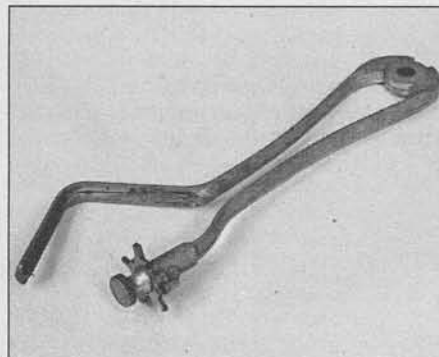

Piston ring groove cleaning tool

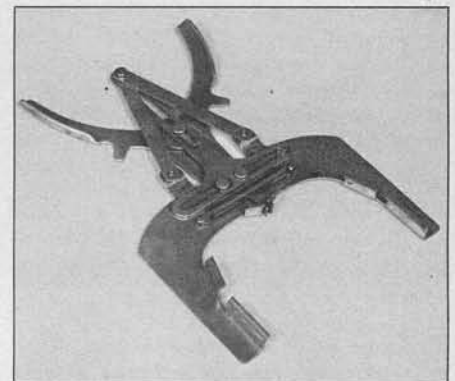

Ring removal/installation tool

meter. Although they are included in the list of special tools, it is mentioned here because they are absolutely necessary for tuning most vehicles properly.

### Repair and overhaul tool set

These tools are essential for anyone who plans to perform major repairs and are in addition to those in the maintenance and minor repair tool kit. Included is a compre-

hensive set of sockets which, though expensive, are invaluable because of their versatility, especially when various extensions and drives are available. We recommend the 1/2-inch drive over the 3/8-inch drive. Although the larger drive is bulky and more expensive, it has the capacity of accepting a very wide range of large sockets. Ideally, however, the mechanic should have a 3/8-inch drive set and a 1/2-inch drive set.

Socket set(s)  
 Reversible ratchet  
 Extension - 10 inch  
 Universal joint  
 Torque wrench (same size drive as sockets)  
 Ball peen hammer - 8 ounce  
 Soft-face hammer (plastic/rubber)  
 Standard screwdriver (1/4-inch x 6 inch)  
 Standard screwdriver (stubby - 5/16-inch)  
 Phillips screwdriver (No. 3 x 8 inch)  
 Phillips screwdriver (stubby - No. 2)  
 Pliers - vise grip  
 Pliers - lineman's  
 Pliers - needle nose  
 Pliers - snap-ring (internal and external)  
 Cold chisel - 1/2-inch  
 Scribe

Scraper (made from flattened copper tubing)  
 Centerpunch  
 Pin punches (1/16, 1/8, 3/16-inch)  
 Steel rule/straightedge - 12 inch  
 Allen wrench set (1/8 to 3/8-inch or 4 mm to 10 mm)  
 A selection of files  
 Wire brush (large)  
 Jackstands (second set)  
 Jack (scissor or hydraulic type)

**Note:** Another tool which is often useful is an electric drill with a chuck capacity of 3/8-inch and a set of good quality drill bits.

### Special tools

The tools in this list include those which are not used regularly, are expensive to buy, or which need to be used in accordance with their manufacturer's instructions. Unless these tools will be used frequently, it is not very economical to purchase many of them. A consideration would be to split the cost and use between yourself and a friend or friends. In addition, most of these tools can be obtained from a tool rental shop on a temporary basis.

This list primarily contains only those tools and instruments widely available to the



Ring compressor

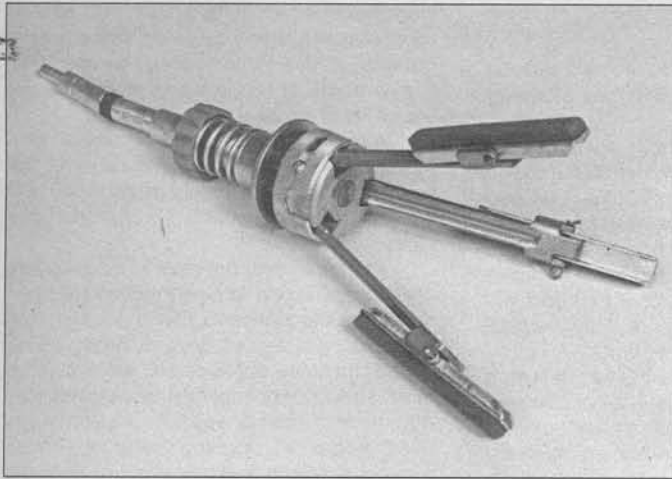

Cylinder hone

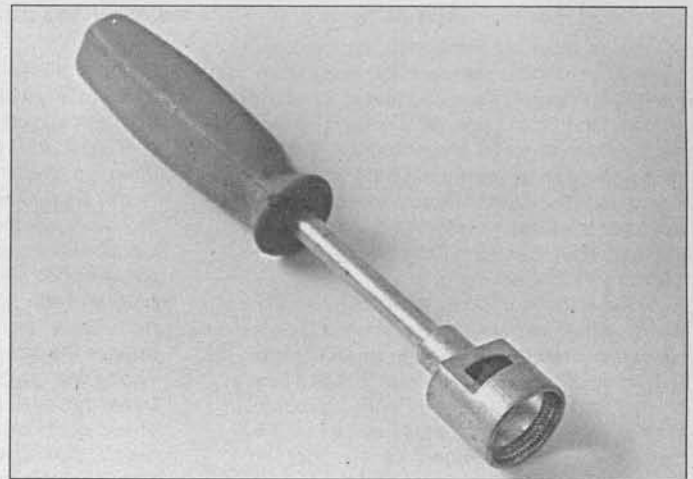

Brake hold-down spring tool

public, and not those special tools produced by the vehicle manufacturer for distribution to dealer service departments. Occasionally, references to the manufacturer's special tools are included in the text of this manual. Generally, an alternative method of doing the job without the special tool is offered. However, sometimes there is no alternative to their use. Where this is the case, and the tool cannot be purchased or borrowed, the work should be turned over to the dealer service department or an automotive repair shop.

- Valve spring compressor*
- Piston ring groove cleaning tool*
- Piston ring compressor*
- Piston ring installation tool*
- Cylinder compression gauge*
- Cylinder ridge reamer*
- Cylinder surfacing hone*
- Cylinder bore gauge*
- Micrometers and/or-dial calipers*
- Hydraulic lifter removal tool*
- Balljoint separator*
- Universal-type puller*
- Impact screwdriver*
- Dial indicator set*
- Stroboscopic timing light (inductive pick-up)*

- Hand operated vacuum/pressure pump*
- Tachometer/dwell meter*
- Universal electrical multimeter*
- Cable hoist*
- Brake spring removal and installation tools*
- Floor jack*

**Buying tools**

For the do-it-yourselfer who is just starting to get involved in vehicle maintenance and repair, there are a number of options available when purchasing tools. If maintenance and minor repair is the extent of the work to be done, the purchase of individual tools is satisfactory. If, on the other hand, extensive work is planned, it would be a good idea to purchase a modest tool set from one of the large retail chain stores. A set can usually be bought at a substantial savings over the individual tool prices, and they often come with a tool box. As additional tools are needed, add-on sets, individual tools and a larger tool box can be purchased to expand the tool selection. Building a tool set gradually allows the cost of the tools to be spread over a longer period of time and gives the mechanic the freedom to choose only those tools that will actually be used.

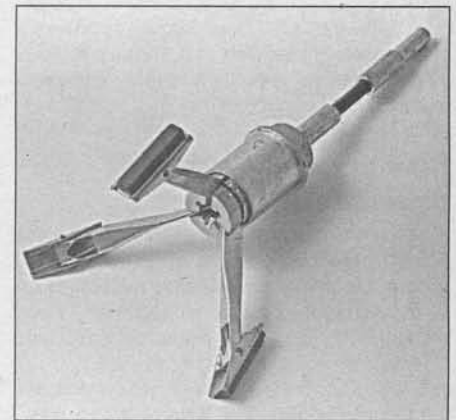

Brake cylinder hone

Tool stores will often be the only source of some of the special tools that are needed, but regardless of where tools are bought, try to avoid cheap ones, especially when buying screwdrivers and sockets, because they won't last very long. The expense involved in replacing cheap tools will eventually be greater than the initial cost of quality tools.

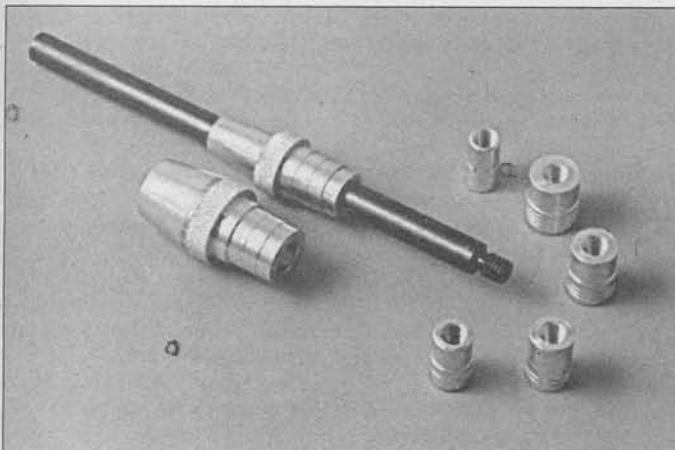

Clutch plate alignment tool

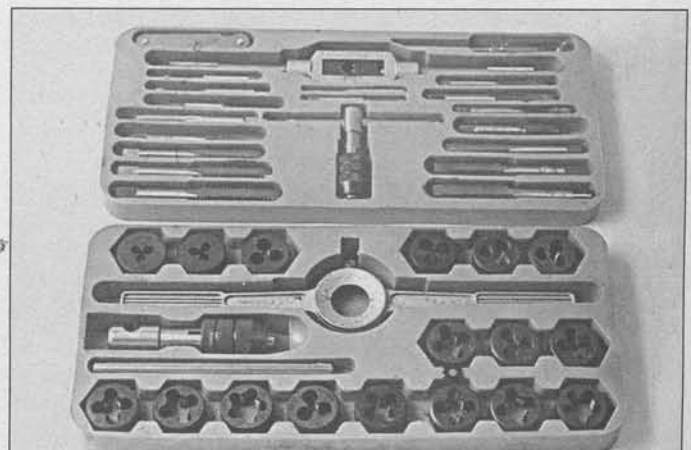

Tap and die set



### Care and maintenance of tools

Good tools are expensive, so it makes sense to treat them with respect. Keep them clean and in usable condition and store them properly when not in use. Always wipe off any dirt, grease or metal chips before putting them away. Never leave tools lying around in the work area. Upon completion of a job, always check closely under the hood for tools that may have been left there so they won't get lost during a test drive.

Some tools, such as screwdrivers, pliers, wrenches and sockets, can be hung on a panel mounted on the garage or workshop wall, while others should be kept in a tool box or tray. Measuring instruments, gauges, meters, etc. must be carefully stored where they cannot be damaged by weather or impact from other tools.

When tools are used with care and stored properly, they will last a very long time. Even with the best of care, though, tools will wear out if used frequently. When a tool is damaged or worn out, replace it. Subsequent jobs will be safer and more enjoyable if you do.

### How to repair damaged threads

Sometimes, the internal threads of a nut or bolt hole can become stripped, usually from overtightening. Stripping threads is an all-too-common occurrence, especially when working with aluminum parts, because aluminum is so soft that it easily strips out.

Usually, external or internal threads are only partially stripped. After they've been cleaned up with a tap or die, they'll still work. Sometimes, however, threads are badly dam-

aged. When this happens, you've got three choices:

- 1) *Drill and tap the hole to the next suitable oversize and install a larger diameter bolt, screw or stud.*
- 2) *Drill and tap the hole to accept a threaded plug, then drill and tap the plug to the original screw size. You can also buy a plug already threaded to the original size. Then you simply drill a hole to the specified size, then run the threaded plug into the hole with a bolt and jam nut. Once the plug is fully seated, remove the jam nut and bolt.*
- 3) *The third method uses a patented thread repair kit like Heli-Coil or Slimsert. These easy-to-use kits are designed to repair damaged threads in straight-through holes and blind holes. Both are available as kits which can handle a variety of sizes and thread patterns. Drill the hole, then tap it with the special included tap. Install the Heli-Coil and the hole is back to its original diameter and thread pitch.*

Regardless of which method you use, be sure to proceed calmly and carefully. A little impatience or carelessness during one of these relatively simple procedures can ruin your whole day's work and cost you a bundle if you wreck an expensive part.

### Working facilities

Not to be overlooked when discussing tools is the workshop. If anything more than routine maintenance is to be carried out, some sort of suitable work area is essential.

It is understood, and appreciated, that many home mechanics do not have a good

workshop or garage available, and end up removing an engine or doing major repairs outside. It is recommended, however, that the overhaul or repair be completed under the cover of a roof.

A clean, flat workbench or table of comfortable working height is an absolute necessity. The workbench should be equipped with a vise that has a jaw opening of at least four inches.

As mentioned previously, some clean, dry storage space is also required for tools, as well as the lubricants, fluids, cleaning solvents, etc. which soon become necessary.

Sometimes waste oil and fluids, drained from the engine or cooling system during normal maintenance or repairs, present a disposal problem. To avoid pouring them on the ground or into a sewage system, pour the used fluids into large containers, seal them with caps and take them to an authorized disposal site or recycling center. Plastic jugs, such as old antifreeze containers, are ideal for this purpose.

Always keep a supply of old newspapers and clean rags available. Old towels are excellent for mopping up spills. Many mechanics use rolls of paper towels for most work because they are readily available and disposable. To help keep the area under the vehicle clean, a large cardboard box can be cut open and flattened to protect the garage or shop floor.

Whenever working over a painted surface, such as when leaning over a fender to service something under the hood, always cover it with an old blanket or bedspread to protect the finish. Vinyl covered pads, made especially for this purpose, are available at auto parts stores.

## Booster battery (jump) starting

Observe the following precautions when using a booster battery to start a vehicle:

- Before connecting the booster battery, make sure the ignition switch is in the Off position.
- Turn off the lights, heater and other electrical loads.
- Your eyes should be shielded. Safety goggles are a good idea.
- Make sure the booster battery is the same voltage as the dead one in the vehicle.
- The two vehicles **MUST NOT TOUCH** each other.
- Make sure the transmission is in Neutral (manual transaxle) or Park (automatic transaxle).
- If the booster battery is not a maintenance-free type, remove the vent caps and lay a cloth over the vent holes.

Connect the red jumper cable to the positive (+) terminals of each battery.

Connect one end of the black cable to the negative (-) terminal of the booster battery. The other end of this cable should be connected to a good ground on the engine block (**see illustration**). Make sure the cable will not come into contact with the fan, drivebelts or other moving parts of the engine.

Start the engine using the booster battery, then, with the engine running at idle speed, disconnect the jumper cables in the reverse order of connection.

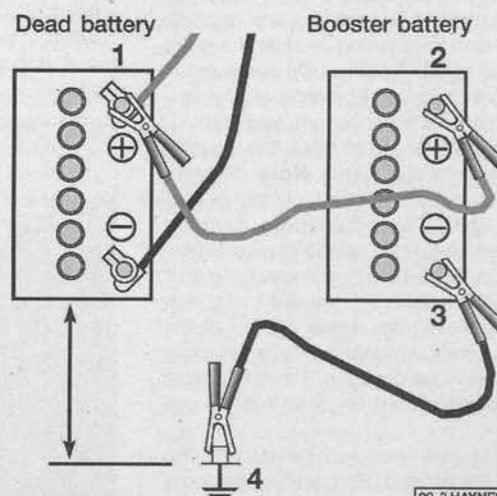

**Make the booster battery cable connections in the numerical order shown (note that the negative cable of the booster battery is NOT attached to the negative terminal of the dead battery)**

00-3 HAYNES

## Jacking and towing

### Jacking

**Warning:** The jack supplied with the vehicle should only be used for changing a tire or placing jackstands under the frame. Never work under the vehicle or start the engine while this jack is being used as the only means of support.

The vehicle should be on level ground. Place the shift lever in Park, if you have an automatic, or Reverse if you have a manual transaxle. Block the wheel diagonally opposite the wheel being changed. Set the parking brake.

Remove the spare tire and jack from stowage. Remove the wheel cover and trim ring (if so equipped) with the tapered end of the lug nut wrench by inserting and twisting the handle and then prying against the back of the wheel cover. **Caution:** On some models the wheel cover can't be removed by prying; the wheel nuts must be removed first.

Loosen, but do not remove, the lug nuts (one-half turn is sufficient). **Note:** Factory alloy wheels may have one locking nut that requires a special keyed adapter (supplied with the vehicle). Next, place the scissors-type jack under the side of the vehicle and adjust the jack height until the slot in the jack head engages with the raised portion of the ridge on the vertical rocker panel flange nearest the wheel to be changed. There is a front and rear jacking point on each side of the vehicle.

Turn the jack handle clockwise until the tire clears the ground. Remove the lug nuts and pull the wheel off. Replace it with the spare.

Install the lug nuts with the beveled edges facing in. Tighten them snugly. Don't

attempt to tighten them completely until the vehicle is lowered or it could slip off the jack. Turn the jack handle counterclockwise to lower the vehicle. Remove the jack and tighten the lug nuts in a criss-cross pattern.

Install the cover (and trim ring, if used) and be sure it's snapped into place all the way around.

Stow the tire, jack and wrench. Unblock the wheels.

### Towing

Vehicles equipped with an automatic transaxle should not be towed with all four wheels on the ground. As a general rule, the vehicle should be towed with the front (drive) wheels off the ground (the best method is to have the vehicle placed on a flat-bed tow truck). If they can't be raised, place them on a dolly.

When towing a vehicle equipped with a manual transaxle with all four wheels on the ground, be sure to place the shift lever in neutral and release the parking brake. The ignition key must be in the ACC position, since the steering lock mechanism isn't strong enough to hold the front wheels straight while towing.

Equipment specifically designed for towing should be used. It should be attached to the main structural members of the vehicle, not the bumpers or brackets.

Safety is a major consideration when towing and all applicable state and local laws must be obeyed. A safety chain system must be used at all times. Remember that power steering and power brakes will not work with the engine off.

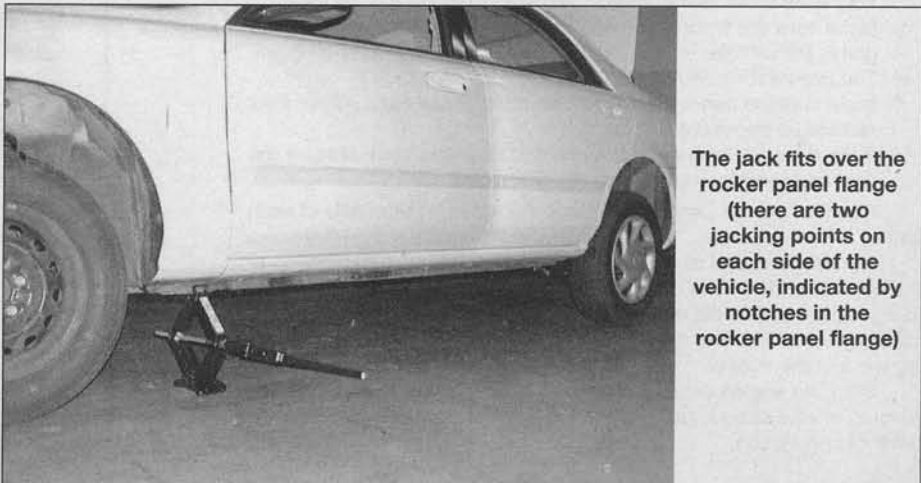

The jack fits over the rocker panel flange (there are two jacking points on each side of the vehicle, indicated by notches in the rocker panel flange)



# Automotive chemicals and lubricants

A number of automotive chemicals and lubricants are available for use during vehicle maintenance and repair. They include a wide variety of products ranging from cleaning solvents and degreasers to lubricants and protective sprays for rubber, plastic and vinyl.

## Cleaners

**Carburetor cleaner and choke cleaner** is a strong solvent for gum, varnish and carbon. Most carburetor cleaners leave a dry-type lubricant film which will not harden or gum up. Because of this film it is not recommended for use on electrical components.

**Brake system cleaner** is used to remove brake dust, grease and brake fluid from the brake system, where clean surfaces are absolutely necessary. It leaves no residue and often eliminates brake squeal caused by contaminants.

**Electrical cleaner** removes oxidation, corrosion and carbon deposits from electrical contacts, restoring full current flow. It can also be used to clean spark plugs, carburetor jets, voltage regulators and other parts where an oil-free surface is desired.

**Demoisturants** remove water and moisture from electrical components such as alternators, voltage regulators, electrical connectors and fuse blocks. They are non-conductive, non-corrosive and non-flammable.

**Degreasers** are heavy-duty solvents used to remove grease from the outside of the engine and from chassis components. They can be sprayed or brushed on and, depending on the type, are rinsed off either with water or solvent.

## Lubricants

**Motor oil** is the lubricant formulated for use in engines. It normally contains a wide variety of additives to prevent corrosion and reduce foaming and wear. Motor oil comes in various weights (viscosity ratings) from 0 to 50. The recommended weight of the oil depends on the season, temperature and the demands on the engine. Light oil is used in cold climates and under light load conditions. Heavy oil is used in hot climates and where high loads are encountered. Multi-viscosity oils are designed to have characteristics of both light and heavy oils and are available in a number of weights from 5W-20 to 20W-50.

**Gear oil** is designed to be used in differentials, manual transmissions and other areas where high-temperature lubrication is required.

**Chassis and wheel bearing grease** is a heavy grease used where increased loads and friction are encountered, such as for wheel bearings, balljoints, tie-rod ends and universal joints.

**High-temperature wheel bearing grease** is designed to withstand the extreme temperatures encountered by wheel bearings

in disc brake equipped vehicles. It usually contains molybdenum disulfide (moly), which is a dry-type lubricant.

**White grease** is a heavy grease for metal-to-metal applications where water is a problem. White grease stays soft under both low and high temperatures (usually from -100 to +190-degrees F), and will not wash off or dilute in the presence of water.

**Assembly lube** is a special extreme pressure lubricant, usually containing moly, used to lubricate high-load parts (such as main and rod bearings and cam lobes) for initial start-up of a new engine. The assembly lube lubricates the parts without being squeezed out or washed away until the engine oiling system begins to function.

**Silicone lubricants** are used to protect rubber, plastic, vinyl and nylon parts.

**Graphite lubricants** are used where oils cannot be used due to contamination problems, such as in locks. The dry graphite will lubricate metal parts while remaining uncontaminated by dirt, water, oil or acids. It is electrically conductive and will not foul electrical contacts in locks such as the ignition switch.

**Moly penetrants** loosen and lubricate frozen, rusted and corroded fasteners and prevent future rusting or freezing.

**Heat-sink grease** is a special electrically non-conductive grease that is used for mounting electronic ignition modules where it is essential that heat is transferred away from the module.

## Sealants

**RTV sealant** is one of the most widely used gasket compounds. Made from silicone, RTV is air curing, it seals, bonds, waterproofs, fills surface irregularities, remains flexible, doesn't shrink, is relatively easy to remove, and is used as a supplementary sealer with almost all low and medium temperature gaskets.

**Anaerobic sealant** is much like RTV in that it can be used either to seal gaskets or to form gaskets by itself. It remains flexible, is solvent resistant and fills surface imperfections. The difference between an anaerobic sealant and an RTV-type sealant is in the curing. RTV cures when exposed to air, while an anaerobic sealant cures only in the absence of air. This means that an anaerobic sealant cures only after the assembly of parts, sealing them together.

**Thread and pipe sealant** is used for sealing hydraulic and pneumatic fittings and vacuum lines. It is usually made from a Teflon compound, and comes in a spray, a paint-on liquid and as a wrap-around tape.

## Chemicals

**Anti-seize compound** prevents seizing,

galling, cold welding, rust and corrosion in fasteners. High-temperature anti-seize, usually made with copper and graphite lubricants, is used for exhaust system and exhaust manifold bolts.

**Anaerobic locking compounds** are used to keep fasteners from vibrating or working loose and cure only after installation, in the absence of air. Medium strength locking compound is used for small nuts, bolts and screws that may be removed later. High-strength locking compound is for large nuts, bolts and studs which aren't removed on a regular basis.

**Oil additives** range from viscosity index improvers to chemical treatments that claim to reduce internal engine friction. It should be noted that most oil manufacturers caution against using additives with their oils.

**Gas additives** perform several functions, depending on their chemical makeup. They usually contain solvents that help dissolve gum and varnish that build up on carburetor, fuel injection and intake parts. They also serve to break down carbon deposits that form on the inside surfaces of the combustion chambers. Some additives contain upper cylinder lubricants for valves and piston rings, and others contain chemicals to remove condensation from the gas tank.

## Miscellaneous

**Brake fluid** is specially formulated hydraulic fluid that can withstand the heat and pressure encountered in brake systems. Care must be taken so this fluid does not come in contact with painted surfaces or plastics. An opened container should always be resealed to prevent contamination by water or dirt.

**Weatherstrip adhesive** is used to bond weatherstripping around doors, windows and trunk lids. It is sometimes used to attach trim pieces.

**Undercoating** is a petroleum-based, tar-like substance that is designed to protect metal surfaces on the underside of the vehicle from corrosion. It also acts as a sound-deadening agent by insulating the bottom of the vehicle.

**Waxes and polishes** are used to help protect painted and plated surfaces from the weather. Different types of paint may require the use of different types of wax and polish. Some polishes utilize a chemical or abrasive cleaner to help remove the top layer of oxidized (dull) paint on older vehicles. In recent years many non-wax polishes that contain a wide variety of chemicals such as polymers and silicones have been introduced. These non-wax polishes are usually easier to apply and last longer than conventional waxes and polishes.

# Conversion factors

## Length (distance)

Inches (in)	X 25.4 = Millimeters (mm)	X 0.0394 = Inches (in)
Feet (ft)	X 0.305 = Meters (m)	X 3.281 = Feet (ft)
Miles	X 1.609 = Kilometers (km)	X 0.621 = Miles

## Volume (capacity)

Cubic inches (cu in; in <sup>3</sup> )	X 16.387 = Cubic centimeters (cc; cm <sup>3</sup> )	X 0.061 = Cubic inches (cu in; in <sup>3</sup> )
Imperial pints (Imp pt)	X 0.568 = Liters (l)	X 1.76 = Imperial pints (Imp pt)
Imperial quarts (Imp qt)	X 1.137 = Liters (l)	X 0.88 = Imperial quarts (Imp qt)
Imperial quarts (Imp qt)	X 1.201 = US quarts (US qt)	X 0.833 = Imperial quarts (Imp qt)
US quarts (US qt)	X 0.946 = Liters (l)	X 1.057 = US quarts (US qt)
Imperial gallons (Imp gal)	X 4.546 = Liters (l)	X 0.22 = Imperial gallons (Imp gal)
Imperial gallons (Imp gal)	X 1.201 = US gallons (US gal)	X 0.833 = Imperial gallons (Imp gal)
US gallons (US gal)	X 3.785 = Liters (l)	X 0.264 = US gallons (US gal)

## Mass (weight)

Ounces (oz)	X 28.35 = Grams (g)	X 0.035 = Ounces (oz)
Pounds (lb)	X 0.454 = Kilograms (kg)	X 2.205 = Pounds (lb)

## Force

Ounces-force (ozf; oz)	X 0.278 = Newtons (N)	X 3.6 = Ounces-force (ozf; oz)
Pounds-force (lbf; lb)	X 4.448 = Newtons (N)	X 0.225 = Pounds-force (lbf; lb)
Newtons (N)	X 0.1 = Kilograms-force (kgf; kg)	X 9.81 = Newtons (N)

## Pressure

Pounds-force per square inch (psi; lbf/in <sup>2</sup> ; lb/in <sup>2</sup> )	X 0.070 = Kilograms-force per square centimeter (kgf/cm <sup>2</sup> ; kg/cm <sup>2</sup> )	X 14.223 = Pounds-force per square inch (psi; lbf/in <sup>2</sup> ; lb/in <sup>2</sup> )
Pounds-force per square inch (psi; lbf/in <sup>2</sup> ; lb/in <sup>2</sup> )	X 0.068 = Atmospheres (atm)	X 14.696 = Pounds-force per square inch (psi; lbf/in <sup>2</sup> ; lb/in <sup>2</sup> )
Pounds-force per square inch (psi; lbf/in <sup>2</sup> ; lb/in <sup>2</sup> )	X 0.069 = Bars	X 14.5 = Pounds-force per square inch (psi; lbf/in <sup>2</sup> ; lb/in <sup>2</sup> )
Pounds-force per square inch (psi; lbf/in <sup>2</sup> ; lb/in <sup>2</sup> )	X 6.895 = Kilopascals (kPa)	X 0.145 = Pounds-force per square inch (psi; lbf/in <sup>2</sup> ; lb/in <sup>2</sup> )
Kilopascals (kPa)	X 0.01 = Kilograms-force per square centimeter (kgf/cm <sup>2</sup> ; kg/cm <sup>2</sup> )	X 98.1 = Kilopascals (kPa)

## Torque (moment of force)

Pounds-force inches (lbf in; lb in)	X 1.152 = Kilograms-force centimeter (kgf cm; kg cm)	X 0.868 = Pounds-force inches (lbf in; lb in)
Pounds-force inches (lbf in; lb in)	X 0.113 = Newton meters (Nm)	X 8.85 = Pounds-force inches (lbf in; lb in)
Pounds-force inches (lbf in; lb in)	X 0.083 = Pounds-force feet (lbf ft; lb ft)	X 12 = Pounds-force inches (lbf in; lb in)
Pounds-force feet (lbf ft; lb ft)	X 0.138 = Kilograms-force meters (kgf m; kg m)	X 7.233 = Pounds-force feet (lbf ft; lb ft)
Pounds-force feet (lbf ft; lb ft)	X 1.356 = Newton meters (Nm)	X 0.738 = Pounds-force feet (lbf ft; lb ft)
Newton meters (Nm)	X 0.102 = Kilograms-force meters (kgf m; kg m)	X 9.804 = Newton meters (Nm)

## Vacuum

Inches mercury (in. Hg)	X 3.377 = Kilopascals (kPa)	X 0.2961 = Inches mercury
Inches mercury (in. Hg)	X 25.4 = Millimeters mercury (mm Hg)	X 0.0394 = Inches mercury

## Power

Horsepower (hp)	X 745.7 = Watts (W)	X 0.0013 = Horsepower (hp)
-----------------	---------------------	----------------------------

## Velocity (speed)

Miles per hour (miles/hr; mph)	X 1.609 = Kilometers per hour (km/hr; kph)	X 0.621 = Miles per hour (miles/hr; mph)
--------------------------------	--	--

## Fuel consumption\*

Miles per gallon, Imperial (mpg)	X 0.354 = Kilometers per liter (km/l)	X 2.825 = Miles per gallon, Imperial (mpg)
Miles per gallon, US (mpg)	X 0.425 = Kilometers per liter (km/l)	X 2.352 = Miles per gallon, US (mpg)

## Temperature

Degrees Fahrenheit = (°C x 1.8) + 32	Degrees Celsius (Degrees Centigrade; °C) = (°F - 32) x 0.56
--------------------------------------	---

\*It is common practice to convert from miles per gallon (mpg) to liters/100 kilometers (l/100km), where mpg (Imperial) x l/100 km = 282 and mpg (US) x l/100 km = 235



**DECIMALS to MILLIMETERS**

Decimal	mm	Decimal	mm
0.001	0.0254	0.500	12.7000
0.002	0.0508	0.510	12.9540
0.003	0.0762	0.520	13.2080
0.004	0.1016	0.530	13.4620
0.005	0.1270	0.540	13.7160
0.006	0.1524	0.550	13.9700
0.007	0.1778	0.560	14.2240
0.008	0.2032	0.570	14.4780
0.009	0.2286	0.580	14.7320
		0.590	14.9860
0.010	0.2540		
0.020	0.5080		
0.030	0.7620		
0.040	1.0160	0.600	15.2400
0.050	1.2700	0.610	15.4940
0.060	1.5240	0.620	15.7480
0.070	1.7780	0.630	16.0020
0.080	2.0320	0.640	16.2560
0.090	2.2860	0.650	16.5100
		0.660	16.7640
0.100	2.5400	0.670	17.0180
0.110	2.7940	0.680	17.2720
0.120	3.0480	0.690	17.5260
0.130	3.3020		
0.140	3.5560		
0.150	3.8100		
0.160	4.0640	0.700	17.7800
0.170	4.3180	0.710	18.0340
0.180	4.5720	0.720	18.2880
0.190	4.8260	0.730	18.5420
		0.740	18.7960
0.200	5.0800	0.750	19.0500
0.210	5.3340	0.760	19.3040
0.220	5.5880	0.770	19.5580
0.230	5.8420	0.780	19.8120
0.240	6.0960	0.790	20.0660
0.250	6.3500		
0.260	6.6040		
0.270	6.8580	0.800	20.3200
0.280	7.1120	0.810	20.5740
0.290	7.3660	0.820	21.8280
		0.830	21.0820
0.300	7.6200	0.840	21.3360
0.310	7.8740	0.850	21.5900
0.320	8.1280	0.860	21.8440
0.330	8.3820	0.870	22.0980
0.340	8.6360	0.880	22.3520
0.350	8.8900	0.890	22.6060
0.360	9.1440		
0.370	9.3980		
0.380	9.6520		
0.390	9.9060		
		0.900	22.8600
0.400	10.1600	0.910	23.1140
0.410	10.4140	0.920	23.3680
0.420	10.6680	0.930	23.6220
0.430	10.9220	0.940	23.8760
0.440	11.1760	0.950	24.1300
0.450	11.4300	0.960	24.3840
0.460	11.6840	0.970	24.6380
0.470	11.9380	0.980	24.8920
0.480	12.1920	0.990	25.1460
0.490	12.4460	1.000	25.4000

**FRACTIONS to DECIMALS to MILLIMETERS**

Fraction	Decimal	mm	Fraction	Decimal	mm
1/64	0.0156	0.3969	33/64	0.5156	13.0969
1/32	0.0312	0.7938	17/32	0.5312	13.4938
3/64	0.0469	1.1906	35/64	0.5469	13.8906
1/16	0.0625	1.5875	9/16	0.5625	14.2875
5/64	0.0781	1.9844	37/64	0.5781	14.6844
3/32	0.0938	2.3812	19/32	0.5938	15.0812
7/64	0.1094	2.7781	39/64	0.6094	15.4781
1/8	0.1250	3.1750	5/8	0.6250	15.8750
9/64	0.1406	3.5719	41/64	0.6406	16.2719
5/32	0.1562	3.9688	21/32	0.6562	16.6688
11/64	0.1719	4.3656	43/64	0.6719	17.0656
3/16	0.1875	4.7625	11/16	0.6875	17.4625
13/64	0.2031	5.1594	45/64	0.7031	17.8594
7/32	0.2188	5.5562	23/32	0.7188	18.2562
15/64	0.2344	5.9531	47/64	0.7344	18.6531
1/4	0.2500	6.3500	3/4	0.7500	19.0500
17/64	0.2656	6.7469	49/64	0.7656	19.4469
9/32	0.2812	7.1438	25/32	0.7812	19.8438
19/64	0.2969	7.5406	51/64	0.7969	20.2406
5/16	0.3125	7.9375	13/16	0.8125	20.6375
21/64	0.3281	8.3344	53/64	0.8281	21.0344
11/32	0.3438	8.7312	27/32	0.8438	21.4312
23/64	0.3594	9.1281	55/64	0.8594	21.8281
3/8	0.3750	9.5250	7/8	0.8750	22.2250
25/64	0.3906	9.9219	57/64	0.8906	22.6219
13/32	0.4062	10.3188	29/32	0.9062	23.0188
27/64	0.4219	10.7156	59/64	0.9219	23.4156
7/16	0.4375	11.1125	15/16	0.9375	23.8125
29/64	0.4531	11.5094	61/64	0.9531	24.2094
15/32	0.4688	11.9062	31/32	0.9688	24.6062
31/64	0.4844	12.3031	63/64	0.9844	25.0031
1/2	0.5000	12.7000	1	1.0000	25.4000