

INTRODUCTION

How to Use This Manual

This manual is divided into 14 sections. The first page of each section is marked with a black tab that lines up with one of the thumb index tabs on the front and back covers. You can quickly find the first page of each section without looking through a full table of contents. The symbols printed at the top corner of each page can also be used as a quick reference system.

Each section includes:

1. A table of contents, or an exploded view index showing:
 - Parts disassembly sequence.
 - Bolt torques and thread sizes:
 - Page references to descriptions in text.
2. Disassembly/assembly procedures and tools.
3. Inspection.
4. Testing/troubleshooting.
5. Repair.
6. Adjustments.

Special Information

WARNING Indicates a strong possibility of severe personal injury or loss of life if instructions are not followed.

CAUTION: Indicates a possibility of personal injury or equipment damage if instructions are not followed.

NOTE: Gives helpful information.

CAUTION: Detailed descriptions of *standard* workshop procedures, safety principles and service operations are not included. Please note that this manual does contain warnings and cautions against some specific service methods which could cause **PERSONAL INJURY**, or could damage a vehicle or make it unsafe. Please understand that these warnings cannot cover all conceivable ways in which service, whether or not recommended by Honda motor, might be done, or of the possible hazardous consequences of each conceivable way, nor could Honda motor investigate all such ways. Anyone using service procedures or tools, whether or not recommended by Honda motor, *must satisfy himself thoroughly* that neither personal safety nor vehicle safety will be jeopardized.

All information contained in this manual is based on the latest product information available at the time of printing. We reserve the right to make changes at any time without notice. No part of this publication may be reproduced, stored in retrieval system, or transmitted, in any form by any means, electronic, mechanical, photocopying, recording, or otherwise, without the prior written permission of the publisher. This includes text, figures and tables.

First Edition 10/85
Third Print 11/89 896 pages
All Rights Reserved

HONDA MOTOR CO., LTD.
Service Publication Office

General Info



Special Tools



Specifications

specs

Maintenance



Engine



Cooling



Fuel and
Emission Controls



Transaxle



Steering



Suspension



Brakes



Body



Heater and
Air Conditioner



Electrical





General Information

Chassis and Engine Codes	1-2
Identification Number Locations	1-3
Label Locations	1-4
Lift and Support Points	1-5
Towing	1-8
Preparation of Work	1-9

Chassis and Engine Codes

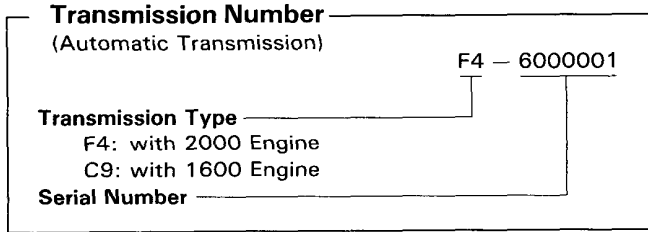
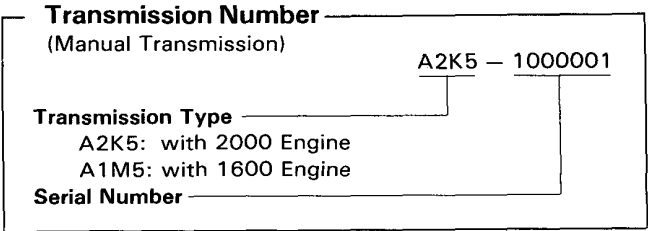
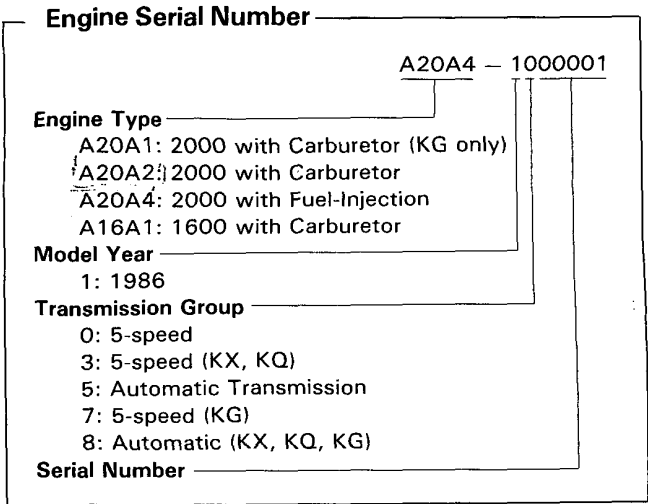
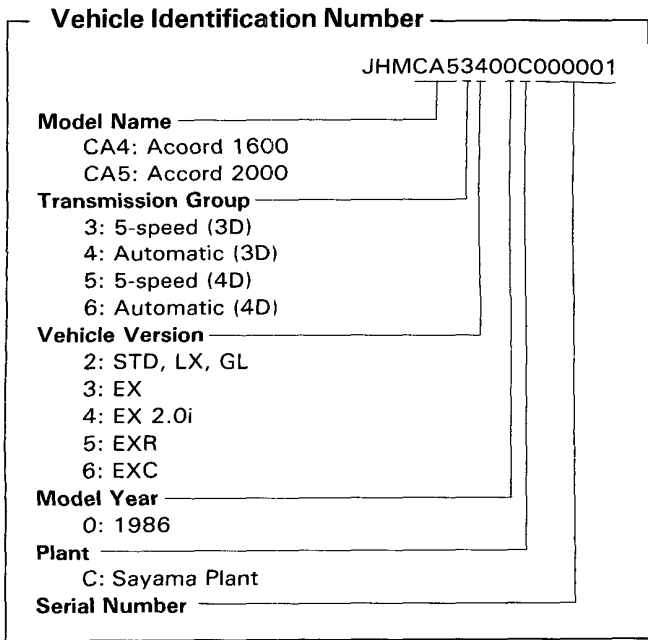

Identification Number Locations

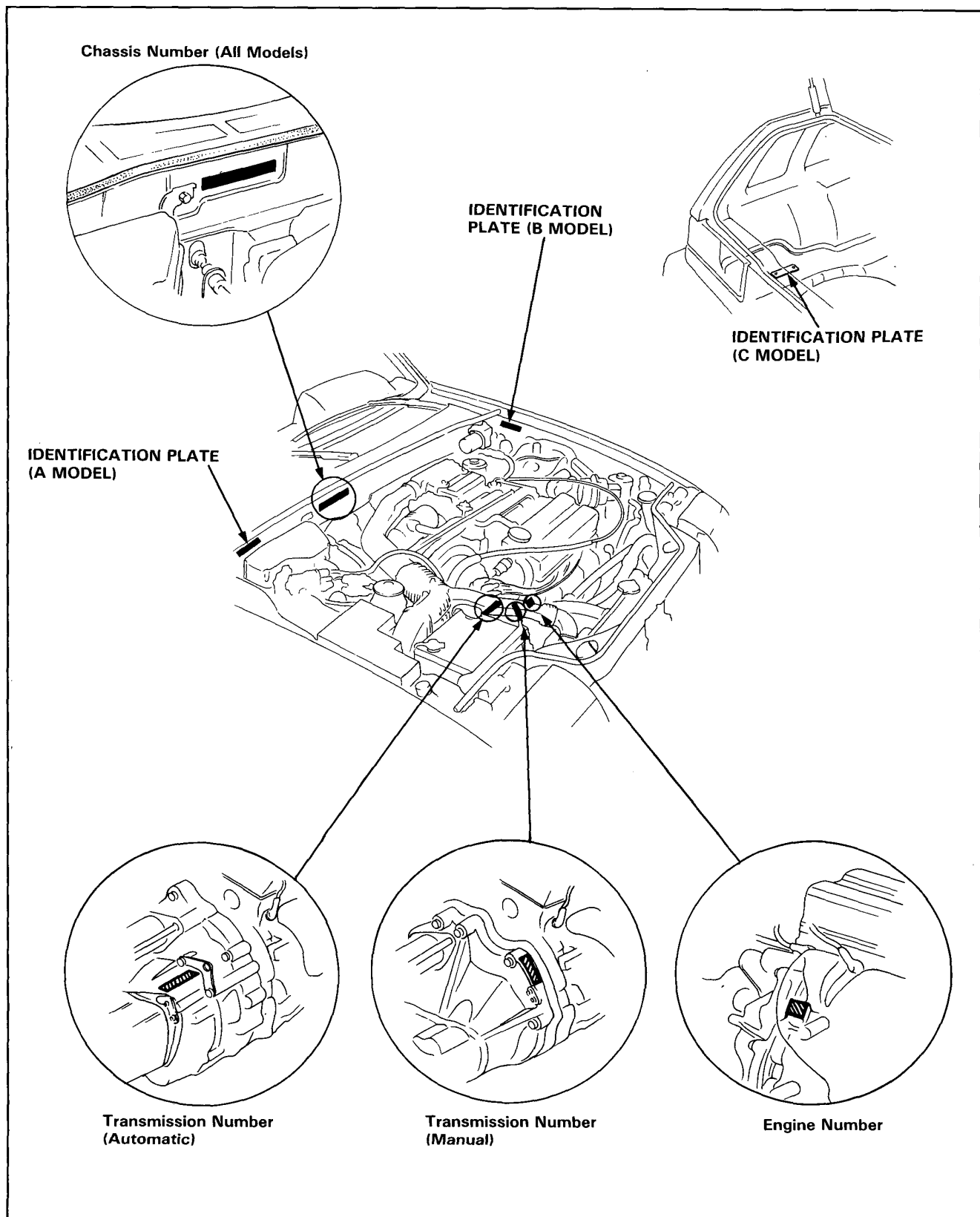

Label Locations

A20A4 Engine (KS Model) shown; Other Engine similar

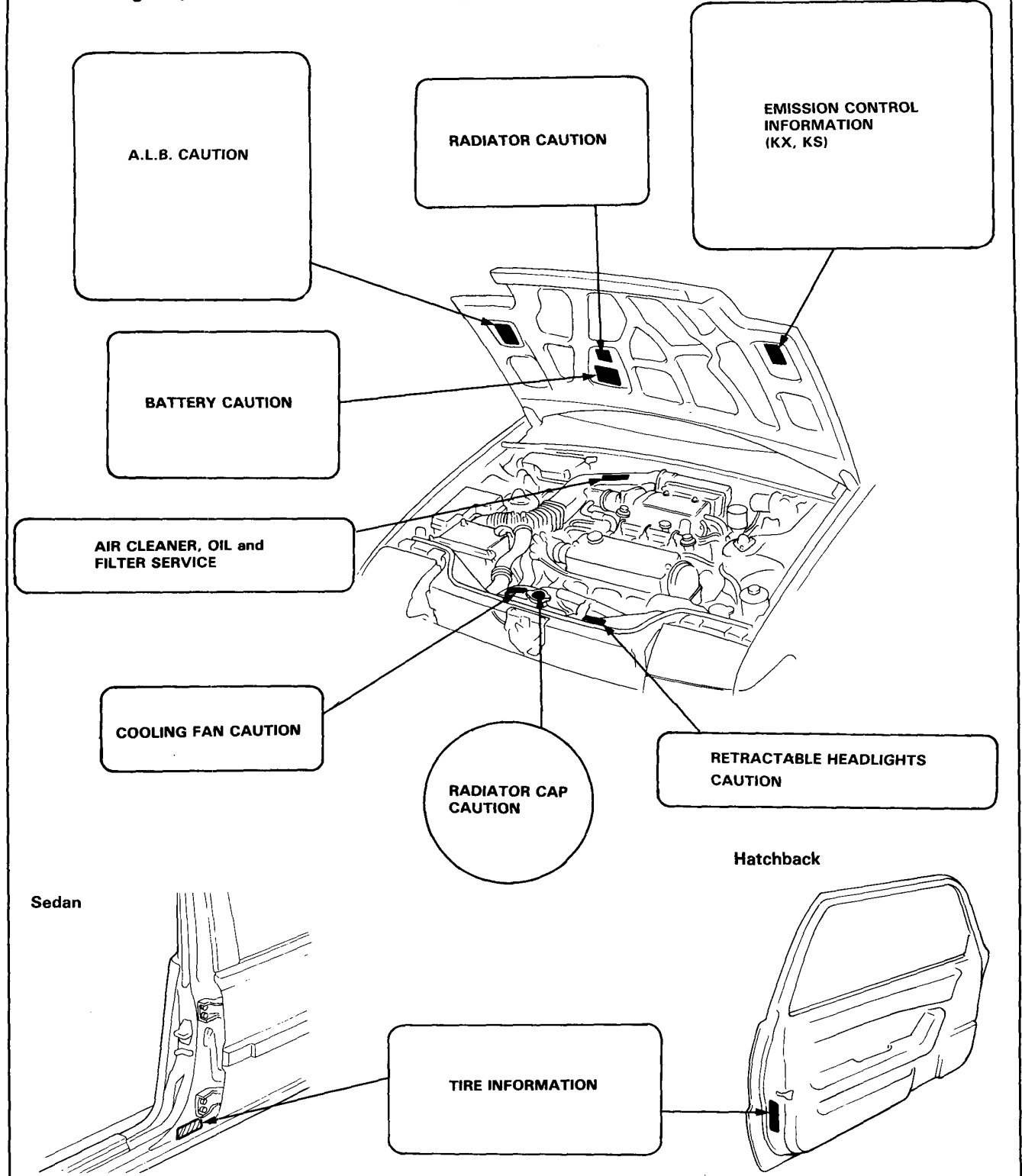



Lift and Support Points

Hoist

1. Place the lift blocks as shown.
2. Raise the hoist a few inches and rock the car to be sure it is firmly supported.
3. Raise the hoist to full height and inspect lift points for solid support.

WARNING When heavy rear components such as suspension, fuel tank, spare tire and trunk lid/hatch are to be removed, place additional weight in the trunk before hoisting. When substantial weight is removed from the rear of the car, the center of gravity may change and can cause the car to tip forward on the hoist.

NOTE: Since each tire/wheel assembly weights approximately 14 kg (30 lbs), placing the front wheels in the truck can assist with the weight transfer.

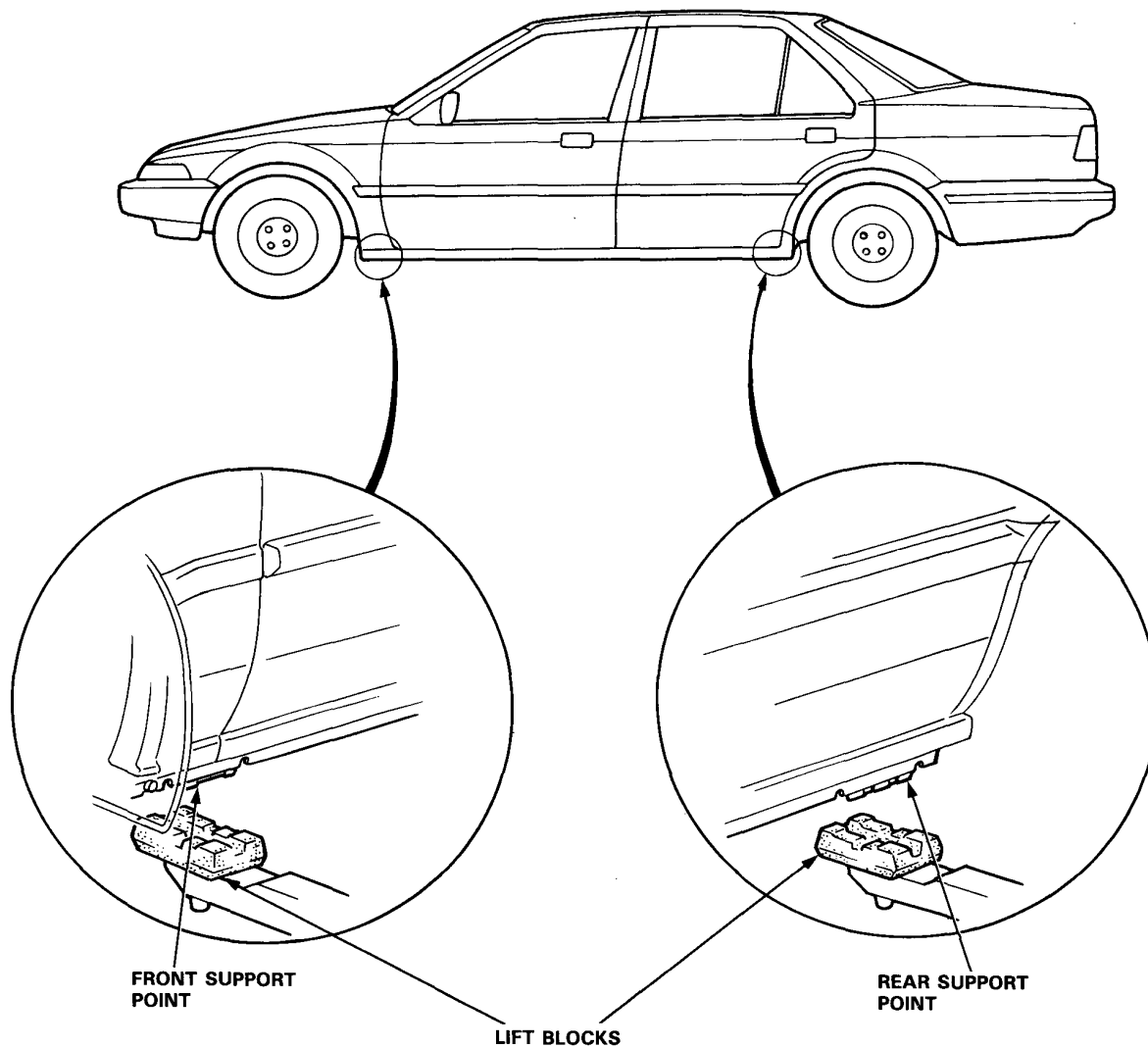

(cont'd)

Lift and Support Points (cont'd)

Floor Jack

1. Set the parking brake and block the wheels that are not being lifted.
2. When lifting the rear of car, put the gear shift lever in reverse (Automatic in PARK).
3. Raise the car high enough to insert the safety stands.
4. Adjust and place the safety stands as shown on page 1-8 so the car will be approximately level, then lower car onto them.

WARNING

- Always use safety stands when working on or under any vehicle that is supported by only a jack.
- Never attempt to use a bumper jack for lifting or supporting the car.

Front

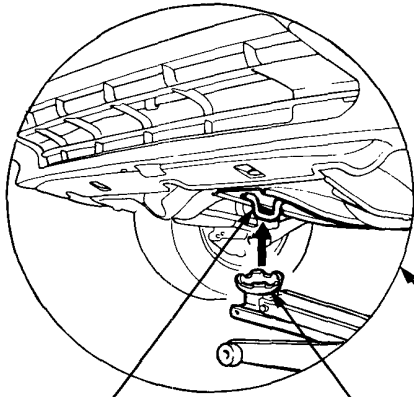

Center the jacking bracket in the middle of jack lift platform.

LIFT PLATFORM

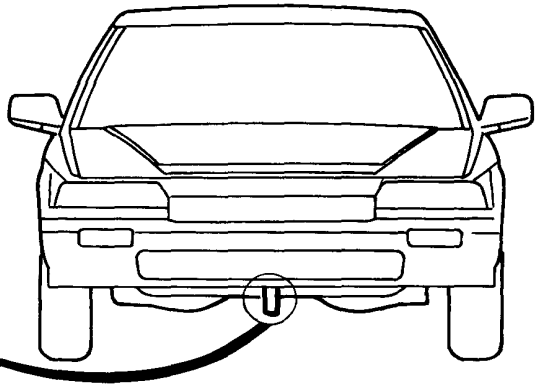

Rear

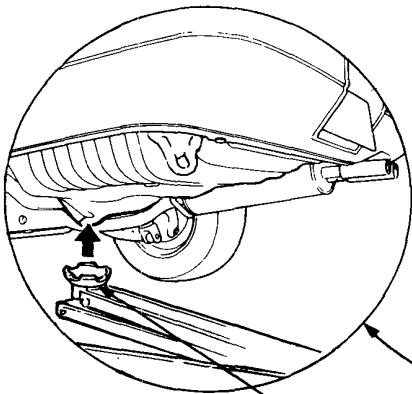

Center the jacking bracket in the middle of jack lift platform.

LIFT PLATFORM

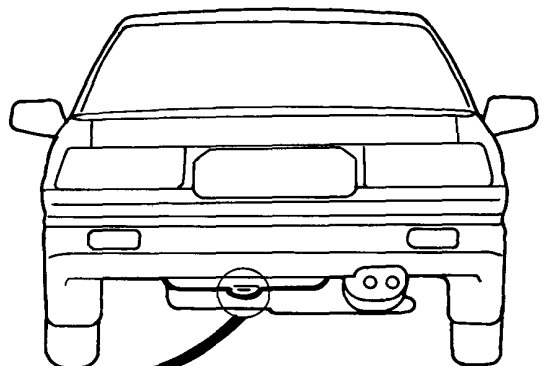



Safety Stands

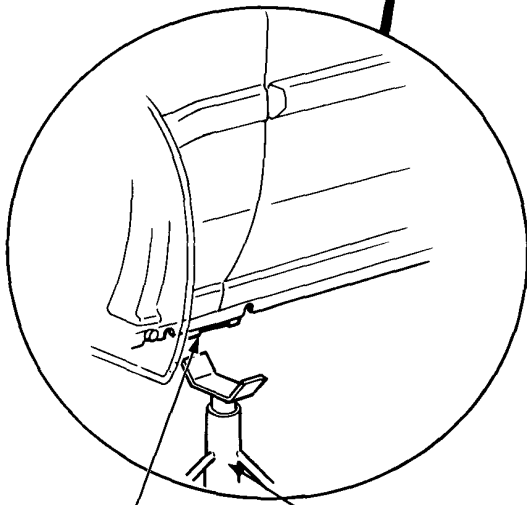
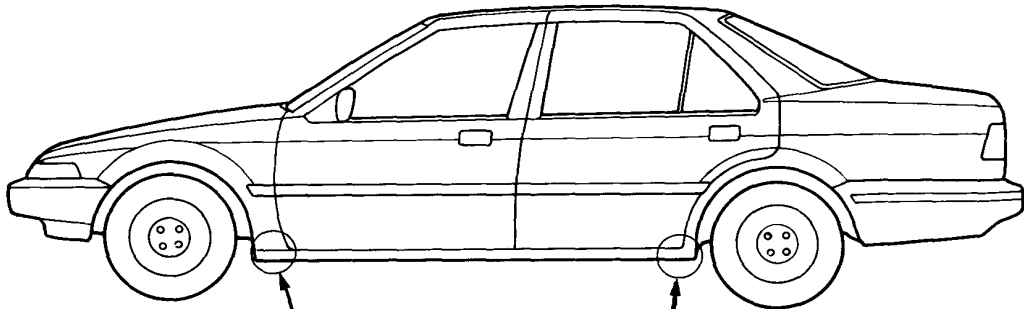

FRONT SUPPORT POINT

SAFETY STAND

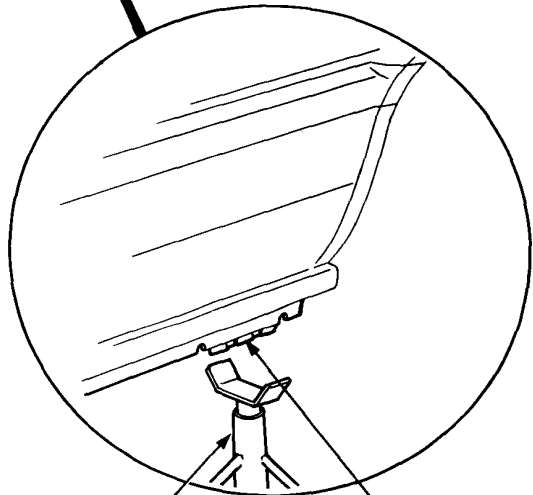

SAFETY STAND

REAR SUPPORT POINT

Towing

Towing

If possible, always tow the car with the front wheels off the ground. Do not use the bumpers to lift the car or to support the car's weight while towing. Check local regulations for towing with a chain or frame-mounted tow bar. A chain may be attached to the hook shown in the illustration. Do to attach a tow bar to either bumper.

If the car is to be towed with four wheels on the ground, observe the following precautions:

1. Wheels and axle must not be touching body or frame.
2. Turn the ignition key to the "I" position and make sure the steering wheel turns freely.
3. Place the transmission in NEUTRAL.
4. Release the parking brake.
5. DO NOT exceed 55KPH (35 MPH) for distances of more than 80 km (50 miles).

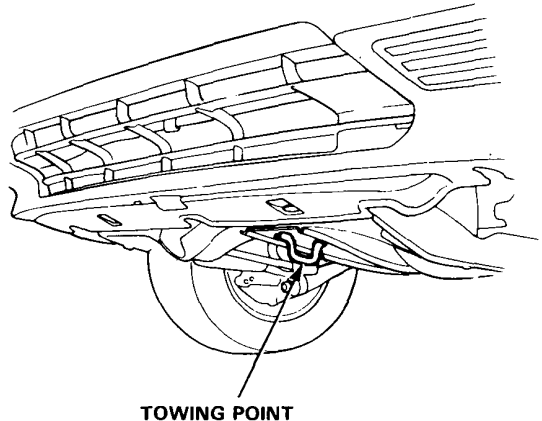

Preparation of Work



Special Caution Items For This Car

1. Retractable headlights are installed. For manual raising and lowering, the fuse must be pulled. When raising and lowering is executed without pulling the fuse, danger may be caused by rapid turning of the manual retracting knob.

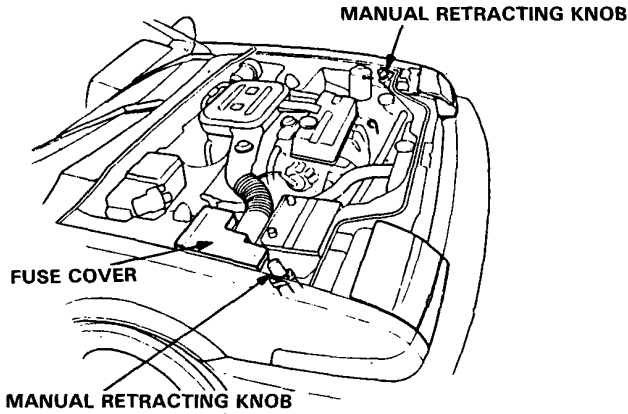

2. For cars equipped with A.L.B., the high-pressure brake fluid must be drained before disassembly of the A.L.B. piping system. When this is not done, danger may be caused by brake fluid squirting out under high pressure. For draining of the high-pressure brake fluid, refer to Section 20.

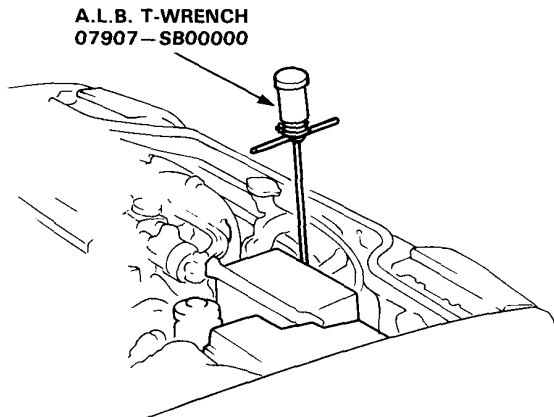

3. Fuel Line Servicing (A20A4 Engine)
 - Relieve fuel pressure by loosening the service bolt provided on the top of the fuel filter before disconnecting a fuel hose or a fuel pipe.

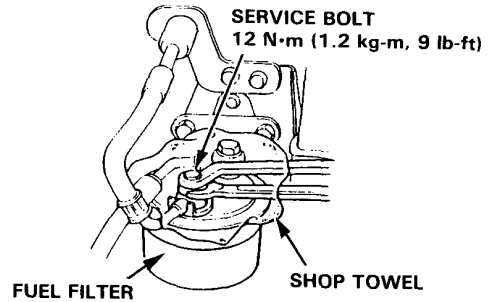

- Be sure to replace washers, O-rings, and seal rubbers with new ones when servicing fuel line parts.
- Always apply oil to the surfaces of O-rings and seal rings before installation. Never use brake fluid, radiator fluid, vegetable oils or alcohol-based oils.

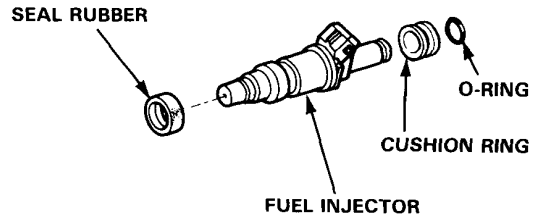

- When assembling the flare joint of the high-pressure fuel line, clean the joint and coat with new engine oil.
- When installing an injector, check the angle of the coupler. The center line of the coupler should align with the setting mark on the injector holder.

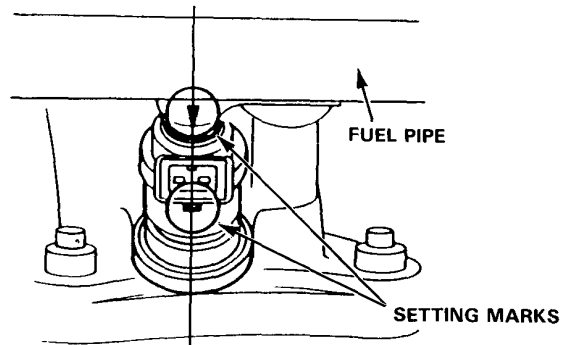

(cont'd)

Preparation of Work

Special Caution Items For This Car (cont'd)

4. Inspection for fuel leakage
 - After assembling fuel line parts, turn ON the ignition switch (do not operate the starter) so that the fuel pump is operated for approximately two seconds and the fuel is pressurized. Repeat this operation two or three times and check whether any fuel leakage has occurred in any of the various points in the fuel line.
5. Installation of an amateur radio for cars equipped with PGM-FI and A.L.B.

Care has been taken for the PGM-FI and A.L.B. control units (computer) and its wiring to prevent erroneous operation from external interference, but erroneous operation of the computer may be caused by entry of extremely strong radio waves. Attention must be paid to the following items to prevent erroneous operation of the computer.

 - The antenna and the body of the radio must be at least 200 mm (7.9 in.) away from the computer. (The computer installation position is under the right side seat.)
 - Do not lead the antenna feeder and the coaxial cable over a long distance parallel to the wiring, and when crossing with the wiring is required, execute crossing at a right angle.
 - Do not install a radio with a large output (max. 10 W).
6. Apply liquid gasket to the transmission, oil pump cover, right side cover and water outlet. Use HONDA PARTS NO 08740-99986 as a liquid gasket.
 - Check that the mating surfaces are clean and dry before applying liquid gasket. Degrease the mating surfaces if necessary.
 - Apply liquid gasket evenly, being careful to cover all the mating surface.
 - To prevent leakage of oil, apply liquid gasket to the inner threads of the bolt holes.
 - Do not allow liquid gasket to stand for more than 20 minutes before assembly.
 - Fill the case with clean engine oil or coolant 30 minutes after assembly.

CAUTION: Observe all safety precautions and notes while working.

1. Protect all painted surfaces and seats against dirt and scratches with a clean cloth or vinyl cover.

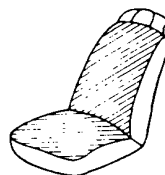

2. Work safely and give your work your undivided attention. When either the front or rear wheels are to be raised, block the remaining wheels securely. Exchange signals as frequently as possible when a work involves two or more workers. Do not run the engine unless the shop or working area is well ventilated.

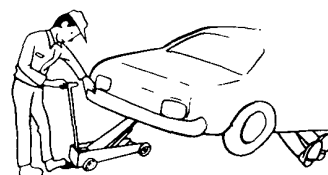

3. Prior to removing or disassembling parts, they must be inspected carefully to isolate the cause for which the service is called for. Observe all safety notes and precautions and follow the proper procedures as described in this manual.



Mark or place all removed parts in order in a parts rack so they can be placed back to their original places or parts from which they were removed or with which they were mated.

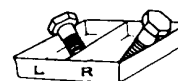



4. Use special tool when use of such a tool is specified.

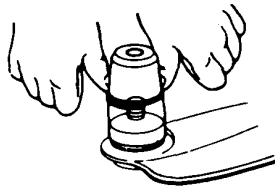

5. Parts must be assembled with the proper looseness or tightness according to the maintenance standards established.
6. When tightening bolts or nuts, begin on center or large diameter bolts and tighten them in crisscross pattern in two or more steps if necessary.

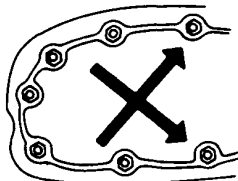

7. Use new packings, gaskets, O-rings and cotter pins whenever reassembling.

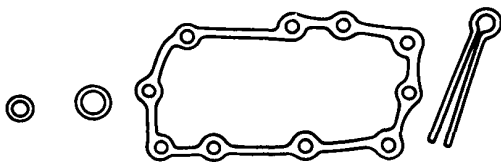

8. Use genuine HONDA parts and lubricants or those equivalent. When parts are to be reused, they must be inspected carefully to make sure they are not damaged or deteriorated and in good usable condition.

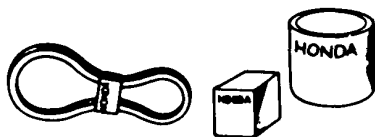

9. Coat or fill parts with specified grease where specified grease where specified (page 4-2). Clean all removed parts in or with solvent upon disassembly.

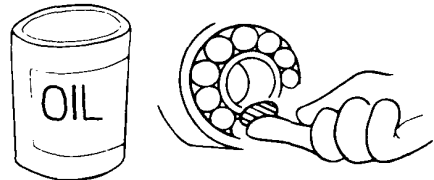

10. Brake fluid and hydraulic components

- When replenishing the system, use extreme care not to allow dust and dirt from entering the inside.
- Do not mix different brands of fluid as they may not be compatible.
- Do not reuse drained brake fluid.
- Brake fluid can cause damage to the painted surfaces. Wipe up spilled fluid at once.
- After disconnecting brake hoses or pipes from the joint, be sure plug the opening to prevent loss of brake fluid.
- Clean all disassembled parts only in clean BRAKE FLUID. Blow open all holes and passages with compressed air.



- Keep disassembled parts from air-borne dust and abrasives.
- Check that parts are clean before assembly.

11. Avoid oil or grease getting on rubber parts and tubes.

12. Upon assembling, check every possible part for proper installation and movement or operation.

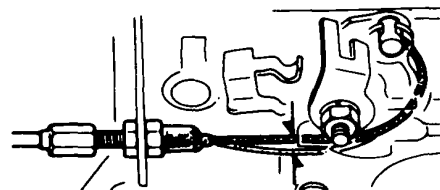

Preparation of Work

Electrical

- Before making any repairs on electric wires or parts, disconnect the battery cables from the battery starting with the negative (-) terminal.

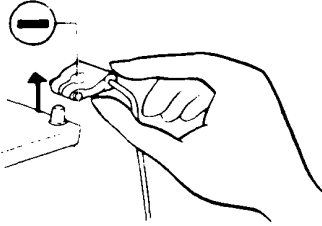

- After making repairs, check each wire or part for proper routing and installation. Also check to see that they are connected properly.
- Always connect the battery positive (+) cable first, then connect the negative (-) cable.

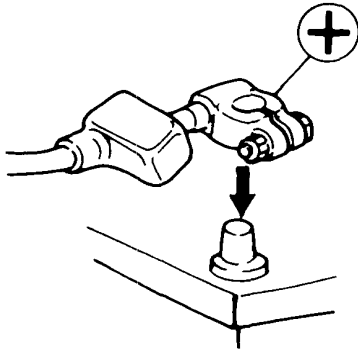

- Coat the terminals with clean grease after connecting the battery cables.
- Don't forget to install the terminal cover over the positive battery terminal after connecting.
- Before installing a new fuse, isolate the cause and take corrective measures, particularly when frequent fuse failure occurs.

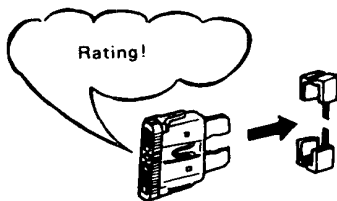

- Be sure to install the terminal cover over the connections after a wire or wire harness has been connected.

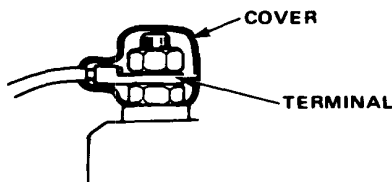

- When removing locking couplers, be sure to disconnect the lock before performing work.
- Couplers may be of two types, those in which the lock is pressed to remove, and those in which the lock is pulled up to remove. Be sure to ascertain the type of locking device before beginning work. The following is a depiction of the means of disconnecting various typical couplers.

Press to disengage:

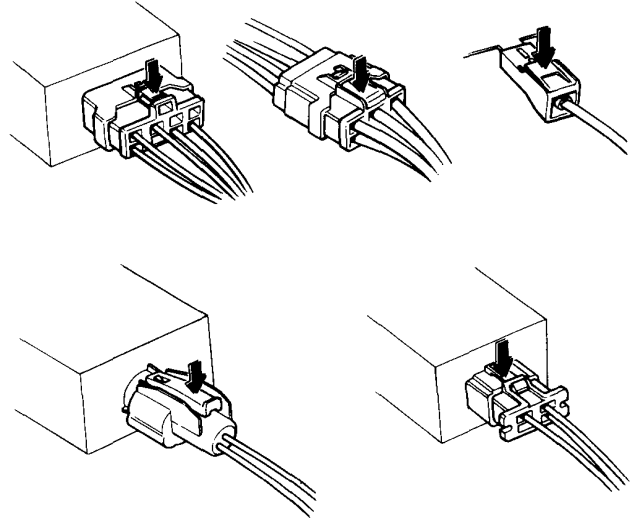

Pull up to disengage:

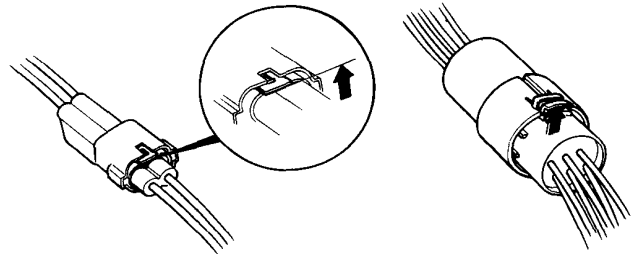

- When disconnecting locks, first press in the Coupler Tightly (to provide clearance to the locking device), then operate the tab fully and remove the coupler in the designated manner.

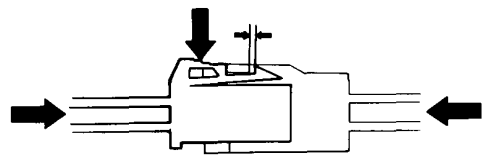



- When disconnecting a coupler, pull it off from the mating coupler by holding on both couplers.
- Never try to disconnect couplers by pulling on their wires.



- Before connecting couplers, check to see that the terminals are in place and are not bent or distorted.

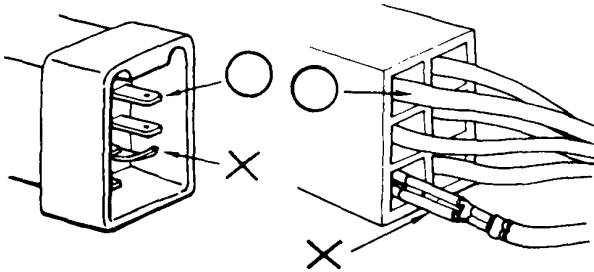

- Insert couplers fully until they will no longer go.
- Some couplers have locking tabs that must be aligned and engaged securely.
- Don't use wire harnesses with a loose wire or coupler.

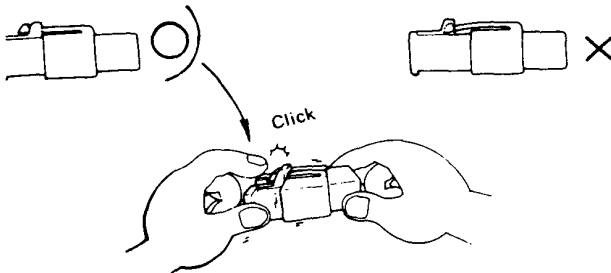

- Place the plastic cover over the mating coupler after reconnecting. Also check that the end is not inverted.

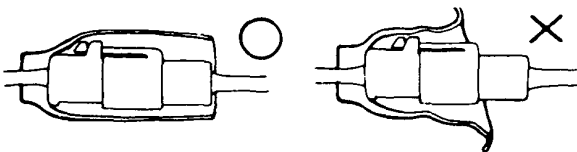

- Before connecting, check each connector cover for breakage. Also make sure that the female connector is tight and not pried open from the previous use.

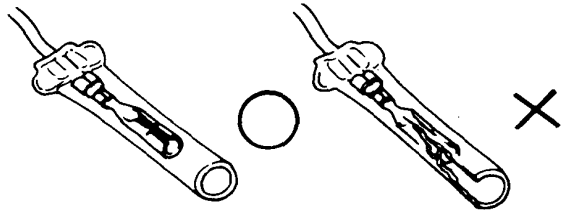

- Insert male connectors into the female connectors fully until they will no longer go.
- Be sure that plastic cover is placed over the connection.
- Don't place the opening of each plastic cover facing up.

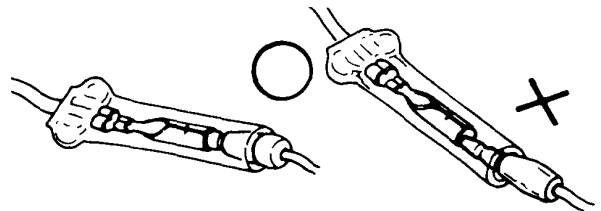

- Secure wires and wire harnesses to the frame with their respective wire bands at the designated locations. Tighten the bands so that only the insulated surfaces contact the wires or wire harnesses.

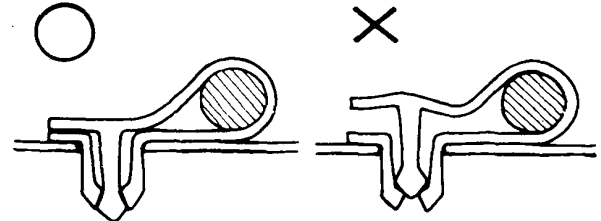

- A loose wire harness or cable can be a hazard to safety. After clamping, check each wire for security in its clamp.

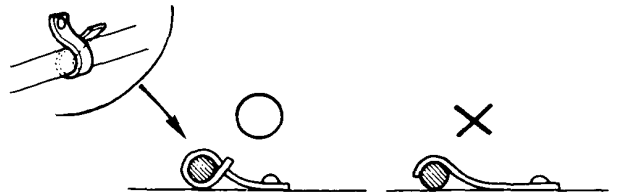

- Do not squeeze wires against the weld or nugget of its clamp when a weld-on clamp is used.



(cont'd)

Preparation of Work

Electrical (cont'd)

- After clamping, check each harness to be certain that it is not interfering with any moving or sliding parts of the vehicle.
- Keep wire harnesses away from the exhaust pipes and other hot parts.

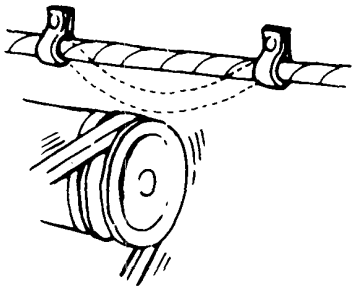

- Always keep a safe distance between wire harnesses and any heated parts.

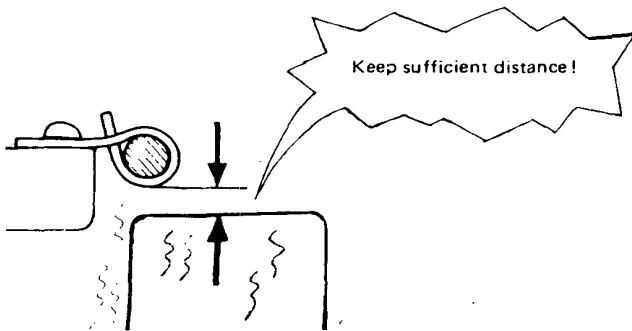

- Do not bring wire harnesses in direct contact with sharp edges or corners.
- Also avoid contact with the projected ends of bolts, screws and other fasteners.

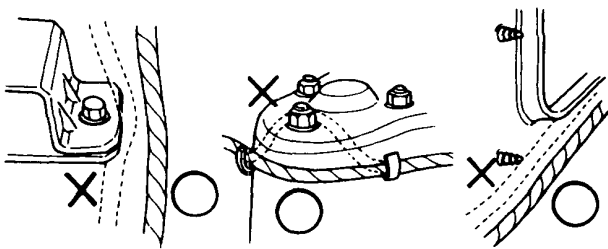

- Route harnesses so they are not pulled taut or slackened excessively.

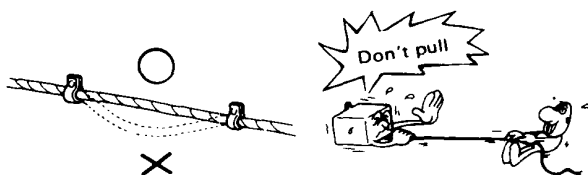

- Protect wires and harnesses with a tape or tube if they are in contact with a sharp edge or corner.

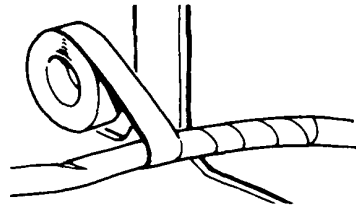

- Clean the attaching surface thoroughly if a plaster is used. Use a spirit wipe if necessary.

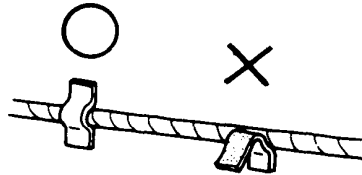

- Seat grommets in their grooves properly.

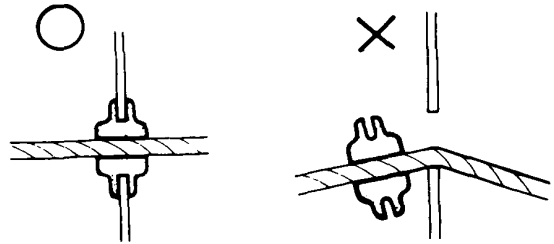

- Do not damage the insulator when connecting a wire.
- Do not use wires or harnesses with a broken insulator. Repair by wrapping with a protective tape or replace with new ones if necessary.

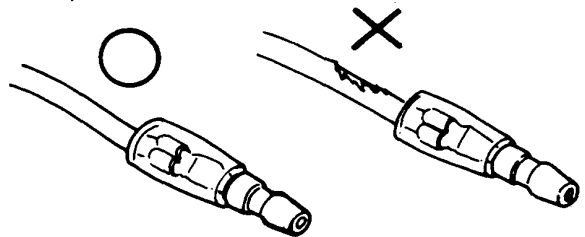

- After installing parts, make sure that wire harnesses are not pinched.

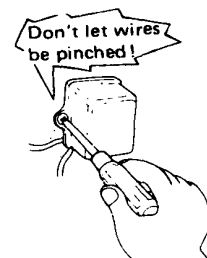



- After routing, check that the wire harnesses are not twisted or kinked.

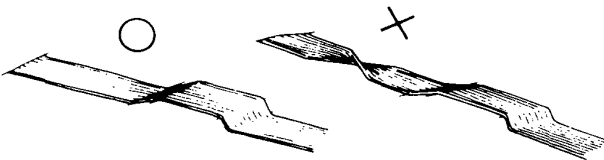

- Wire harnesses should be routed so that they are not pulled taut, slackened excessively, pinched, or interfered with adjacent or surrounding parts in all steering positions.

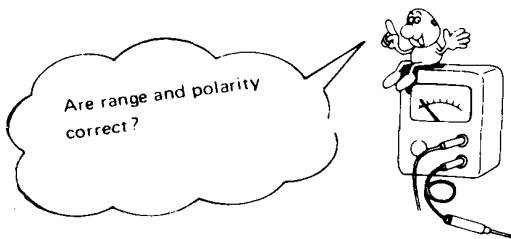

- When using the Service Tester, follow the manufacturer's instructions and those described in the Shop Manual.

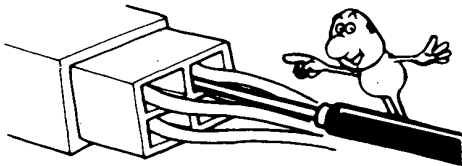

- Do not throw or let parts fall.

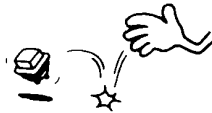

- Rust is the enemy of all finished surfaces. Before connecting connectors and couplers, check the terminals and remove, if any, rust using a fine sand paper or emery cloth.



Symbol Marks

The following symbols stand for:



:Apply engine oil.



:Apply brake fluid.



:Apply grease.



:Apply Automatic Transmission Fluid.



:Apply Power Steering Fluid.



Special Tools

Newly Provided Tools	2-2
Special Tools (Common with Other Models) ...	2-2

Special Tools

Newly Provided Tools

Ref. No.	Tool Number	Description	Q'ty	Remarks	Section
①	07GAC—SE00200	Fuel Sender Wrench	1		11
②	07411—0020000	Digital Circuit Tester	1		11
③	07406—0040000	Fuel Pressure Gauge Set	1		11
④	07999—PD6000A	System Checker Harness	1		11
⑤	07GAZ—SE00300	R.P.M. Connecting Adaptor	1		11
⑥	07GAC—PF40100	Transmission Housing Puller	1		14 and 15
⑦	07GAB—PF50100	Mainshaft Holder	1		15
⑧	07GAC—PF40210	Bearing Remover Attachment	1		15
⑨	07406—0070000	Low Pressure Gauge	1		15
⑩	07GAK—SE00100	Joint Adaptor Kit	1		18
⑪	07GAF—SE00100	Hub Assembly Pin	1		19
⑫	07GAF—SE00200	Hub Assembly Driver Attachment	1		19
⑬	07GAF—SE00400	Front Hub Driver Base	1		19
⑭	07GAE—SE00100	Absorber Spring Compressor	1		19
⑮	07GAC—SE00100	Ball Joint Remover	1		19
⑯	07GAG—SE00100	Brake Booster Adjusting Gauge	1		20
⑰	07GAF—SE00300	Pulser Driver Attachment	1		20
⑱	07GAZ—SE00100	A.L.B. Hand Pump Assembly	1		20
⑲	07GAZ—SE00200	A.L.B. Checker Harness Adaptor	1		20

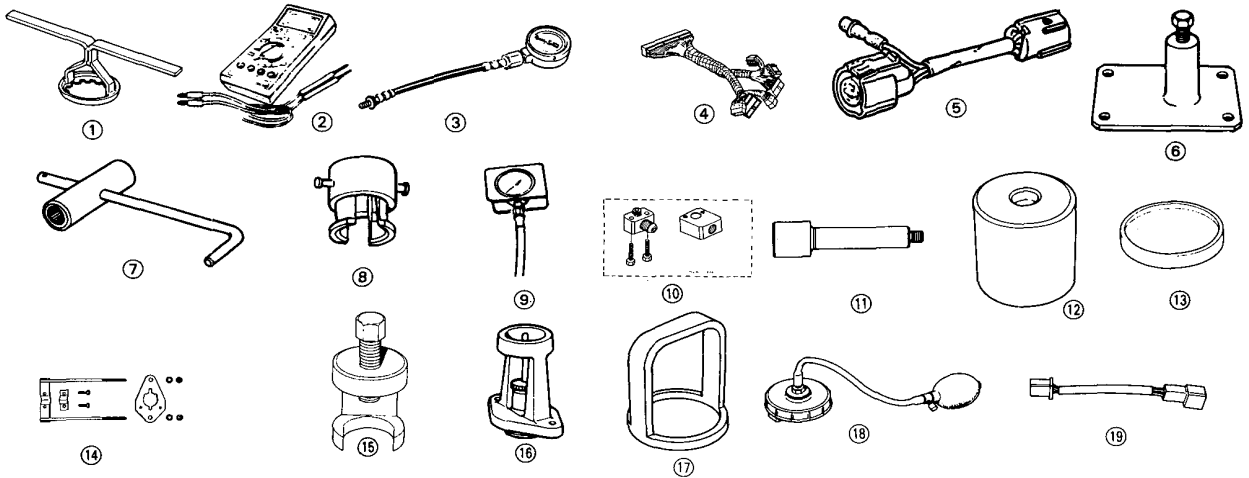

Special Tools (Common with Other Models)

5. Engine Removal/Installation

Ref. No.	Tool Number	Description	Q'ty	Remarks
①	07941—6920002	Ball Joint Remover	1	
②	07966—6340011	Engine Block Hanger	1	

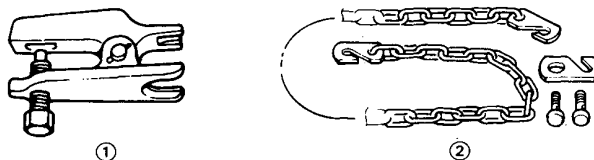





Special Tools (Common with Other Models)

6. Cylinder Head/Valve Train

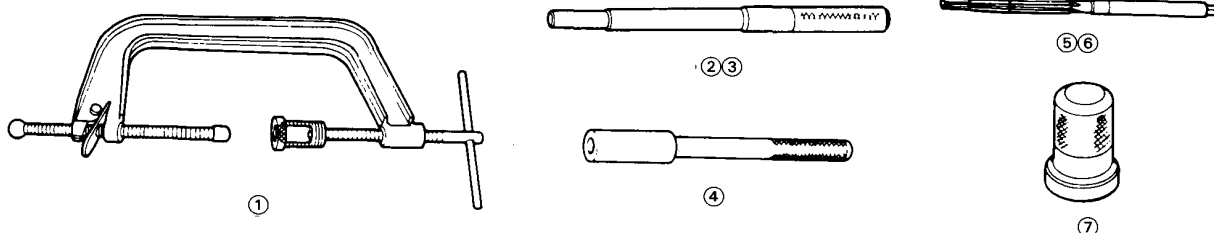
Ref. No.	Tool Number	Description	Q'ty	Remarks
①	07757-0010000	Valve Spring Compressor	1	07957-3290001 may also be used 07742-0010200 may also be used
②	07942-6110000	Valve Guide Driver/Remover	1	
③	07942-SA50000	Valve Guide Driver/Remover	1	
④	07743-0020000	Valve Guide Driver	1	
⑤	07984-6110000	Valve Guide Reamer	1	
⑥	07984-SA50000	Valve Guide Reamer	1	
⑦	07947-SB00100	Oil Seal Driver	1	



7. Engine Block

Ref. No.	Tool Number	Description	Q'ty	Remarks	
①	07973-6570002	Piston Pin Insert Base Set	1	 Not included in base set. Use each with the base set.	
②	07973-SB00100	Piston Pilot	1		
③	07973-SB00200	Piston Pin Insert Attachment A	1		
④	07973-PE00302	Piston Pin Pilot Collar	1		
⑤	07973-SB00400	Piston Pin Insert Attachment B	1		
⑥	07948-SB00101	Driver Attachment	1		Crankshaft Oil Seal (Clutch side)
⑦	07947-SB00200	Oil Seal Driver	1		Crankshaft Oil Seal
⑧	07749-0010000	Driver	1		07949-6110000 may also be used

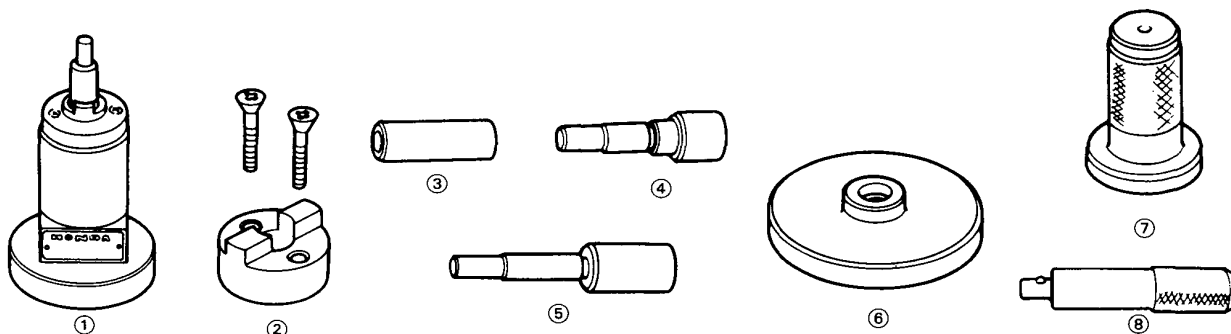

(cont'd)

Special Tools

Special Tools (Common with Other Models)

8. Engine Lubrication

Ref. No.	Tool Number	Description	Q'ty	Remarks
①	07912-6110001	Oil Filter Socket Wrench	1	
②	07406-0030000	Oil Pressure Gauge Adaptor	1	

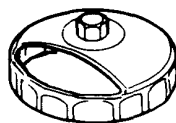

①

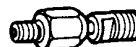

②

11. Fuel and Carburetor

Ref. No.	Tool Number	Description	Q'ty	Remarks
①	07614-0050100	Fuel Line Clip	1	
*②	07GAC-SE00200	Fuel Sender Wrench	1	
*③	07406-0040001	Fuel Pressure Gauge Set	1	
*③-1	07406-0040100	Pressure Gauge	(1)	Component Tools
*③-2	07406-0040201	Hose Assy	(1)	
*④	07999-PD6000A	System Checker Harness	1	A20A4 Engine only
*⑤	07411-0020000	Digital Circuit Tester	1	A20A4 Engine only
⑥	07GAZ-SE00300	R.P.M. Connecting Adaptor	1	Carbureted Engine only

* Newly Provided Tools

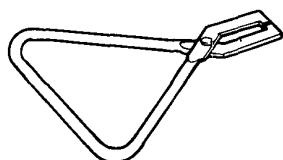

①

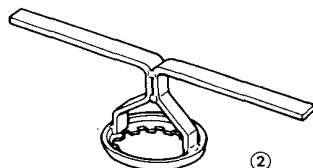

②

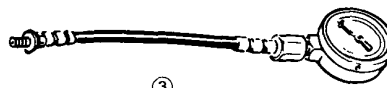

③

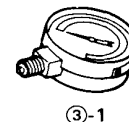

③-1



③-2

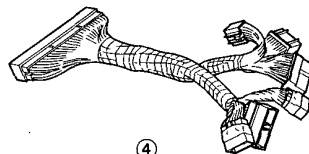

④

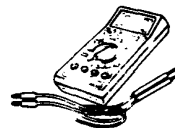

⑤

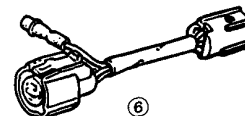

⑥

13. Clutch

Ref. No.	Tool Number	Description	Q'ty	Remarks
①	07924-PD20001	Ring Gear Holder	1	
②	07974-6890101	Clutch Disc Alignment Tool	1	

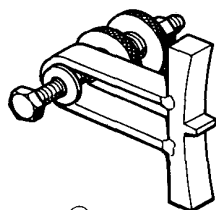

①

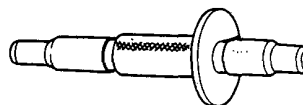

②