

Technical Manual

(Troubleshooting)

ZAXIS

210W

Wheeled Excavator

Service Manual (Manual No. KM-CDBE) consists of the following three separate volumes;

Technical Manual (Operational Principle)	: Vol. No. TOCDBE
Technical Manual (Troubleshooting)	: Vol. No. TTCDBE
Workshop Manual	: Vol. No. WCDBE

HITACHI

INTRODUCTION

TO THE READER

- This manual is written for an experienced technician to provide technical information needed to maintain and repair this machine.
- Be sure to thoroughly read this manual for correct product information and service procedures.
- If you have any questions or comments, at if you found any errors regarding the contents of this manual, please contact using "Service Manual Revision Request Form" at the end of this manual.
(Note: Do not tear off the form. Copy it for usage.)
Publications Marketing & Product Support
Hitachi Construction Machinery Co. Ltd.
TEL: 81-298-32-7173
FAX: 81-298-31-1162

ADDITIONAL REFERENCES

- Please refer to the materials listed below in addition to this manual.
 - The Operator's Manual
 - The Parts Catalog
 - Operation Manual of the Engine
 - Parts Catalog of the Engine
 - Hitachi Training Material

MANUAL COMPOSITION

- This manual consists of three portions: the Technical Manual (Operational Principle), the Technical Manual (Troubleshooting) and the Workshop Manual.
- Information included in the Technical Manual (Operational Principle):
technical information needed for redelivery and delivery, operation and activation of all devices and systems.
- Information included in the Technical Manual (Troubleshooting):
technical information needed for operational performance tests, and troubleshooting procedures.
- Information included in the Workshop Manual:
technical information needed for maintenance and repair of the machine, tools and devices needed for maintenance and repair, maintenance standards, and removal/installation and assemble/disassemble procedures.

INTRODUCTION

PAGE NUMBER

- Each page has a number, located on the center lower part of the page, and each number contains the following information:

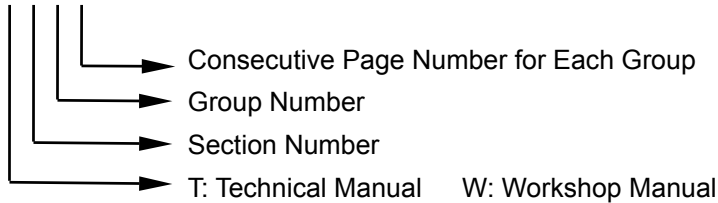

Example : T 1-3-5



SAFETY ALERT SYMBOL AND HEADLINE NOTATIONS

In this manual, the following safety alert symbol and signal words are used to alert the reader to the potential for personal injury or machine damage.

 This is the safety alert symbol. When you see this symbol, be alert to the potential for personal injury. Never fail to follow the safety instructions prescribed along with the safety alert symbol. The safety alert symbol is also used to draw attention to component/part weights. To avoid injury and damage, be sure to use appropriate lifting techniques and equipment when lifting heavy parts.

-  **CAUTION:**
Indicated potentially hazardous situation which could, if not avoided, result in personal injury or death.
- **IMPORTANT:**
Indicates a situation which, if not conformed to the instructions, could result in damage to the machine.
-  **NOTE:**
Indicates supplementary technical information or know-how.

INTRODUCTION

UNITS USED

- SI Units (International System of Units) are used in this manual.

MKSA system units and English units are also indicated in parentheses just behind SI units.

Example : 24.5 MPa (250 kgf/cm², 3560 psi)

A table for conversion from SI units to other system units is shown below for reference purposes.

Quantity	To Convert From	Into	Multiply By	Quantity	To Convert From	Into	Multiply By
Length	mm	in	0.03937	Pressure	MPa	kgf/cm ²	10.197
	mm	ft	0.003281		MPa	psi	145.0
Volume	L	US gal	0.2642	Power	kW	PS	1.360
	L	US qt	1.057		kW	HP	1.341
	m ³	yd ³	1.308	Temperature	°C	°F	°C×1.8+32
Weight	kg	lb	2.205	Velocity	km/h	mph	0.6214
Force	N	kgf	0.10197		min ⁻¹	rpm	1.0
	N	lbf	0.2248	Flow rate	L/min	US gpm	0.2642
Torque	N·m	kgf·m	1.0197		mL/rev	cc/rev	1.0
	N·m	lbf·ft	0.7375				

INTRODUCTION

(Blank)

SAFETY

RECOGNIZE SAFETY INFORMATION

- This is the **SAFETY ALERT SYMBOL**.
 - When you see this symbol on your machine or in this manual, be alert to the potential for personal injury.
 - Follow recommended precautions and safe operating practices.

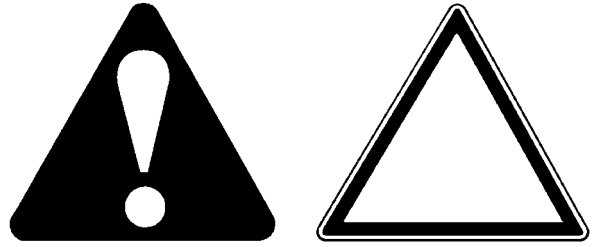

001-E01A-0688

SA-688

UNDERSTAND SIGNAL WORDS

- On machine safety signs, signal words designating the degree or level of hazard - **DANGER**, **WARNING**, or **CAUTION** - are used with the safety alert symbol.
 - **DANGER** indicates an imminently hazardous situation which, if not avoided, will result in death or serious injury.
 - **WARNING** indicates a potentially hazardous situation which, if not avoided, could result in death or serious injury.
 - **CAUTION** indicates a potentially hazardous situation which, if not avoided, may result in minor or moderate injury.

DANGER or WARNING safety signs are located near specific hazards. General precautions are listed on **CAUTION safety signs**.

 - Some safety signs don't use any of the designated signal words above after the safety alert symbol are occasionally used on this machine.
- **CAUTION** also calls attention to safety messages in this manual.
- To avoid confusing machine protection with personal safety messages, a signal word **IMPORTANT** indicates a situation which, if not avoided, could result in damage to the machine.
-  **NOTE** indicates an additional explanation for an element of information.



002-E01C-1223

SA-1223

SAFETY

FOLLOW SAFETY INSTRUCTIONS

- Carefully read and follow all safety signs on the machine and all safety messages in this manual.
- Safety signs should be installed, maintained and replaced when necessary.
 - If a safety sign or this manual is damaged or missing, order a replacement from your authorized dealer in the same way you order other replacement parts (be sure to state machine model and serial number when ordering).
- Learn how to operate the machine and its controls correctly and safely.
- Allow only trained, qualified, authorized personnel to operate the machine.
- Keep your machine in proper working condition.
 - Unauthorized modifications of the machine may impair its function and/or safety and affect machine life.
- The safety messages in this SAFETY chapter are intended to illustrate basic safety procedures of machines. However it is impossible for these safety messages to cover every hazardous situation you may encounter. If you have any questions, you should first consult your supervisor and/or your authorized dealer before operating or performing maintenance work on the machine.

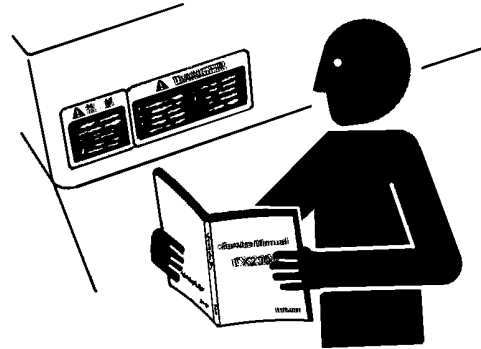

SA-003

003-E01B-0003

SAFETY

PREPARE FOR EMERGENCIES

- Be prepared if a fire starts or if an accident occurs.
 - Keep a first aid kit and fire extinguisher on hand.
 - Thoroughly read and understand the label attached on the fire extinguisher to use it properly.
 - To ensure that a fire-extinguisher can be always used when necessary, check and service the fire-extinguisher at the recommended intervals as specified in the fire-extinguisher manual.
 - Establish emergency procedure guidelines to cope with fires and accidents.
 - Keep emergency numbers for doctors, ambulance service, hospital, and fire department posted near your telephone.



SA-437

004-E01A-0437

WEAR PROTECTIVE CLOTHING

- Wear close fitting clothing and safety equipment appropriate to the job.
You may need:
 - A hard hat
 - Safety shoes
 - Safety glasses, goggles, or face shield
 - Heavy gloves
 - Hearing protection
 - Reflective clothing
 - Wet weather gear
 - Respirator or filter mask.
- Be sure to wear the correct equipment and clothing for the job. Do not take any chances.
 - Avoid wearing loose clothing, jewelry, or other items that can catch on control levers or other parts of the machine.
- Operating equipment safely requires the full attention of the operator. Do not wear radio or music headphones while operating the machine.

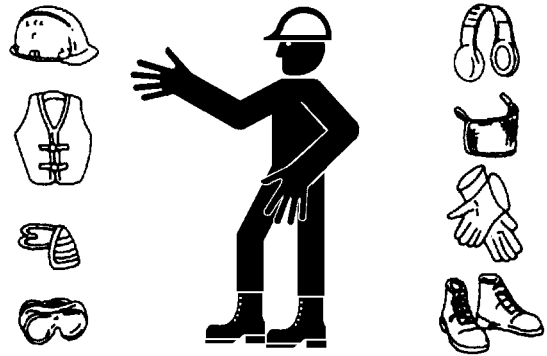

SA-438

005-E01A-0438

SAFETY

PROTECT AGAINST NOISE

- Prolonged exposure to loud noise can cause impairment or loss of hearing.
 - Wear a suitable hearing protective device such as earmuffs or earplugs to protect against objectionable or uncomfortably loud noises.



006-E01A-0434

SA-434

INSPECT MACHINE

- Inspect your machine carefully each day or shift by walking around it before you start it to avoid personal injury.
 - In the walk-around inspection be sure to cover all points described in the “PRE-START INSPECTION” chapter in the operator’s manual.



S007-E01A-0435

SA-435

SAFETY

GENERAL PRECAUTIONS FOR CAB

- Before entering the cab, thoroughly remove all dirt and/or oil from the soles of your work boots. If any controls such as a pedal is operated while with dirt and/or oil on the soles of the operator's work boots the operator's foot may slip off the pedal, possibly resulting in a personal accident.
- Don't leave parts and/or tools lying around the operator's seat. Store them in their specified locations.
- Avoid storing transparent bottles in the cab. Don't attach any transparent type window decorations on the windowpanes as they may focus sunlight, possibly starting a fire.
- Refrain from listening to the radio, or using music headphones or mobile telephones in the cab while operating the machine.
- Keep all flammable objects and/or explosives away from the machine.
- After using the ashtray, always cover it to extinguish the match and/or tobacco.
- Don't leave cigarette lighters in the cab. When the temperature in the cab increases, the lighter may explode.

524-E01A-0000

SAFETY

USE HANDHOLDS AND STEPS

- Falling is one of the major causes of personal injury.
 - When you mounting and dismounting the machine, always face the machine and maintain a three-point contact with the steps and handrails.
 - Do not use any controls as hand-holds.
 - Never jump on or off the machine. Never mount or dismount a moving machine.
 - Be careful of slippery conditions on platforms, steps, and handrails when mounting and dismounting the machine.

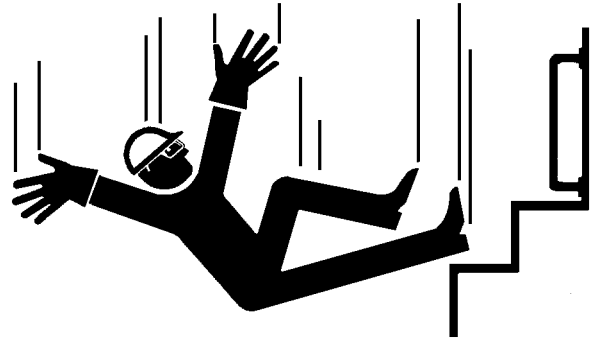

SA-439

008-E01B-0439

ADJUST THE OPERATOR'S SEAT

- A poorly adjusted seat for either the operator or for the work at hand may quickly fatigue the operator leading to misoperations.
 - The seat should be adjusted whenever changing the operator for the machine.
 - The operator should be able to fully depress the pedals and to correctly operate the control levers with his back against the seat back.
 - If not, move the seat forward or backward, and check again.



SA-378

009-E01A-0378

SAFETY

FASTEN YOUR SEAT BELT

- If the machine should overturn, the operator may become injured and/or thrown from the cab. Additionally the operator may be crushed by the overturning machine, resulting in serious injury or death.
 - Prior to operating the machine, thoroughly examine webbing, buckle and attaching hardware. If any item is damaged or worn, replace the seat belt or component before operating the machine.
 - Be sure to remain seated with the seat belt securely fastened at all times when the machine is in operation to minimize the chance of injury from an accident.
 - We recommend that the seat belt be replaced every three years regardless of its apparent condition.

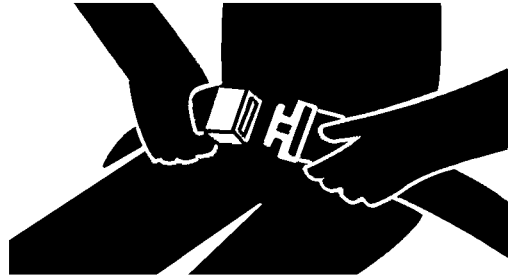

SA-237

010-E01A-0237

MOVE AND OPERATE MACHINE SAFELY

- Bystanders can be run over.
 - Take extra care not to run over bystanders. Confirm the location of bystanders before moving, swinging, or operating the machine.
 - Always keep the travel alarm and horn in working condition (if equipped). It warns people when the machine starts to move.
 - Use a signal person when moving, swinging, or operating the machine in congested areas. Coordinate hand signals before starting the machine.

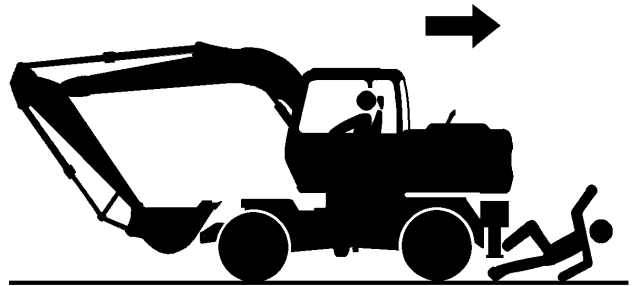

SA-083

011-E01A-0426

SAFETY

OPERATE ONLY FROM OPERATOR'S SEAT

- Inappropriate engine starting procedures may cause the machine to runaway, possibly resulting in serious injury or death.
 - Start the engine only when seated in the operator's seat.
 - NEVER start the engine while standing on the track or on ground.
 - Do not start engine by shorting across starter terminals.
 - Before starting the engine, confirm that all control levers are in neutral.

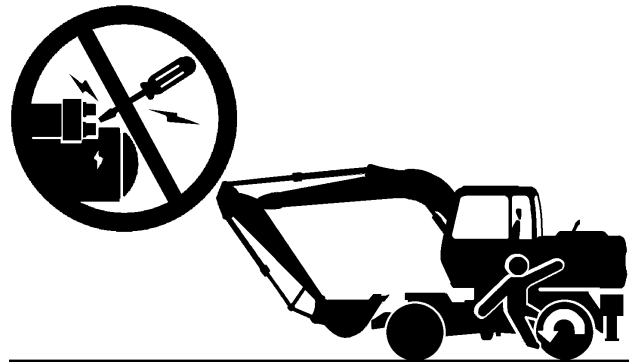

SA-084

012-E01B-0444

JUMP STARTING

- Battery gas can explode, resulting in serious injury.
 - If the engine must be jump started, be sure to follow the instructions shown in the "OPERATING THE ENGINE" chapter in the operator's manual.
 - The operator must be in the operator's seat so that the machine will be under control when the engine starts. Jump starting is a two-person operation.
 - Never use a frozen battery.
 - Failure to follow correct jump starting procedures could result in a battery explosion or a runaway machine.

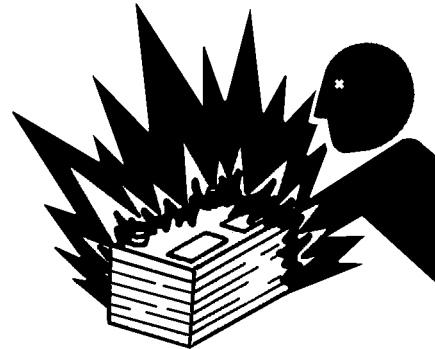

SA-032

S013-E01A-0032

SAFETY

KEEP RIDERS OFF MACHINE

- Riders on machine are subject to injury such as being struck by foreign objects and being thrown off the machine.
 - Only the operator should be on the machine. Keep riders off.
 - Riders also obstruct the operator's view, resulting in the machine being operated in an unsafe manner.

014-E01B-0379

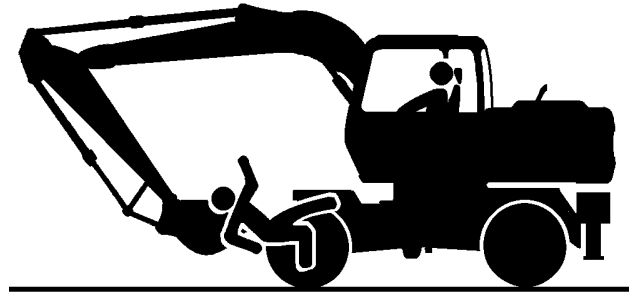

SA-091

PROVIDE SIGNALS FOR FOBS INVOLVING MULTIPLE NUMBERS OF MACHINES

- For jobs involving multiple numbers of machines, provide signals commonly known by all personnel involved. Also, appoint a signal person to coordinate the job site. Make sure that all personnel obey the signal person's directions.

018-E01A-0481



SA-481

CONFIRM DIRECTION OF MACHINE TO BE DRIVEN

- Incorrect steering wheel shift lever operation may result in serious injury death.
 - Before driving the machine, confirm the position of the undercarriage in relation to the operator's position. If the travel motors are located in front of the cab, the machine will move in reverse when travel pedals/levers are operated to the front.

017-E01A-0491



SA-092

SAFETY

DRIVE MACHINE SAFELY (WORK SITE)

- Before driving the machine, always confirm that the steering wheel/shift lever direction corresponds to the direction you wish to drive.
 - Be sure to detour around any obstructions.
- Driving on a slope may cause the machine to slip or overturn, possibly resulting in serious injury or death.
 - When driving up or down a slope, keep the bucket facing the direction of travel, approximately 0.5 to 1.0 m (A) above the ground.
 - If the machine starts to skid or becomes unstable, immediately lower the bucket to the ground and stop.

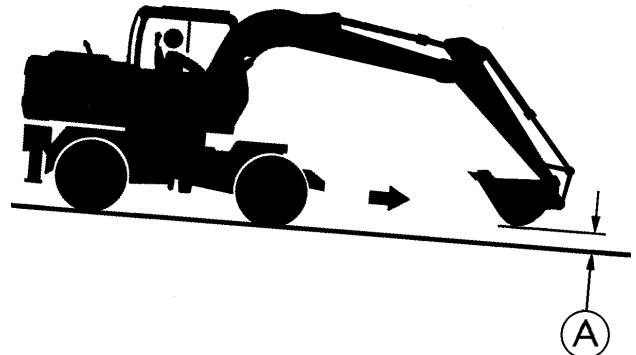
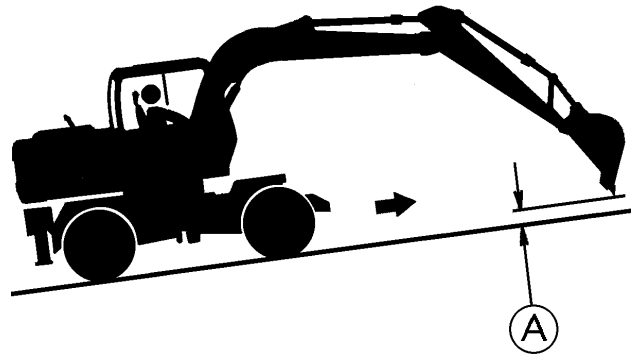

- Driving across the face of a slope or steering on a slope may cause the machine to skid or overturn. If the direction must be changed, move the machine to level ground, then, change the direction to ensure safe operation.

019-E05B-0090

SAFETY

AVOID INJURY FROM ROLLAWAY ACCIDENTS

- Death or serious injury may result if you attempt to mount or stop a moving machine.

To avoid rollaways:

- Select level ground when possible to park machine.
- Do not park the machine on a grade.
- Lower the bucket and/or other work tools to the ground.
- Place the shift lever in neutral, and put the brake switch in the P (parking brake) position.
- Turn the auto-idle switch and the H/P mode switch off.
- Run the engine at slow idle speed without load for 5 minutes to cool down the engine.
- Stop the engine and remove the key from the key switch.
- Pull the pilot control shut-off lever to LOCK position.
- Block both tires and lower the bucket to the ground. Thrust the bucket teeth into the ground if you must park on a grade.
- Position the machine to prevent rolling.
- Park a reasonable distance from other machines.

020-E01A-0270

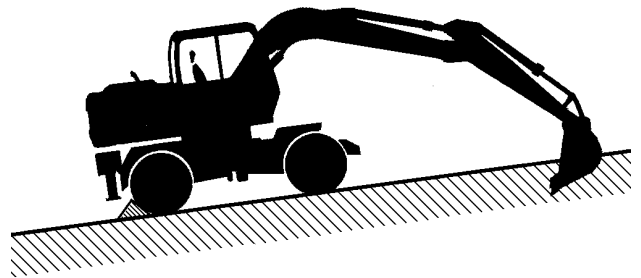
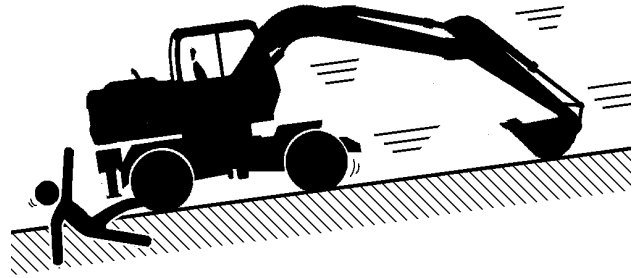

SA-278

SAFETY

AVOID INJURY FROM BACK-OVER AND SWING ACCIDENTS

- If any person is present near the machine when backing or swinging the upperstructure, the machine may hit or run over that person, resulting in serious injury or death.

To avoid back-over and swing accidents:

- Always look around BEFORE YOU BACK UP AND SWING THE MACHINE. BE SURE THAT ALL BYSTANDERS ARE CLEAR.
- Keep the travel alarm in working condition (if equipped).
ALWAYS BE ALERT FOR BYSTANDERS MOVING INTO THE WORK AREA. USE THE HORN OR OTHER SIGNAL TO WARN BYSTANDERS BEFORE MOVING MACHINE.
- USE A SIGNAL PERSON WHEN BACKING UP IF YOUR VIEW IS OBSTRUCTED. ALWAYS KEEP THE SIGNAL PERSON IN VIEW.
Use hand signals, which conform to your local regulations, when work conditions require a signal person.
- No machine motions shall be made unless signals are clearly understood by both signalman and operator.
- Learn the meanings of all flags, signs, and markings used on the job and confirm who has the responsibility for signaling.
- Keep windows, mirrors, and lights clean and in good condition.
- Dust, heavy rain, fog, etc., can reduce visibility. As visibility decreases, reduce speed and use proper lighting.
- Read and understand all operating instructions in the operator's manual.

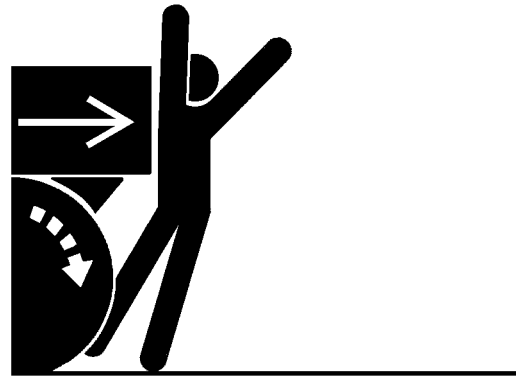

SA-383

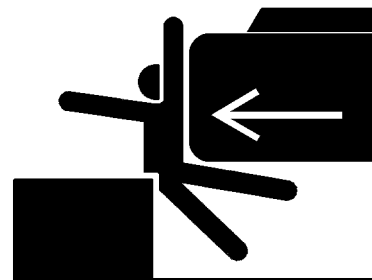

SA-384

S021-E01A-0494

SAFETY

AVOID TIPPING

DO NOT ATTEMPT TO JUMP CLEAR OF TIPPING MACHINE---SERIOUS OR FATAL CRUSHING INJURIES WILL RESULT

MACHINE WILL TIP OVER FASTER THAN YOU CAN JUMP FREE

FASTEN YOUR SEAT BELT

- The danger of tipping is always present when operating on a grade, possibly resulting in serious injury or death.

To avoid tipping:

- Be extra careful before operating on a grade.
 - Prepare machine operating area flat.
 - Keep the bucket low to the ground and close to the machine.
 - Reduce operating speeds to avoid tipping or slipping.
 - Avoid changing direction when traveling on grades.
 - NEVER attempt to travel across a grade steeper than 5 degrees if crossing the grade is unavoidable.
 - Reduce swing speed as necessary when swinging loads.
- Be careful when working on frozen ground.
 - Temperature increases will cause the ground to become soft and make ground travel unstable.

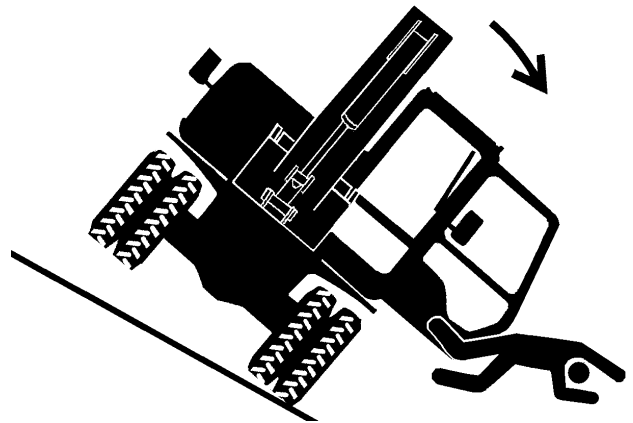

SA-012

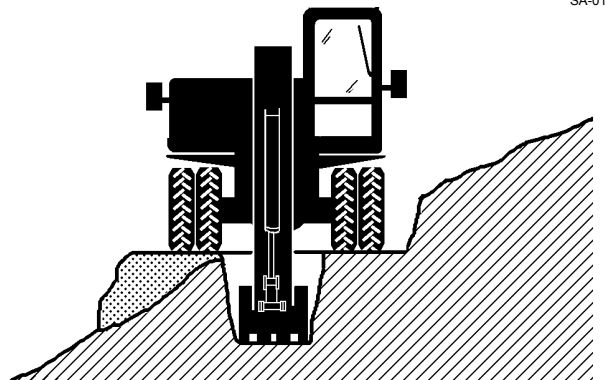

SA-562

S025-E01B-0495

SAFETY

AVOID POWER LINES

- Serious injury or death can result if the machine or front attachments are not kept a safe distance from electric lines.
 - When operating near an electric line, NEVER move any part of the machine or load closer than 3 m (10 ft) plus twice the line insulator length.
 - Check and comply with any local regulations that may apply.
 - Wet ground will expand the area that could cause any person on it to be affected by electric shock. Keep all bystanders or co-workers away from the site.

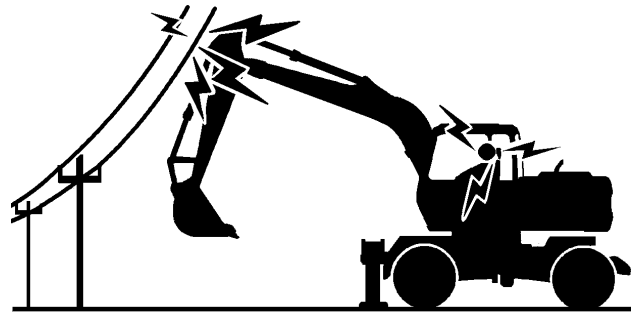

SA-089

029-E01A-0381

OBJECT HANDLING

- If a lifted load should fall, any person nearby may be struck by the falling load or may be crushed underneath it, resulting in serious injury or death.
 - When using the machine for craning operations, be sure to comply with all local regulations.
 - Do not use damaged chains or frayed cables, cables, slings, or ropes.
 - Before craning, position the upperstructure with the travel motors at the rear.
 - Move the load slowly and carefully. Never move it suddenly.
 - Keep all persons well away from the load.
 - Never move a load over a person's head.
 - Do not allow anyone to approach the load until it is safely and securely situated on supporting blocks or on the ground.
 - Never attach a sling or chain to the bucket teeth. They may come off, causing the load to fall.

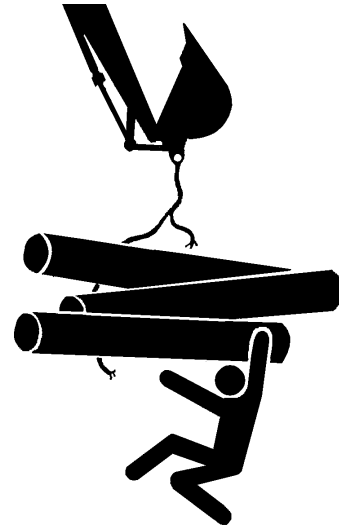

SA-014

032-E01A-0014

SAFETY

PROTECT AGAINST FLYING DEBRIS

- If flying debris hit eyes or any other part of the body, serious injury may result.
 - Guard against injury from flying pieces of metal or debris; wear goggles or safety glasses.
 - Keep bystanders away from the working area before striking any object.

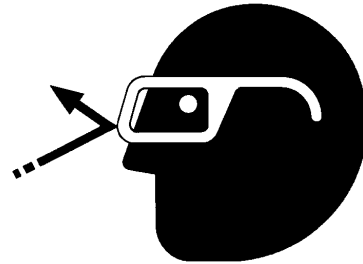

031-E01A-0432

SA-432

PARK MACHINE SAFELY

To avoid accidents:

- Park machine on a firm, level surface.
- Lower bucket to the ground.
- Place the shift lever in neutral, and put the brake switch in the P (parking brake) position.
- Turn auto-idle switch and auto-acceleration switch off.
- Run engine at slow idle speed without load for 5 minutes.
- Turn key switch to OFF to stop engine.
- Remove the key from the key switch.
- Pull up the pilot shut-off lever further to release the catch, so that the left console can be moved upward ("CONSOLE UP" position).
- Close windows, roof vent, and cab door.
- Lock all access doors and compartments.



SA-093

033-E07B-0093