

# Chapter 1

## Routine maintenance and servicing







1

### Contents

Air cleaner element renewal . . . . .	24	Handbrake adjustment . . . . .	27
Automatic transmission fluid level check . . . . .	20	Idle speed and mixture check and adjustment . . . . .	9
Automatic transmission fluid renewal . . . . .	26	Idle speed control valve cleaning and maintenance . . . . .	22
Auxiliary drivebelt check and renewal . . . . .	4	Intensive maintenance . . . . .	2
Bodywork, paint and exterior trim check . . . . .	18	Introduction . . . . .	1
Brake check . . . . .	14	Manual transmission oil level check . . . . .	8
Brake fluid renewal . . . . .	31	Road test . . . . .	19
Coolant renewal . . . . .	23	Roadwheel nut tightness check . . . . .	15
Door, tailgate and bonnet check and lubrication . . . . .	16	Seat belt check . . . . .	17
Driveshaft rubber gaiter and CV joint check . . . . .	11	Spark plug renewal and HT component check . . . . .	21
Emission control system check . . . . .	25	Steering, suspension and roadwheel check . . . . .	10
Engine compartment wiring check . . . . .	6	Timing belt renewal . . . . .	29
Engine oil and filter renewal . . . . .	3	Underbody and fuel/brake line check . . . . .	13
Exhaust system check . . . . .	12	Underbonnet check for fluid leaks and hose condition . . . . .	5
Front wheel alignment check . . . . .	28	Valve clearance adjustment . . . . .	7
Fuel filter renewal . . . . .	30		

### Degrees of difficulty

<p><b>Easy</b>, suitable for novice with little experience</p> 	<p><b>Fairly easy</b>, suitable for beginner with some experience</p> 	<p><b>Fairly difficult</b>, suitable for competent DIY mechanic</p> 	<p><b>Difficult</b>, suitable for experienced DIY mechanic</p> 	<p><b>Very difficult</b>, suitable for expert DIY or professional</p> 
--	---	---	--	---

# 1.2 Servicing Specifications

## Lubricants and fluids

Refer to end of "Weekly Checks"

### Capacities

#### Engine oil

At oil and filter change:

HCS engines	3.25 litres
CVH and PTE engines	3.50 litres
Zetec engines	4.25 litres
Difference between dipstick minimum and maximum level notches	0.5 to 1.0 litre

#### Cooling system

HCS engines	7.1 litres
CVH and PTE engines	7.6 litres
Zetec engines	7.0 litres

Fuel tank 42.0 litres

Manual transmission 3.1 litres

Automatic transmission 3.5 litres

### Engine

Direction of crankshaft rotation Clockwise (seen from right-hand side of vehicle)

Oil filter:

HCS, CVH and PTE engines	Champion C104
Zetec engines	Champion C148

### Cooling system

Coolant protection at standard 40% antifreeze/water mixture ratio:

Slush point	-25°C (-13°F)
Solidifying point	-30°C (-22°F)

Coolant specific gravity at standard 40% antifreeze/water

mixture ratio and 15°C/59°F - with no other additives in coolant 1.061

### Fuel system

Idle speed\*:

1.0, 1.1 and 1.3 litre HCS (carburettor) engines	750 ± 50 rpm (cooling fan running)
1.4 and 1.6 litre CVH (carburettor) engines:	
Manual transmission	800 ± 50 rpm (cooling fan running)
CTX automatic transmission	850 ± 50 rpm (cooling fan running)
1.6 litre CVH (EFI fuel injection) engines:	
Idle speed	900 ± 50 rpm
Base idle speed	750 ± 50 rpm

Idle mixture CO content\*:

1.0, 1.1 and 1.3 litre HCS (carburettor) engines	1.0 ± 0.5%
1.4 litre CVH (carburettor) engines	1.5 ± 0.25%
1.6 litre CVH (carburettor) engines	1.5 ± 0.5%
1.6 litre CVH (fuel injection) engines:	
Non turbo models	0.8 ± 0.25%
Turbo models	1.5 ± 0.25%

\*Note: The idle speed and mixture CO content is only adjustable on the engines shown above. On all other engines, it is controlled by the engine management system, and cannot be checked or adjusted without specialised test equipment.

Air filter element:

1.0, 1.1 and 1.3 litre HCS engines	Champion W153
1.4 litre CVH and PTE engines	Champion W226
1.6 litre CVH (carburettor) engines	Champion W226
1.6 litre CVH (fuel injection) engines	Champion U557
1.6 and 1.8 litre Zetec engines	Champion U612

Fuel filter:

HCS, CVH (fuel injection) and PTE engines:	
Without quick-release fuel line fittings	Champion L204
With quick-release fuel line fittings	Champion type not available
Zetec engines	Champion L218

## Ignition system

### Firing order:

HCS engines	1-2-4-3 (No 1 cylinder at timing chain end of engine)
All other engines	1-3-4-2 (No 1 cylinder at timing belt end of engine)

### Spark plugs\*:

HCS engines	Champion RS9YCC or RS9YC
1.4 and 1.6 litre CVH (carburettor) engines	Champion RC7YCC or RC7YC
1.6 litre CVH (EFI fuel injection) and PTE engines	
Non-turbo models	Champion RC7YCC4 or RC7YC4
Turbo models	Champion C61YC
1.6 and 1.8 litre Zetec engines	Champion RE7YCC

### Electrode gap\*:

HCS engines	1.0 mm
1.4 litre CVH (carburettor) engines	0.8 mm
1.4 litre CVH (CFi fuel injection) and PTE engine	1.0 mm
1.6 litre CVH (carburettor) engines:	
With Champion RC7YCC	0.8 mm
With Champion RC7YC	0.7 mm
1.6 litre CVH (EFI fuel injection) engines:	
Non-turbo models	1.0 mm
Turbo models	0.7 mm
1.6 and 1.8 litre Zetec engines	1.3 mm

### Spark plug (HT) leads:

HCS engines	Champion LS-28
1.4 and 1.6 litre CVH (carburettor) engines	Champion LS-14
1.4 litre CVH (CFi fuel injection) and PTE engines	Champion LS-14
1.6 litre CVH (EFI fuel injection) engines	Champion LS-26
1.6 and 1.8 litre Zetec engines	Champion type not available

Maximum resistance per lead 30 000 ohms

\* Information on spark plug types and electrode gaps is as recommended by Champion Spark Plug. Where alternative types are used, refer to their manufacturer's recommendations.

## Braking system

Minimum front brake pad lining thickness	1.5 mm
Minimum rear brake shoe lining thickness	1.0 mm

## Tyres

Tyre pressures See "Weekly Checks"

## Wiper blades

Windscreen	Champion X-4803
Tailgate/rear window	Champion X-4103

## Torque wrench settings

	Nm	lbf ft
Auxiliary drivebelt cover fasteners	8	6
Auxiliary drivebelt adjustment:		
Adjusting bolt (sliding arm)	22	16
Central (locking) bolt	22	16
Pinion (adjuster) nut	12	9
Alternator mounting bolts	24	18
Tensioner pulley centre bolt (HCS engines)	20	15
Engine oil drain plug	24	18
Manual transmission filler/level plug	20	15
Spark plugs:		
HCS engines	18	13
CVH and PTE engines	24	18
Zetec engines	15	11
Roadwheel nuts	71 to 100	52 to 74

## 1.4 Maintenance schedule

The maintenance schedule for these vehicles, based on the manufacturer's recommendations, is as described below - note that the schedule starts from the vehicle's date of registration. These are the minimum maintenance intervals recommended by the factory for Fiestas driven daily, but subjected only to "normal" use. If you wish to keep your vehicle in peak condition at all times, you may wish to perform some of these procedures even more often. Because frequent maintenance enhances the efficiency, performance and resale value of your vehicle, we encourage you to do so. If your usage is not "normal", shorter intervals

are also recommended - the most important examples of these are noted in the schedule. These shorter intervals apply particularly if you drive in dusty areas, tow a caravan or trailer, sit with the engine idling or drive at low speeds for extended periods (ie, in heavy traffic), or drive for short distances (less than four miles) in below-freezing temperatures.

When your vehicle is new, it should be serviced by a Ford dealer service department to protect the factory warranty. In many cases, the initial maintenance check is done at no cost to the owner. Note that this first free service (carried out by the selling dealer

1500 miles or 3 months after delivery), although an important check for a new vehicle, is not part of the regular maintenance schedule, and is therefore not mentioned here.

It should be noted that for the 1992 model year, for all models except RS Turbo, the service time/mileage intervals were extended by the manufacturer to the periods shown in this schedule. Although these intervals can be applied retrospectively, owners of earlier vehicles may notice a discrepancy between this schedule and the one shown in the Service Guide supplied with the vehicle.

### Every 250 miles (400 km) or weekly

- Refer to "Weekly Checks".

### Every 5000 miles (8000 km) or 6 months, whichever occurs first

**Note:** Frequent oil and filter changes are good for the engine. We recommend changing the oil at the mileage specified here, or at least twice a year if the mileage covered is less.

- Renew the engine oil and filter (Section 3).

### Every 10 000 miles (16 000 km) or 12 months, whichever occurs first

Carry out all operations listed above, plus the following:

- Check the auxiliary drivebelt (Section 4).
- Check under the bonnet for fluid leaks and hose condition (Section 5).
- Check the condition of all engine compartment wiring (Section 6).
- Check the valve clearance adjustment - HCS engines only (Section 7).
- Check the manual transmission oil level (Section 8).
- Check the engine idle speed and mixture - HCS and CVH engines only, where possible (Section 9).
- Check the steering, suspension and roadwheels (Section 10).
- Check the driveshaft rubber gaiters and CV joints (Section 11).
- Check the exhaust system (Section 12).
- Check the underbody, and all fuel/brake lines (Section 13).
- Check the brake system (Section 14).
- Check the security of all roadwheel nuts (Section 15).
- Check the doors, tailgate and bonnet, and lubricate their hinges and locks (Section 16).
- Check the seat belts (Section 17).
- Check the condition of the bodywork, paint and exterior trim (Section 18).
- Road test (Section 19).
- Check the automatic transmission fluid level (Section 20).

### Every 20 000 miles (32 000 km) or two years, whichever occurs first

Carry out all operations listed above, plus the following:

- Renew the spark plugs and check the condition of the HT leads - all engines except Zetec (Section 21).
- Clean the idle speed control valve (Weber type) - CVH EFI engines only (Section 22).

### Every 30 000 miles (48 000 km) or three years, whichever occurs first

Carry out all operations listed above, plus the following:

- Renew the coolant (Section 23).
- Renew the air cleaner filter element and check the air cleaner temperature control system - carburettor engines only (Section 24).
- Check the emission control systems (Section 25).
- Renew the spark plugs and check the condition of the HT leads - Zetec engines (Section 21).
- Renew the automatic transmission fluid (Section 26).
- Check the handbrake adjustment (Section 27).
- Check the front wheel alignment (Section 28).

**Note:** If the vehicle is used regularly in dusty or polluted conditions, the air cleaner filter element should be renewed at more frequent intervals.

### Every 40 000 miles

- Renew the timing belt - CVH and PTE engines only (Section 29).

### Every 60 000 miles

- Renew the timing belt - Zetec engines only (Section 29).
- Renew the fuel filter (Section 30).

### Every three years (regardless of mileage)

- Renew the brake fluid (Section 31).

## 1.1 litre HCS carburettor engine (air cleaner removed for clarity)

- 1 Engine oil filler cap
- 2 Engine oil level dipstick
- 3 Cooling system expansion tank
- 4 Brake fluid reservoir
- 5 Windscreen/tailgate washer fluid reservoir cap
- 6 Battery
- 7 Vehicle identification plate
- 8 Thermostat housing
- 9 Radiator cooling fan thermal switch multi-plug
- 10 Alternator
- 11 Starter motor solenoid
- 12 CTX automatic transmission fluid level dipstick
- 13 Exhaust heatshield/airbox
- 14 Brake pressure control valves
- 15 Top of suspension strut mounting assembly
- 16 Carburettor
- 17 Fuel feed hose
- 18 Anti-dieselling (fuel-cut off) solenoid connection
- 19 Throttle kicker
- 20 Throttle kicker control solenoid
- 21 Ignition module
- 22 Heater blower motor cover
- 23 Windscreen wiper motor mounting bracket

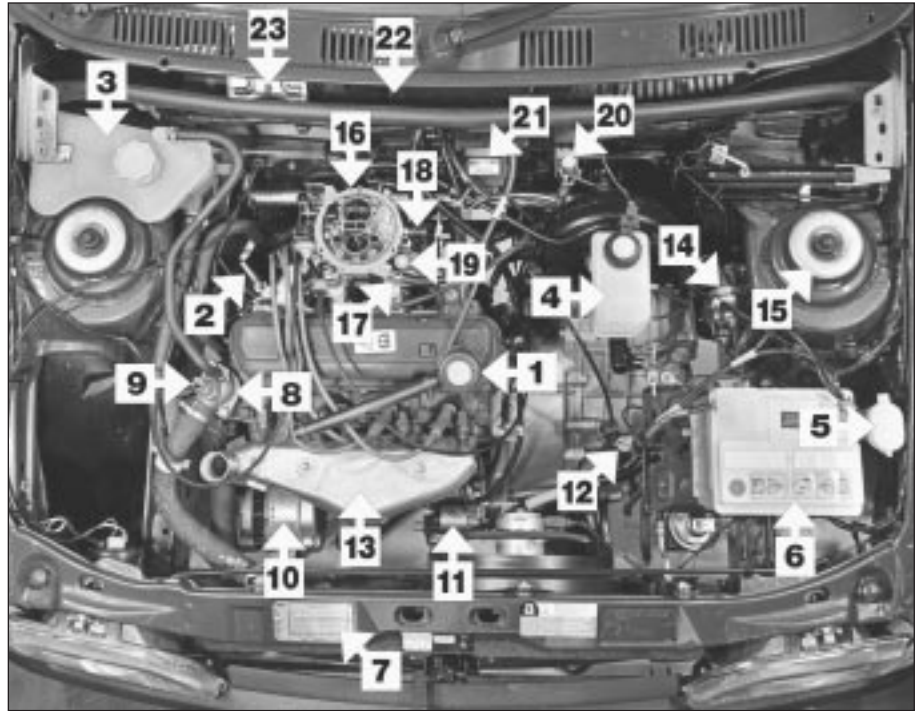

1

## 1.4 litre CVH CFI fuel injection engine (air cleaner removed for clarity)

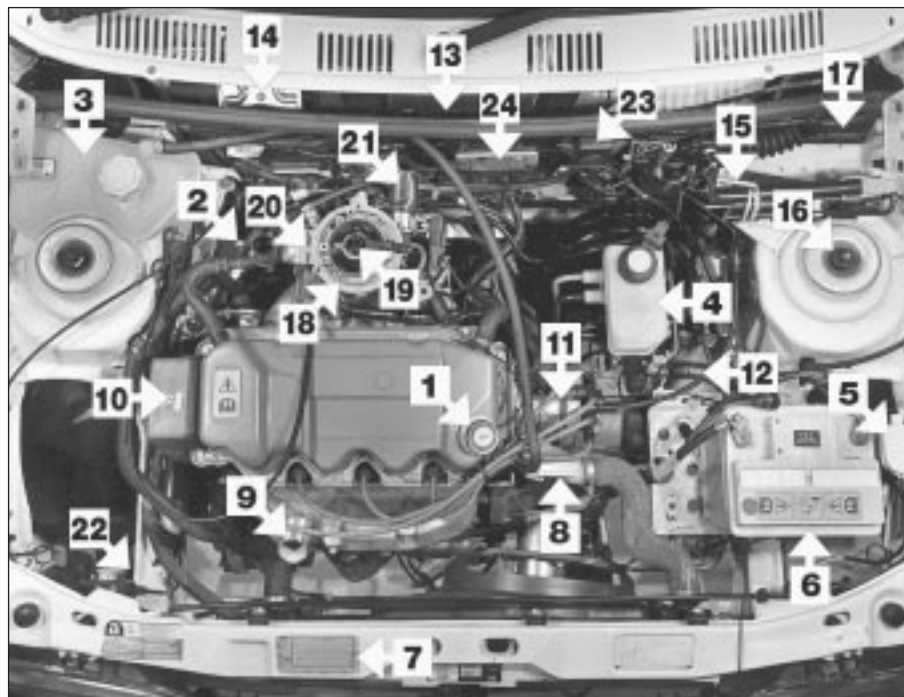

- 1 Engine oil filler cap
- 2 Engine oil level dipstick
- 3 Cooling system expansion tank
- 4 Brake fluid reservoir
- 5 Windscreen/tailgate washer fluid reservoir cap
- 6 Battery
- 7 Vehicle identification plate
- 8 Thermostat housing
- 9 Pre-heat tube
- 10 Timing belt cover
- 11 Distributor
- 12 Fuel filter
- 13 Heater blower motor cover
- 14 Windscreen wiper motor mounting bracket
- 15 Jack and wheelbrace retaining bolt
- 16 Top of suspension strut mounting assembly
- 17 EEC IV engine management module cover
- 18 CFI unit
- 19 Fuel injector
- 20 Fuel pressure regulator
- 21 Throttle plate control motor
- 22 Carbon canister
- 23 Manifold absolute pressure sensor
- 24 Ignition module

## 1.6 Maintenance – component location

### 1.6 litre (XR2i) CVH EFi fuel injection engine

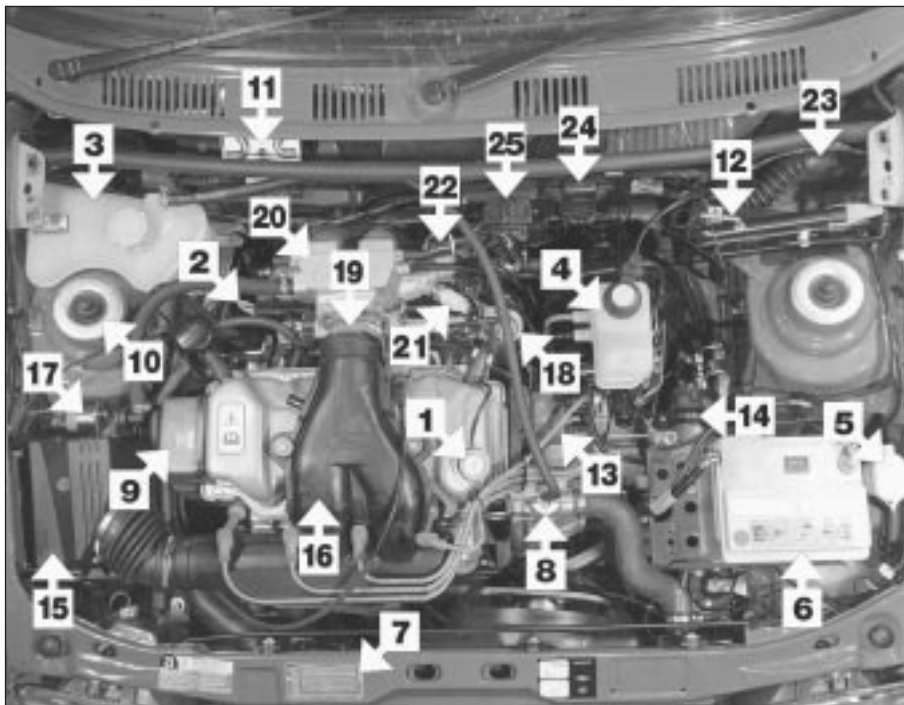

- 1 Engine oil filler cap
- 2 Engine oil level dipstick
- 3 Cooling system expansion tank
- 4 Brake fluid reservoir
- 5 Windscreen/tailgate washer fluid reservoir cap
- 6 Battery
- 7 Vehicle identification plate
- 8 Thermostat housing
- 9 Timing belt cover
- 10 Top of suspension strut mounting assembly
- 11 Windscreen wiper motor mounting bracket
- 12 Jack and wheelbrace retaining bolt
- 13 Distributorless (E-DIS) ignition coil
- 14 Fuel filter
- 15 Air cleaner
- 16 Air inlet duct
- 17 Idle speed control valve
- 18 Fuel pressure regulator
- 19 Throttle housing
- 20 Upper section of inlet manifold
- 21 Intake air temperature sensor
- 22 Fuel trap
- 23 EEC IV engine management module cover
- 24 Manifold absolute pressure sensor
- 25 Ignition module

### 1.8 litre (XR2i) Zetec SEFi fuel injection engine

- 1 Engine oil filler cap
- 2 Engine oil level dipstick
- 3 Cooling system expansion tank
- 4 Braking system fluid reservoir
- 5 Windscreen/tailgate washer fluid reservoir cap
- 6 Battery
- 7 VIN plate
- 8 Thermostat housing
- 9 Timing belt cover
- 10 Top of suspension strut mounting assembly
- 11 Windscreen wiper motor mounting bracket
- 12 Jack and wheelbrace retaining bolt
- 13 Distributorless (E-DIS) ignition coil
- 14 Fuel filter
- 15 Air cleaner
- 16 Air inlet duct
- 17 Idle speed control valve
- 18 Fuel pressure regulator
- 19 Throttle housing
- 20 Inlet manifold
- 21 Throttle position sensor
- 22 Fuel system pressure release/test point
- 23 EEC IV engine management module cover
- 24 Mass air flow sensor
- 25 Ignition module

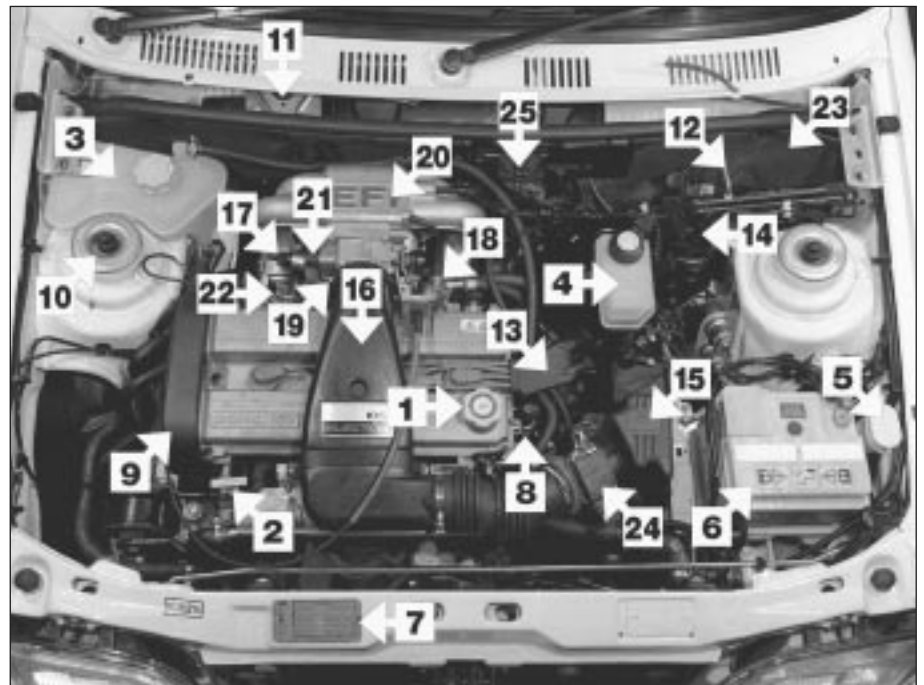

## Front underside view of the 1.4 litre CVH CFi fuel injection model

- 1 Engine oil sump
- 2 Front suspension lower arm
- 3 Brake caliper assembly
- 4 Driveshaft
- 5 Alternator
- 6 Auxiliary drivebelt cover
- 7 Steering rack gaiter
- 8 Windscreen/tailgate washer pump
- 9 Carbon canister
- 10 Oxygen sensor
- 11 Catalytic converter (exhaust) rubber insulator mounting
- 12 Catalytic converter assembly
- 13 Underbody heatshields
- 14 Gearchange mechanism shift rod
- 15 Gearchange mechanism stabiliser bar

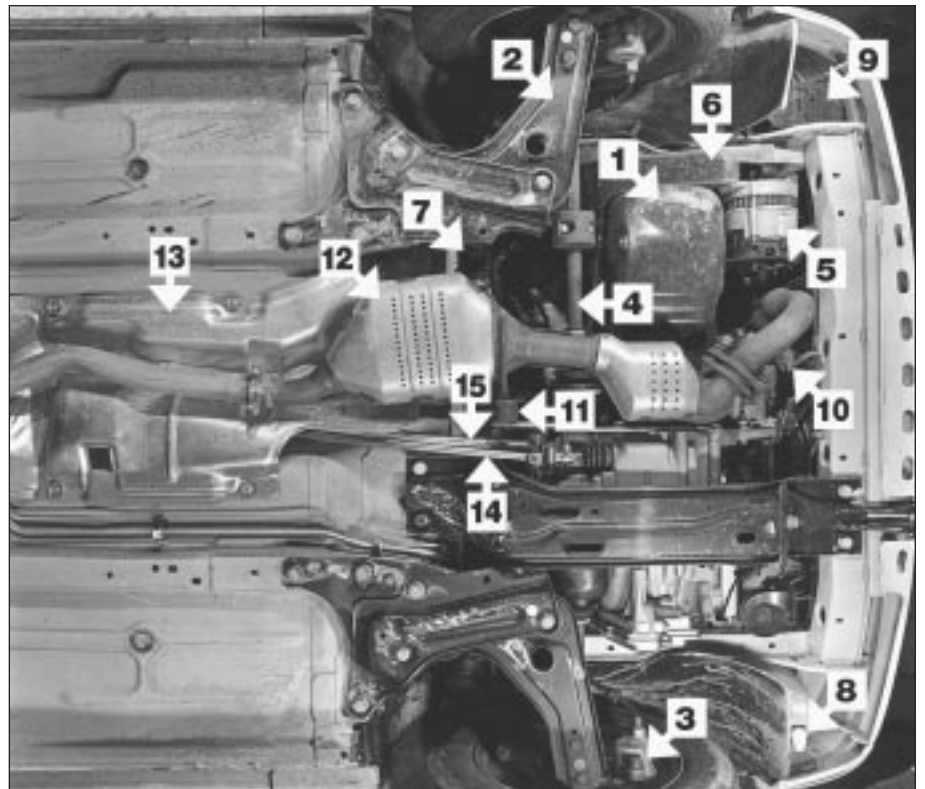

1

## Front underside view of the 1.8 litre (XR2i) Zetec SEFi fuel injection model

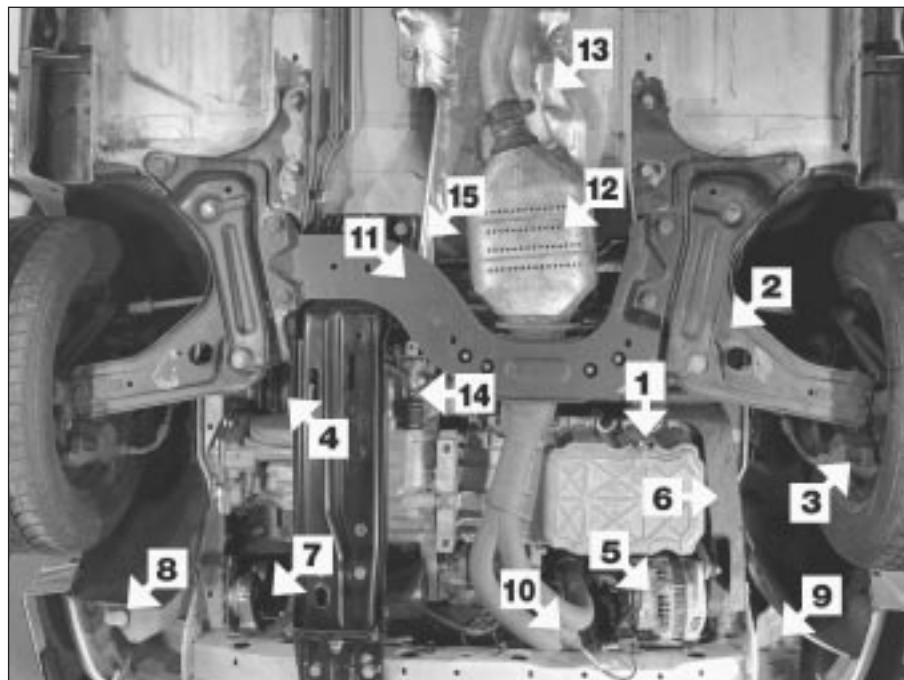

- 1 Engine oil drain plug
- 2 Front suspension lower arm
- 3 Brake caliper assembly
- 4 Driveshaft
- 5 Alternator
- 6 Auxiliary drivebelt cover
- 7 Horn
- 8 Windscreen/tailgate washer pump
- 9 Carbon canister
- 10 Oxygen sensor
- 11 Front suspension crossmember
- 12 Catalytic converter
- 13 Underbody heat shields
- 14 Gearchange mechanism shift rod
- 15 Gearchange mechanism stabiliser bar

## 1.8 Maintenance – component location

### Rear underside view of the 1.4 litre CVH CFI fuel injection model

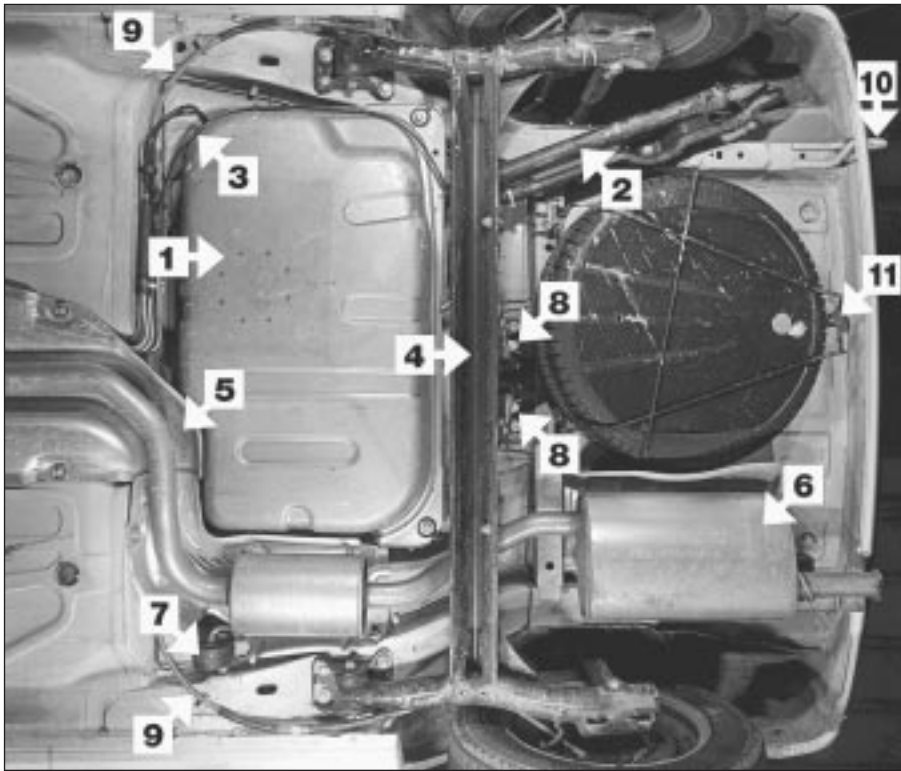

- 1 Fuel tank
- 2 Fuel filler pipe
- 3 Fuel tank ventilation hose
- 4 Twist beam rear axle assembly
- 5 Underbody heatshields
- 6 Exhaust rear silencer
- 7 Exhaust rubber insulator mounting
- 8 Load apportioning valves (on vehicles with the anti-lock braking system)
- 9 Handbrake cable
- 10 Rear towing eye
- 11 Spare wheel carrier hook (on the retaining bolt)

### Rear underside view of the Courier van model

- 1 Fuel tank
- 2 Fuel filler pipe
- 3 Fuel tank ventilation hose
- 4 Rear axle assembly - spring torsion bars visible
- 5 Rear axle pivot brackets
- 6 Rear suspension dampers
- 7 Exhaust system rear silencer
- 8 Braking system light-laden valve
- 9 Handbrake cables
- 10 Rear towing eye
- 11 Spare wheel carrier

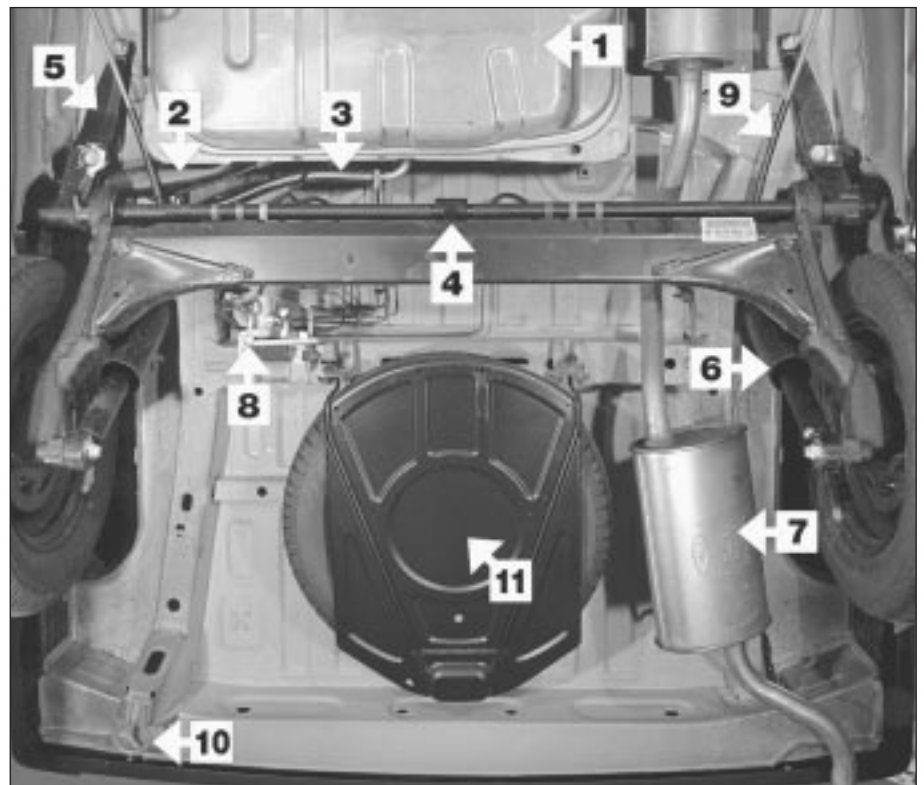



## 1 Introduction

This Chapter is designed to help the home mechanic maintain his/her vehicle for safety, economy, long life and peak performance.

This Chapter contains a master maintenance schedule, followed by Sections dealing specifically with each task in the schedule. Visual checks, adjustments, component renewal and other helpful items are included. Refer to the accompanying illustrations of the engine compartment and the underside of the vehicle for the locations of the various components.

Servicing your vehicle in accordance with the mileage/time maintenance schedule and the following Sections will provide a planned maintenance programme, which should result in a long and reliable service life. This is a comprehensive plan, so maintaining some items but not others at the specified service intervals will not produce the same results.

As you service your vehicle, you will discover that many of the procedures can - and should - be grouped together, because of the particular procedure being performed, or because of the close proximity of two otherwise-unrelated components to one another. For example, if the vehicle is raised for any reason, the exhaust should be inspected at the same time as the suspension and steering components.

The first step of this maintenance programme is to prepare yourself before the actual work begins. Read through all the

Sections relevant to the work to be carried out, then make a list and gather together all the parts and tools required. If a problem is encountered, seek advice from a parts specialist or a dealer service department.

## 2 Intensive maintenance

**1** If, from the time the vehicle is new, the routine maintenance schedule is followed closely, and frequent checks are made of fluid levels and high-wear items, as suggested throughout this manual, the engine will be kept in relatively good running condition, and the need for additional work will be minimised.

**2** It is possible that there will be some times when the engine is running poorly due to the lack of regular maintenance. This is even more likely if a used vehicle, which has not received regular and frequent maintenance checks, is purchased. In such cases, additional work may need to be carried out, outside of the regular maintenance intervals.

**3** If engine wear is suspected, a compression test (refer to Part A, B or C of Chapter 2) will provide valuable information regarding the overall performance of the main internal components. Such a test can be used as a basis to decide on the extent of the work to be carried out. If, for example, a compression test indicates serious internal engine wear, conventional maintenance as described in this Chapter will not greatly improve the performance of the engine, and may prove a

waste of time and money, unless extensive overhaul work (Chapter 2D) is carried out first.

**4** The following series of operations are those often required to improve the performance of a generally poor-running engine:

### Primary operations

- a) Clean, inspect and test the battery (See "Weekly Checks").
- b) Check all the engine-related fluids (See "Weekly Checks").
- c) Check the condition of the auxiliary drivebelt (Section 4).
- d) Check and if necessary adjust the valve clearances on HCS engines (Section 7).
- e) Renew the spark plugs and clean and inspect the HT leads (Section 21).
- f) Check the condition of the air cleaner filter element and renew if necessary (Section 24).
- g) Check and if necessary adjust the idle speed and mixture settings - where applicable (Section 9).
- h) Renew the fuel filter - fuel injection models (Section 30).
- i) Check the condition of all hoses, and check for fluid leaks (Section 5).

**5** If the above operations do not prove fully effective, carry out the following operations:

### Secondary operations

All the items listed under "Primary operations", plus the following:

- a) Check the charging system (Chapter 5A).
- b) Check the ignition system (Chapter 5B).
- c) Check the fuel system (Chapter 4A, 4B, 4C and 4D).
- e) Renew the ignition HT leads (Section 21).

## Every 5000 miles (8000 km) or 6 months, whichever occurs first

### 3 Engine oil and filter renewal



**Frequent oil changes are the best preventive maintenance the home mechanic can give the engine, because ageing oil becomes diluted and contaminated, which leads to premature engine wear.**

**1** Make sure that you have all the necessary tools before you begin this procedure (see illustration). You should also have plenty of rags or newspapers handy, for mopping up any spills.

**2** To avoid any possibility of scalding, and to protect yourself from possible skin irritants and other harmful contaminants in used engine oils, it is advisable to wear gloves when carrying out this work.

**3** Access to the underside of the vehicle is greatly improved if the vehicle can be lifted on a hoist, driven onto ramps, or supported by axle stands (see "Jacking and Vehicle Support").



**Warning: Do not work under a vehicle which is supported only by a hydraulic or scissors-type jack, or by bricks, blocks of wood, etc.**



**3.2** These tools are required when changing the engine oil and filter

**4** If this is your first oil change, get under the vehicle and familiarise yourself with the position of the engine oil drain plug location in the sump. The engine and exhaust components will be warm during the actual work, so try to anticipate any potential problems while the engine and accessories are cool.

**5** The oil should preferably be changed when the engine is still fully warmed-up to normal operating temperature, just after a run (the needle on the temperature gauge should be in the "Normal" sector of the gauge); warm oil and sludge will flow out more easily. Park the vehicle on firm, level ground, apply the handbrake firmly, then select 1st or reverse gear (manual transmission) or the "P" position (automatic transmission). Open the bonnet and remove the engine oil filler cap from the cylinder head cover, then remove the oil level dipstick from its tube (see "Weekly Checks").

**6** Raise the front of the vehicle, and support it securely on axle stands (see "Jacking and Vehicle Support"). Remove the front right-hand roadwheel to provide access to the oil

# 1•10 Every 5000 miles or 6 months



3.7a Engine oil drain plug location in the sump on HCS, CVH and PTE engines



3.7b Removing the engine oil drain plug on the Zetec engine



3.9 Removing the oil filter on the CVH engine using a strap wrench

filter; if the additional working clearance is required, remove also the auxiliary drivebelt cover.

7 Being careful not to touch the hot exhaust components, place the drain pan under the drain plug, and unscrew the plug (see illustrations). If possible, try to keep the plug pressed into the sump while unscrewing it by hand the last couple of turns.



**As the drain plug releases from the threads, move it away sharply, so the stream of oil issuing from the sump runs into the pan, not up your sleeve!**

8 Allow some time for the old oil to drain, noting that it may be necessary to reposition the pan as the oil flow slows to a trickle. Check the condition of the plug's sealing washer and renew it if worn or damaged. When the oil has completely drained, wipe clean the drain plug and its threads in the sump and refit the plug, tightening it to the specified torque wrench setting.

9 Reposition the drain pan under the oil filter then, using a suitable filter removal tool,

unscrew the oil filter from the cylinder block, oil pump or oil filter adaptor, as applicable; be prepared for some oil spillage (see illustration). Check the old filter to make sure that the rubber sealing ring hasn't stuck to the engine; if it has, carefully remove it. Withdraw the filter through the wheel arch, taking care to spill as little oil as possible.

10 Using a clean, lint-free rag, wipe clean the cylinder block around the filter mounting. If there are no specific instructions supplied with it, fit a new oil filter as follows. Apply a light coating of clean engine oil to the filter's sealing ring (see illustration). Screw the filter into position until it seats, then tighten it through a further half- to three-quarters of a turn *only* (see illustration). Tighten the filter by hand only - do not use any tools.

11 Remove the old oil and all tools from under the vehicle, refit the roadwheel, and lower the vehicle to the ground.

12 Refill the engine with oil, using the correct grade and type of oil, as given in "Lubricants, fluids and tyre pressures". Pour in half the specified quantity of oil first, then wait a few minutes for the oil to run to the sump. Continue adding oil a small quantity at a time, until the level is up to the lower notch on the

dipstick. Adding approximately 0.5 to 1.0 litre (depending on model) will raise the level to the dipstick's upper notch.

13 Start the engine. The oil pressure warning light will take a few seconds to go out while the new filter fills with oil; do not race the engine while the light is on. Run the engine for a few minutes, while checking for leaks around the oil filter seal and the drain plug.

14 Switch off the engine, and wait a few minutes for the oil to settle in the sump once more. With the new oil circulated and the filter now completely full, recheck the level on the dipstick, and add more oil as necessary.

15 Dispose of the used engine oil safely, with reference to "General repair procedures" in the Reference Sections of this manual.



**Note: It is antisocial and illegal to dump oil down the drain. To find the location of your local oil recycling bank, call this number free.**



3.10a Lubricate the filter's sealing ring with clean engine oil before installing the filter on the engine



3.10b Fitting the new oil filter on the Zetec engine



4.3 Remove the auxiliary drivebelt lower cover from inside the wheel arch

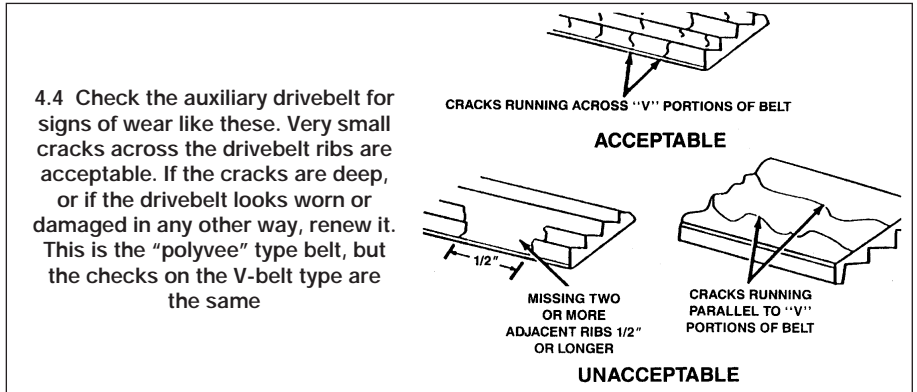

## Every 10 000 miles (16 000 km) or 12 months, whichever comes first

### 4 Auxiliary drivebelt check and renewal



#### General

1 The number of auxiliary drivebelts fitted and their type depends on engine, and on whether the vehicle is equipped with power steering. The drivebelt(s) are located on the right-hand end of the engine and will be either of the V-belt type or the flat, multi-ribbed (or "polyvee") type. The belt drives the alternator, water pump and, on CVH and Zetec engines with power steering, the power steering pump from the engine's crankshaft pulley. On HCS engines with power steering, one belt drives the alternator and water pump and a separate belt drives the power steering pump.

2 The good condition and proper tension of the auxiliary drivebelt is critical to the operation of the engine. Because of their composition and the high stresses to which they are subjected, drivebelts stretch and deteriorate as they get older. They must, therefore, be regularly inspected.

#### Check

3 With the engine switched off, open and support the bonnet, then locate the auxiliary drivebelt(s) on the right-hand end of the engine (*Be very careful, and wear protective gloves to minimise the risk of burning your hands on hot components, if the engine has recently been running*). For improved access, jack up the front right-hand side of the vehicle, support it securely on an axle stand, remove the roadwheel, then (where fitted) remove the auxiliary drivebelt lower cover from inside the wheel arch (see illustration).

4 Using an inspection light or an electric torch, and rotating the engine when necessary with a spanner applied to the crankshaft pulley bolt, check the whole length of the

drivebelt(s) for cracks, separation of the rubber, and torn or worn ribs (see illustration). Also check for fraying and glazing, which gives the drivebelt a shiny appearance. Both sides of the drivebelt(s) should be inspected, which means you will have to twist the drivebelt(s) to check the underside. Feel the relevant drivebelt where you can't see it. If you are in any doubt as to the condition of the drivebelt(s), renewal is necessary (go to paragraph 23).



*Turning the engine will be much easier if the spark plugs are removed first (Section 21).*

#### Drivebelt tension

5 The tension must be adjusted manually on all V-belt type drivebelts, on flat "polyvee" type drivebelts fitted to early Zetec engines, and on "polyvee" type drivebelts fitted to HCS engines to drive the power steering pump. The "polyvee" type drivebelts used on later Zetec engines and PTE engines are fitted with an automatic tensioner to maintain the correct belt adjustment.

6 For models on which the tension can be adjusted manually, open the bonnet. Jack up

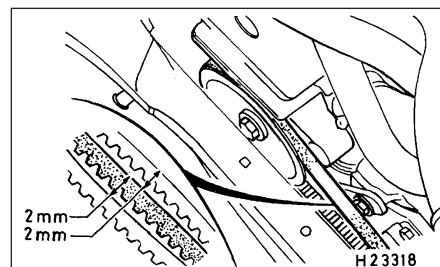

4.7 Checking drivebelt adjustment - V-belt types

*Note that the 4 mm dimension is the total belt swing and is equal to 2 mm of deflection*

the front right-hand side of the vehicle, and support it securely on an axle stand. Remove the roadwheel, then (where fitted) remove the auxiliary drivebelt lower cover from inside the wheel arch.

7 Ford technicians use a special tension gauge and various other special tools for checking drivebelt adjustment, but for DIY purposes, checking the belt tension using finger pressure gives a good indication of correct adjustment. Apply firm finger pressure midway between the pulleys on the longest run of the belt, and look for a deflection of approximately 2.0 mm (i.e. a total drivebelt "swing" of approximately 4.0 mm) (see illustration).

8 If adjustment is necessary, proceed as follows according to belt type.

#### V-belt with sliding arm type adjuster

9 Loosen off the alternator mounting bolts and sliding arm adjustment bolts, pivot the alternator as required to provide the correct drivebelt tension, then retighten the bolts to secure (see illustration).

10 Refit the auxiliary drivebelt cover (where applicable) and roadwheel, then lower the vehicle to the ground.

11 Run the engine for about five minutes, then recheck the tension.

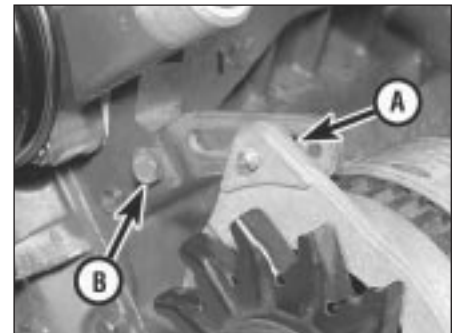

4.9 Alternator sliding arm adjustment bolt (A) and sliding arm mounting bolt (B) - V-belt with sliding arm type adjuster

# 1•12 Every 10 000 miles or 12 months

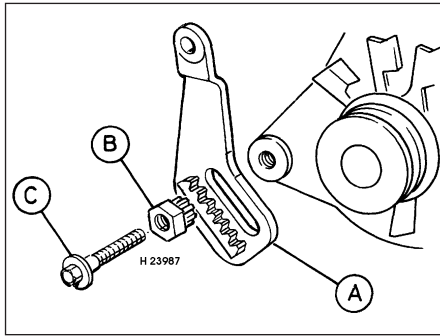

4.12a Rack-and-pinion type auxiliary drivebelt adjuster

- A Adjuster arm
- B Pinion (adjuster) nut
- C Central (locking) bolt

## V-belt and flat "polyvee" type drivebelt with rack-and-pinion type adjuster

12 Loosen off the alternator mounting bolts and the adjusting arm mounting bolt. Slacken the pinion central locking bolt, and turn the pinion nut as required to take up the tension of the drivebelt. Hold it at the required setting, and tighten the central bolt securely to lock the adjuster arm and set the tension (see illustrations).

13 Tighten the alternator mounting and adjusting arm bolts securely.

14 Refit the auxiliary drivebelt cover (where applicable) and roadwheel, then lower the vehicle to the ground.

15 Run the engine for about five minutes, then recheck the tension.

## Flat "polyvee" type drivebelt with tensioner pulley adjuster (HCS engine power steering pump drivebelt)

16 Slacken the tensioner pulley centre bolt then turn the adjuster bolt at the base of the tensioner pulley bracket, as required, to take up the tension of the drivebelt. When the belt deflection is correct, tighten the adjuster pulley centre retaining bolt.

17 Refit the auxiliary drivebelt cover (where applicable) and roadwheel, then lower the vehicle to the ground.

18 Run the engine for about five minutes, then recheck the tension.

## Flat "polyvee" type drivebelt with automatic adjuster

19 As mentioned above, this type of drivebelt is tensioned by an automatic tensioner; regular checks are not required, and manual "adjustment" is not possible.

20 If you suspect that the drivebelt is slipping and/or running slack, or that the tensioner is otherwise faulty, it must be renewed. To do this, remove the drivebelt as described below, then unbolt and remove the tensioner. On fitting the new tensioner, ensure that it is aligned correctly on its mountings, and tightened to the specified torque wrench setting.



4.12b When the tension is correct, hold the adjuster nut, and tighten the central bolt securely to lock the adjuster arm

## Renewal

21 Open the bonnet. Jack up the front right-hand side of the vehicle, and support it securely on an axle stand. Remove the roadwheel, then remove the auxiliary drivebelt lower cover (where fitted) from inside the wheel arch.

22 The routing of the drivebelt around the pulleys is dependent on the drivebelt type, and on whether power steering is fitted. Before removing the drivebelt, it's a good idea to sketch the belt run around the pulleys; this will save a lot of frustration when it comes to refitting. Note that on HCS engines with power steering, to renew the alternator/water pump drivebelt it will be necessary to remove the power steering pump drivebelt first.

23 If the existing drivebelt is to be refitted, mark it, or note the maker's markings on its flat surface, so that it can be installed the same way round.

24 To renew a drivebelt with manual adjustment, slacken the belt tension fully as described above, according to type. Slip the belt off the pulleys, then fit the new belt, ensuring that it is routed correctly. If fitting a flat "polyvee" type drivebelt, arrange it on the grooved pulleys so that it is centred in their grooves, and not overlapping their raised sides. With the belt in position, adjust the tension as previously described.

25 To renew the flat, "polyvee" type drivebelt with automatic adjuster, reach up between the body and the engine (above the crankshaft pulley), and apply a spanner to the hexagon in the centre of the automatic tensioner's pulley. Rotate the tensioner pulley clockwise to release its pressure on the drivebelt, then slip the drivebelt off the crankshaft pulley, and release the tensioner again (see illustration). Note that on certain models, a self-cocking tensioner is fitted, and that this will remain in the released position. Working from the wheel arch or engine compartment as necessary, and noting its routing, slip the drivebelt off the remaining pulleys and withdraw it.

26 Check all the pulleys, ensuring that their grooves are clean, and removing all traces of

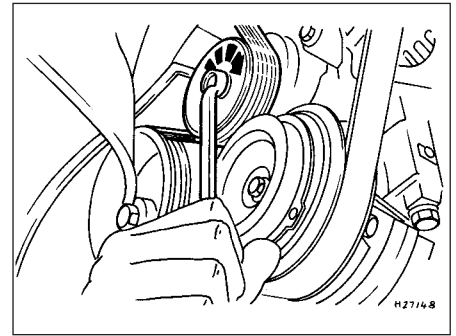

4.25 Automatic drivebelt tensioner - "polyvee" type drivebelt

Turn tensioner clockwise to release tension

oil and grease. Check that the tensioner works properly, with strong spring pressure being felt when its pulley is rotated clockwise, and a smooth return to the limit of its travel when released.

27 If the original drivebelt is being refitted, use the marks or notes made on removal, to ensure that it is installed to run in the same direction as it was previously. To fit the drivebelt, arrange it on the grooved pulleys so that it is centred in their grooves, and not overlapping their raised sides, and is routed correctly. Start at the top, and work down to finish at the crankshaft pulley; rotate the tensioner pulley clockwise, slip the drivebelt onto the crankshaft pulley, then release the tensioner again.

28 Using a spanner applied to the crankshaft pulley bolt, rotate the crankshaft through at least two full turns clockwise to settle the drivebelt on the pulleys, then check that the drivebelt is properly installed.

29 Refit the auxiliary drivebelt cover (where applicable) and roadwheel, then lower the vehicle to the ground.

## 5 Underbonnet check for fluid leaks and hose condition



### General

1 High temperatures in the engine compartment can cause the deterioration of the rubber and plastic hoses used for engine, accessory and emissions systems operation. Periodic inspection should be made for cracks, loose clamps, material hardening and leaks.

2 Carefully check the large top and bottom radiator hoses, along with the other smaller-diameter cooling system hoses and metal pipes; do not forget the heater hoses/pipes which run from the engine to the bulkhead. Inspect each hose along its entire length, replacing any that is cracked, swollen or shows signs of deterioration. Cracks may become more apparent if the hose is

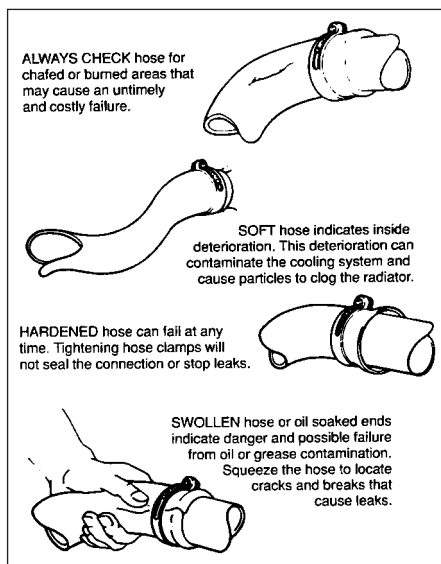

**5.2** Hoses, like drivebelts, have a habit of failing at the worst possible time - to prevent the inconvenience of a blown radiator or heater hose, inspect them carefully as shown here

squeezed (see illustration). If you are using non-Ford specification antifreeze, and so have to renew the coolant every two years or so, it's a good idea to renew the hoses at that time, regardless of their apparent condition.

**3** Make sure that all hose connections are tight. A leak in the cooling system will usually show up as white- or rust-coloured deposits on the areas adjoining the leak; if the spring clamps that are used to secure the hoses in this system appear to be slackening, they should be renewed to prevent the possibility of leaks.

**4** Some other hoses are secured to their fittings with clamps. Where clamps are used, check to be sure they haven't lost their tension, allowing the hose to leak. If clamps aren't used, make sure the hose has not expanded and/or hardened where it slips over the fitting, allowing it to leak.

**5** Check all fluid reservoirs, filler caps, drain plugs and fittings etc, looking for any signs of leakage of oil, transmission and/or brake hydraulic fluid, coolant and power steering fluid. If the vehicle is regularly parked in the same place, close inspection of the ground underneath it will soon show any leaks. As soon as a leak is detected, its source must be traced and rectified. Where oil has been leaking for some time, it is usually necessary to use a steam cleaner, pressure washer or similar, to clean away the accumulated dirt, so that (when the engine is run again) the exact source of the leak can be identified.

## Vacuum hoses

**6** It's quite common for vacuum hoses, especially those in the emissions system, to be colour-coded, or to be identified by coloured

stripes moulded into them. Various systems require hoses with different wall thicknesses, collapse resistance and temperature resistance. When renewing hoses, be sure the new ones are made of the same material.

**7** Often the only effective way to check a hose is to remove it completely from the vehicle. If more than one hose is removed, be sure to label the hoses and fittings to ensure correct installation.

**8** When checking vacuum hoses, be sure to include any plastic T-fittings in the check. Inspect the fittings for cracks, and check the hose where it fits over the fitting for distortion, which could cause leakage.

**9** A small piece of vacuum hose (quarter-inch inside diameter) can be used as a stethoscope to detect vacuum leaks. Hold one end of the hose to your ear, and probe around vacuum hoses and fittings, listening for the "hissing" sound characteristic of a vacuum leak.

**Warning:** When probing with the vacuum-hose stethoscope, be very careful not to come into contact with moving engine components such as the auxiliary drivebelt, radiator electric cooling fan, etc.



## Fuel hoses



**Warning:** There are certain precautions which must be taken when inspecting or servicing fuel system components. Work in a well-ventilated area, and do not allow open flames (cigarettes, appliance pilot lights, etc.) or bare light bulbs near the work area. Mop up any spills immediately, and do not store fuel-soaked rags where they could ignite.

**10** Check all fuel hoses for deterioration and chafing. Check especially for cracks in areas where the hose bends, and also just before fittings, such as where a hose attaches to the fuel filter.

**11** High-quality fuel line, usually identified by the word "Fluoroelastomer" printed on the hose, should be used for fuel line renewal. Never, under any circumstances, use unreinforced vacuum line, clear plastic tubing or water hose for fuel lines.

**12** Spring-type clamps are commonly used on fuel lines. These clamps often lose their tension over a period of time, and can be "sprung" during removal. Replace all spring-type clamps with screw clamps whenever a hose is replaced.

## Metal lines

**13** Sections of metal piping are often used for fuel line between the fuel filter and the engine. Check carefully to be sure the piping has not been bent or crimped, and that cracks have not started in the line.

**14** If a section of metal fuel line must be renewed, only seamless steel piping should be used, since copper and aluminium piping don't have the strength necessary to withstand normal engine vibration.

**15** Check the metal brake lines where they enter the master cylinder and ABS hydraulic unit (if used) for cracks in the lines or loose fittings. Any sign of brake fluid leakage calls for an immediate and thorough inspection of the brake system.

## 6 Engine compartment wiring check



**1** With the vehicle parked on level ground, apply the handbrake firmly and open the bonnet. Using an inspection light or a small electric torch, check all visible wiring within and beneath the engine compartment.

**2** What you are looking for is wiring that is obviously damaged by chafing against sharp edges, or against moving suspension/transmission components and/or the auxiliary drivebelt, by being trapped or crushed between carelessly-refitted components, or melted by being forced into contact with the hot engine castings, coolant pipes, etc. In almost all cases, damage of this sort is caused in the first instance by incorrect routing on reassembly, after previous work has been carried out.

**3** Depending on the extent of the problem, damaged wiring may be repaired by rejoining the break or splicing-in a new length of wire, using solder to ensure a good connection, and remaking the insulation with adhesive insulating tape or heat-shrink tubing, as appropriate. If the damage is extensive, given the implications for the vehicle's future reliability, the best long-term answer may well be to renew that entire section of the loom, however expensive this may appear.

**4** When the actual damage has been repaired, ensure that the wiring loom is re-routed correctly, so that it is clear of other components, and not stretched or kinked, and is secured out of harm's way using the plastic clips, guides and ties provided.

**5** Check all electrical connectors, ensuring that they are clean, securely fastened, and that each is locked by its plastic tabs or wire clip, as appropriate. If any connector shows external signs of corrosion (accumulations of white or green deposits, or streaks of "rust"), or if any is thought to be dirty, it must be unplugged and cleaned using electrical contact cleaner. If the connector pins are severely corroded, the connector must be renewed; note that this may mean the renewal of that entire section of the loom - see your local Ford dealer for details.

**6** If the cleaner completely removes the corrosion to leave the connector in a satisfactory condition, it would be wise to pack the connector with a suitable material which will exclude dirt and moisture, preventing the corrosion from occurring again; a Ford dealer may be able to recommend a suitable product.

**7** Check the condition of the battery

# 1•14 Every 10 000 miles or 12 months

connections - remake the connections or renew the leads if a fault is found. Use the same techniques to ensure that all earth points in the engine compartment provide good electrical contact through clean, metal-to-metal joints, and that all are securely fastened. (In addition to the earth connection at the engine lifting eye, and that from the transmission to the body/battery, there are others in various places, so check carefully).

**8** Refer to Section 21 for details of spark plug (HT) lead checks.

## 7 Valve clearance adjustment



Refer to Chapter 2, Part A.

## 8 Manual transmission oil level check



**1** The manual transmission does not have a dipstick. To check the oil level, raise the vehicle and support it securely on axle stands, making sure that the vehicle is level. On the lower front side of the transmission housing, you will see the filler/level plug. Unscrew and remove it - an Allen key or bit will probably be required (see illustration).

**2** With the plug removed, check the oil level. To do this accurately, make up an oil level check dipstick from a short length of welding rod or similar material. Make a 90° bend in the rod, then mark the downward leg in 5 mm increments. The dipstick is then inserted through the filler plug orifice so that the unmarked leg rests flat on the plug orifice threads, with the marked leg dipped in the oil. Withdraw the dipstick and read off the level of oil.

**3** The oil level must be maintained between 0 and 5 mm below the lower edge of the filler/level plug hole. Top up (if necessary), using fresh transmission oil of the specified type and using a syringe, or a plastic bottle and tube. Refit and tighten the filler/level plug to the specified torque on completion.

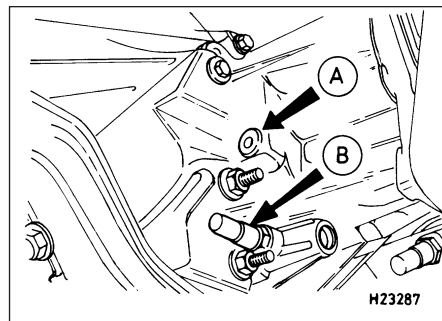

8.1 Manual transmission oil level/filler plug (A), and selector shaft cap nut (B)

**4** The need for regular topping-up can only be due to a leak, which should be found and rectified without delay.

**5** Regular oil changing is not specified by the manufacturer's, but the oil can be drained, if required, by removing the selector shaft cap nut and locking assembly.

## 9 Idle speed and mixture check and adjustment



### General

**1** Many of the engines fitted to Fiesta models are equipped with fuel injection systems of one sort or another which are entirely controlled by the engine management system. On most of these vehicles, it isn't possible to make any adjustments to the idle speed or the mixture settings without specialist test equipment of a type usually only found at a Ford dealer or fuel injection specialist. However, the very nature of these highly-sophisticated systems means they don't go out of tune very often (if ever), so that it's one less maintenance operation to worry about.

**2** On carburettor engines and 1.6 litre EFI fuel injection engines, certain checks and adjustments are necessary as part of the service requirements, and these are described below.

### Idle speed and mixture check and adjustment - carburettor engines

**Note:** Later carburettors are fitted with tamperproof mixture adjusting screws, consisting of a hexagon-shaped socket with a pin in the centre. Such screws require the use of Ford service tool 23-032 to alter their settings; if this tool (or a suitable equivalent) is not available, the CO level will have to be checked, and any necessary adjustment will have to be made, by a Ford dealer.

**3** Before carrying out the following checks and adjustments, ensure that the spark plugs are in good condition and correctly gapped (Section 21). To carry out the

checks/adjustments, an accurate tachometer and an exhaust gas analyser (CO meter) will be required.

**4** Make sure that all electrical components are switched off during the following procedures.

**5** Connect a tachometer to the engine in accordance with its manufacturer's instructions, and insert the probe of an exhaust gas analyser (CO meter) into the exhaust tailpipe. As previously mentioned, these items are essential in obtaining an accurate setting. If they are not available, an approximate check/adjustment can be made as a temporary measure, providing they are further checked out as soon as is possible using a tachometer and a CO meter (or by a Ford dealer).

**6** Run the engine at a fast idle speed until it reaches its normal operating temperature and the radiator cooling fan cuts in. Turn the engine off, then disconnect the radiator cooling fan lead at the thermostatic switch connector. Now connect a temporary wire to the fan switch multi-plug, as shown (see illustration) to enable the fan to operate continuously during the following checks and adjustments (if this is specified). Take care to keep clear of the fan during the following operations when working in the engine compartment.

**7** Where fitted, disconnect the throttle kicker vacuum pipe, and plug the end. To identify the throttle kicker unit, refer to Chapter 4A.

**8** Check that the vehicle lighting and other electrical loadings (apart from the radiator cooling fan) are switched off, then restart the engine. Increase the engine speed to 3000 rpm for 30 seconds, and repeat this at three-minute intervals during the check/adjustment procedures. This will ensure that any excess fuel is cleared from the inlet manifold.

**9** Ensure that the throttle is fully released, allow the meters to stabilise for a period of 5 to 30 seconds is normally sufficient, then check the idle speed against that specified. If adjustment is necessary, turn the idle speed adjusting screw until the engine is idling at the specified speed (see illustrations). Any checks and adjustments must be completed within 30 seconds of the meters stabilising.

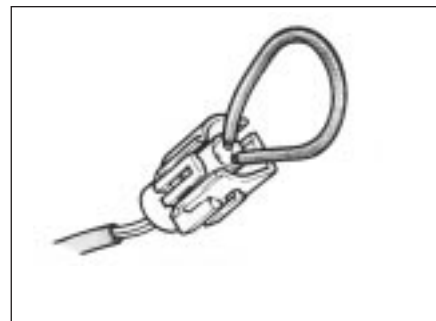

9.6 Cooling fan thermostatic switch multi-plug with temporary bridging wire connected

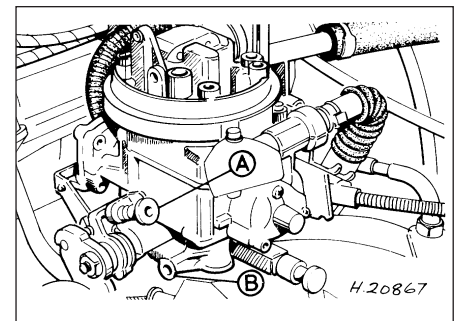

9.9a Idle speed adjusting screw (A) and mixture adjusting screw (B) (Weber TLM carburettor)

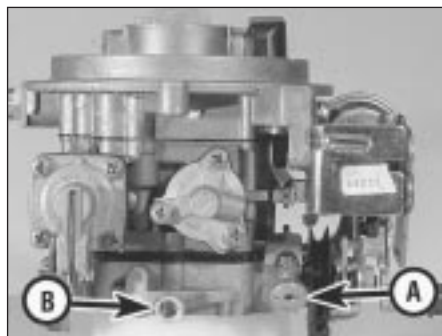

9.9b Idle speed adjusting screw (A) and mixture adjusting screw (B) (Weber TLDM carburettor)

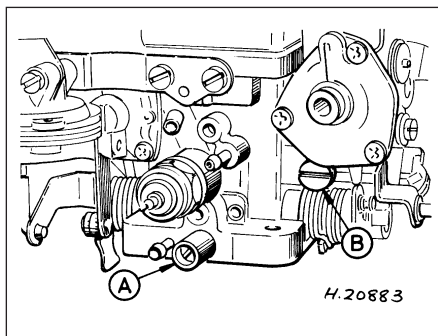

9.9c Idle speed mixture adjusting screw (A) and idle speed adjusting screw (B) (Weber DFTM carburettor)

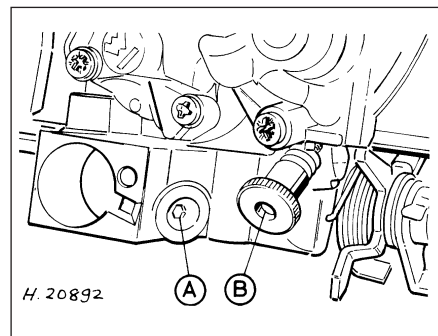

9.9d Idle speed mixture adjusting screw (A) and idle speed adjusting screw (B) (Weber TLD carburettor)

10 If adjustment to the mixture is required, the tamperproof cap will need to be removed from the carburettor to gain access to the mixture screw. To do this, first unclip the fuel trap from the side of the air cleaner unit, then remove the air cleaner unit, ensuring that the crankcase ventilation trap remains connected. Prise free the tamperproof cap (with the aid of a thin-bladed screwdriver), then with the vacuum and emissions control pipes connected to it, relocate the air cleaner unit temporarily into position.

11 Turn the mixture adjustment screw clockwise to weaken the mixture, or anti-clockwise to richen it, until the CO reading is as given in the Specifications. If a CO meter is not being used, weaken the mixture as described, then enrich the mixture

until the maximum engine speed is obtained, consistent with even running.

12 If necessary, re-adjust the idle speed then check the CO reading again. Repeat as necessary until both the idle speed and CO reading are correct.

13 Where required by law (as in some European countries), fit a new tamperproof cap to the mixture adjustment screw.

14 Disconnect the tachometer and the CO meter, refit the air cleaner unit, and reconnect the fan switch lead to complete.

### Base idle speed and mixture check and adjustment - 1.6 litre EFi engines

15 Proceed as described above in paragraphs 3 to 6 inclusive, then continue as follows.

16 Run the engine at a fast idle speed until it reaches its normal operating temperature and the cooling fan cuts in. Check the CO content of the exhaust, and compare it against the specified reading. If the CO content reading is incorrect, it can be adjusted by prising free the tamperproof cap for access to the mixture CO adjustment screw (see illustration), and turning the screw in the required direction to suit.

17 The operational idle speed is controlled by the EEC IV engine management module and is not adjustable. However, if the base idle speed is incorrect, the module will not have an accurate datum point from which to establish

the normal operational idle speed. If idle problems have been experienced, the base idle speed should be checked as follows.

18 Disconnect the multi-plug from the idle speed control valve and increase the engine speed to 2000 rpm, hold it at that speed for 30 seconds, then fully release the throttle and check if the base idle speed registered is as specified.

19 If adjustment is necessary, prise free the tamperproof plug using a suitable small screwdriver to gain access to the base idle speed adjustment screw in the throttle body. Turn the screw in the required direction to adjust the base idle speed to the specified amount. Turning the screw anti-clockwise increases the idle speed (see illustration).

20 Increase the engine speed to 2000 rpm again, hold it at that speed for 30 seconds, then fully release the throttle once more. Check and further adjust the base idle speed if required, then fit a new tamperproof plug into position.

21 Reconnect the idle speed control valve multi-plug and check that the engine speed briefly rises to about 900 rpm, then drops down to the specified normal idle speed.

22 On completion, disconnect the tachometer and the CO meter, but continue running the engine at idle speed for a period of about five minutes, to enable the engine management module to relearn its values before switching it off.



9.16 Adjusting the idle mixture CO content on the 1.6 litre EFi engine

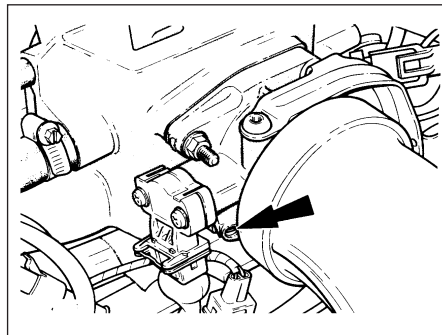

9.19 Base idle speed adjustment screw (arrowed) on the 1.6 litre EFi engine



10.2a Check the condition of the track rod end balljoint dust cover (arrowed)

## 10 Steering, suspension and roadwheel check



### Front suspension and steering check

1 Chock the rear wheels then jack up the front of the car and support it on axle stands (see "Jacking and Vehicle Support").

2 Visually inspect the balljoint dust covers and the steering gear gaiters for splits, chafing or deterioration (see illustrations). Any wear of these components will cause loss of

# 1•16 Every 10 000 miles or 12 months



10.2b Check the condition of the lower arm balljoint dust cover (arrowed)

lubricant, together with dirt and water entry, resulting in rapid deterioration of the balljoints or steering gear.

3 Check the power-assisted steering fluid hoses (where fitted) for chafing or deterioration, and the pipe and hose unions for fluid leaks. Also check for signs of fluid leakage under pressure from the steering gear rubber gaiters, which would indicate failed fluid seals within the steering gear.

4 Grasp the roadwheel at the 12 o'clock and 6 o'clock positions, and try to rock it. Very slight free play may be felt, but if the movement is appreciable, further investigation is necessary to determine the source. Continue rocking the wheel while an assistant depresses the footbrake. If the movement is now eliminated or significantly reduced, it is likely that the hub bearings are at fault. If the free play is still evident with the footbrake depressed, then there is wear in the suspension joints or mountings.

5 Now grasp the wheel at the 9 o'clock and 3 o'clock positions, and try to rock it as before. Any movement felt now may again be caused by wear in the hub bearings or the steering track rod balljoints. If the outer track rod end balljoint is worn, the visual movement will be obvious. If the inner joint is suspect, it can be felt by placing a hand over the rack-and-pinion rubber gaiter, and gripping the track rod. If the wheel is now rocked, movement will be felt at the inner joint if wear has taken place.

6 Using a large screwdriver or flat bar, check for wear in the suspension mounting bushes by levering between the relevant suspension component and its attachment point. Some movement is to be expected, as the mountings are made of rubber, but excessive wear should be obvious. Also check the condition of any visible rubber bushes, looking for splits, cracks or contamination of the rubber.

7 With the vehicle standing on its wheels, have an assistant turn the steering wheel back-and-forth, about an eighth of a turn each way. There should be very little, if any, lost movement between the steering wheel and roadwheels. If this is not the case, closely observe the joints and mountings previously



10.2c Check the condition of the steering rack gaiters

described, but in addition, check the steering column universal joints for wear, and also check the rack-and-pinion steering gear itself.

## Rear suspension check

8 Chock the front wheels then jack up the rear of the car and support it on axle stands (see "Jacking and Vehicle Support"). Remove the rear roadwheels.

9 Check the rear hub bearings for wear, using the method described for the front hub bearings (paragraph 4).

10 Using a large screwdriver or flat bar, check for wear in the suspension mounting bushes by levering between the relevant suspension component and its attachment point. Some movement is to be expected, as the mountings are made of rubber, but excessive wear should be obvious. Check the condition of the shock absorbers and their bushes/mountings. On Van models, check the leaves of the leaf springs for signs of cracking, distortion, or other damage.

## Roadwheel check and balancing

11 Periodically remove the roadwheels, and clean any dirt or mud from the inside and outside surfaces. Examine the wheel rims for signs of rusting, corrosion or other damage. Light alloy wheels are easily damaged by "kerbing" whilst parking, and similarly, steel wheels may become dented or buckled. Renewal of the wheel is very often the only course of remedial action possible.

12 The balance of each wheel and tyre assembly should be maintained, not only to avoid excessive tyre wear, but also to avoid wear in the steering and suspension components. Wheel imbalance is normally signified by vibration through the vehicle's bodyshell, although in many cases it is particularly noticeable through the steering wheel. Conversely, it should be noted that wear or damage in suspension or steering components may cause excessive tyre wear. Out-of-round or out-of-true tyres, damaged wheels and wheel bearing wear/maladjustment also fall into this category. Balancing will not usually cure vibration caused by such wear.

13 Wheel balancing may be carried out with the wheel either on or off the vehicle. If



11.2 Check the driveshaft gaiters by hand for cracks and/or leaking grease

balanced on the vehicle, ensure that the wheel-to-hub relationship is marked in some way prior to subsequent wheel removal, so that it may be refitted in its original position.

## 11 Driveshaft rubber gaiter and CV joint check



1 The driveshaft rubber gaiters are very important, because they prevent dirt, water and foreign material from entering and damaging the constant velocity (CV) joints. External contamination can cause the gaiter material to deteriorate prematurely, so it's a good idea to wash the gaiters with soap and water occasionally.

2 With the vehicle raised and securely supported on axle stands, turn the steering onto full-lock, then slowly rotate each front wheel in turn. Inspect the condition of the outer constant velocity (CV) joint rubber gaiters, squeezing the gaiters to open out the folds. Check for signs of cracking, splits, or deterioration of the rubber, which may allow the escape of grease, and lead to the ingress of water and grit into the joint (see **illustration**). Also check the security and condition of the retaining clips. Repeat these checks on the inner CV joints. If any damage or deterioration is found, the gaiters should be renewed as described in Chapter 8.

3 At the same time, check the general condition of the outer CV joints themselves, by first holding the driveshaft and attempting to rotate the wheels. Any appreciable movement in the CV joint indicates wear in the joint, wear in the driveshaft splines, or a loose driveshaft retaining nut. Repeat this check on the inner joints, by holding the inner joint yoke and attempting to rotate the driveshaft.

## 12 Exhaust system check



1 With the engine cold (at least three hours after the vehicle has been driven), check the complete exhaust system, from its starting



point at the engine to the end of the tailpipe. Ideally, this should be done on a hoist, where unrestricted access is available; if a hoist is not available, raise and support the vehicle on axle stands.

**2** Check the pipes and connections for evidence of leaks, severe corrosion, or damage. Make sure that all brackets and rubber mountings are in good condition, and tight; if any of the mountings are to be renewed, ensure that the replacements are of the correct type (see illustration). Leakage at any of the joints or in other parts of the system will usually show up as a black sooty stain in the vicinity of the leak. **Note:** *Exhaust sealants should not be used on any part of the exhaust system upstream of the catalytic converter - even if the sealant does not contain additives harmful to the converter, pieces of it may break off and foul the element, causing local overheating.*

**3** At the same time, inspect the underside of the body for holes, corrosion, open seams, etc, which may allow exhaust gases to enter the passenger compartment. Seal all body openings with silicone or body putty.

**4** Rattles and other noises can often be traced to the exhaust system, especially the rubber mountings. Try to move the system, silencer(s) and catalytic converter. If any components can touch the body or suspension parts, secure the exhaust system with new mountings.

**5** Check the running condition of the engine by inspecting inside the end of the tailpipe; the exhaust deposits here are an indication of the engine's state of tune. The inside of the tailpipe should be dry, and should vary in colour from dark grey to light grey/brown; if it is black and sooty, or coated with white deposits, the engine is in need of a thorough fuel system inspection.

## 13 Underbody and fuel/brake line check



**1** With the vehicle raised and supported on axle stands or over an inspection pit, thoroughly inspect the underbody and wheel arches for signs of damage and corrosion. In particular, examine the bottom of the side sills, and any concealed areas where mud can collect. Where corrosion and rust is evident, press and tap firmly on the panel with a screwdriver, and check for any serious corrosion which would necessitate repairs. If the panel is not seriously corroded, clean away the rust, and apply a new coating of underseal. Refer to Chapter 11 for more details of body repairs.

**2** At the same time, inspect the PVC-coated lower body panels for stone damage and general condition.

**3** Inspect all of the fuel and brake lines on the underbody for damage, rust, corrosion and leakage. Also make sure that they are



**12.2 Ensure that the exhaust system rubber mountings replacements are of the correct type - their colour is a good guide. Those nearest to the catalytic converter are more heat-resistant than the others**

correctly supported in their clips. Where applicable, check the PVC coating on the lines for damage.

## 14 Brake check



**Note:** *For detailed photographs of the brake system, refer to Chapter 9.*

**1** The work described in this Section should be carried out at the specified intervals, or whenever a defect is suspected in the braking system. Any of the following symptoms could indicate a potential brake system defect:

- The vehicle pulls to one side when the brake pedal is depressed.*
- The brakes make scraping or dragging noises when applied.*
- Brake pedal travel is excessive.*
- The brake fluid requires repeated topping-up.*

**2** A thorough inspection should be made to confirm the thickness of the linings, as follows.

### Front brakes

**3** Chock the rear wheels then jack up the front of the car and support it on axle stands (see "Jacking and Vehicle Support").

**4** For better access to the brake calipers, remove the wheels.

**5** Look through the inspection window in the caliper, and check that the thickness of the friction lining material on each of the pads is not less than the recommended minimum thickness given in the Specifications. **Note:** *Bear in mind that the lining material is normally bonded to a metal backing plate.*

**6** If it is difficult to determine the exact thickness of the pad linings, or if you are at all concerned about the condition of the pads, then remove them from the calipers for further inspection (refer to Chapter 9).

**7** Check the remaining brake caliper in the same way.

**8** If any one of the brake pads has worn down

to, or below, the specified limit, *all four* pads must be renewed as a set.

**9** Measure the thickness of the discs with a micrometer, if available, to make sure that they still have service life remaining. If any disc is thinner than the specified minimum thickness, renew it (refer to Chapter 9). In any case, check the general condition of the discs. Look for excessive scoring and discolouration caused by overheating. If these conditions exist, remove the relevant disc and have it resurfaced or renewed (refer to Chapter 9).

**10** Before refitting the wheels and lowering the car, check all brake lines and hoses (refer to Chapter 9). In particular, check the flexible hoses in the vicinity of the calipers, where they are subjected to most movement. Bend them between the fingers (but do not actually bend them double, or the casing may be damaged) and check that this does not reveal previously-hidden cracks, cuts or splits.

### Rear brakes

**11** Chock the front wheels then jack up the rear of the car and support it on axle stands (see "Jacking and Vehicle Support").

**12** For better access, remove the rear wheels.

**13** To check the brake shoe lining thickness without removing the brake drums, prise the rubber plugs from the backplates, and use an electric torch and mirror to inspect the linings of the leading brake shoes. Check that the thickness of the lining material on the brake shoes is not less than the recommendation given in the Specifications.

**14** If it is difficult to determine the exact thickness of the brake shoe linings, or if you are at all concerned about the condition of the shoes, then remove the rear drums for a more comprehensive inspection (refer to Chapter 9).

**15** With the drum removed, check the shoe return and hold-down springs for correct installation, and check the wheel cylinders for leakage of brake fluid. Check the friction surface of the brake drums for scoring and discoloration. If excessive, the drum should be resurfaced or renewed.

**16** Before refitting the wheels, check all brake lines and hoses (refer to Chapter 9). On completion, apply the handbrake and check that the rear wheels are locked. The handbrake also requires periodic adjustment, and if its travel seems excessive, refer to Section 27.

## 15 Roadwheel nut tightness check



**1** Apply the handbrake.

**2** Remove the wheel covers, using the flat end of the wheelbrace supplied in the tool kit (on some models it will be necessary to unscrew the retaining bolts with a special key).

# 1.18 Every 10 000 miles or 12 months

- 3 Check that the roadwheel nuts are tightened to the specified torque wrench setting.
- 4 Refit the wheel covers.

## 16 Door, tailgate and bonnet check and lubrication



- 1 Check that the doors and tailgate/boot lid close securely. Check that the bonnet safety catch operates correctly. Check the operation of the door check straps.
- 2 Lubricate the hinges, door check straps, the striker plates and the bonnet catch sparingly with a little oil or grease.

## 17 Seat belt check



- 1 Check the seat belts for satisfactory operation and condition. Inspect the webbing for fraying and cuts. Check that they retract smoothly and without binding into their reels.
- 2 Check that the seat belt mounting bolts are tight, and if necessary tighten them to the specified torque wrench settings as given in Chapter 11.

## 18 Bodywork, paint and exterior trim check



- 1 The best time to carry out this check is after the car has been washed so that any surface blemish or scratch will be clearly evident and not hidden by a film of dirt.
- 2 Starting at one front corner check the paintwork all around the car, looking for minor scratches or more serious dents. Check all the trim and make sure that it is securely attached over its entire length.
- 3 Check the security of all door locks, door mirrors, badges, bumpers, front grille and wheel trim. Anything found loose, or in need of further attention should be done with reference to the relevant Chapters of this manual.
- 4 Rectify any problems noticed with the paintwork or body panels as described in Chapter 11.

## 19 Road test



### Check the operation and performance of the braking system

- 1 Make sure that the vehicle does not pull to one side when braking, and that the wheels do not lock prematurely when braking hard.
- 2 Check that there is no vibration through the steering when braking.

- 3 Check that the handbrake operates correctly, without excessive movement of the lever, and that it holds the vehicle stationary on a slope.

- 4 Test the operation of the brake servo unit as follows. With the engine switched off, depress the footbrake four or five times to exhaust the vacuum, then hold the pedal depressed. Start the engine, and there should be a noticeable "give" in the brake pedal as vacuum builds up. Allow the engine to run for at least two minutes, and then switch it off. If the brake pedal is depressed again, it should be possible to detect a hiss from the servo as the pedal is depressed. After about four or five applications, no further hissing should be heard, and the pedal should feel considerably firmer.

### Steering and suspension

- 5 Check for any abnormalities in the steering, suspension, handling or road "feel".
- 6 Drive the vehicle, and check that there are no unusual vibrations or noises.
- 7 Check that the steering feels positive, with no excessive sloppiness or roughness, and check for any suspension noises when cornering and driving over bumps.

### Drivetrain

- 8 Check the performance of the engine, transmission and driveshafts.
- 9 Check that the engine starts correctly, both when cold and when hot.
- 10 Listen for any unusual noises from the engine and transmission.
- 11 Make sure that the engine runs smoothly when idling, and that there is no hesitation when accelerating.
- 12 On manual transmission models, check that all gears can be engaged smoothly without noise, and that the gear lever action is not abnormally vague or "notchy".
- 13 On automatic transmission models, make sure that the drive seems smooth without jerks or engine speed "flare-ups". Check that all the gear positions can be selected with the vehicle at rest. If any problems are found, they should be referred to a Ford dealer.
- 14 Listen for a metallic clicking sound from the front of the vehicle, as the vehicle is driven slowly in a circle with the steering on full-lock. Carry out this check in both directions. If a clicking noise is heard, this indicates wear in a driveshaft joint, in which case renew the joint if necessary.

### Clutch

- 15 Check that the clutch pedal moves smoothly and easily through its full travel, and that the clutch itself functions correctly, with no trace of slip or drag. If the movement is uneven or stiff in places, check that the cable is routed correctly, with no sharp turns.
- 16 Inspect both ends of the clutch inner cable, both at the transmission end and inside the car, for signs of wear and fraying.

## Instruments and electrical equipment

- 17 Check the operation of all instruments and electrical equipment.
- 18 Make sure that all instruments read correctly, and switch on all electrical equipment in turn, to check that it functions properly.

## 20 Automatic transmission fluid level check



- 1 The level of the automatic transmission fluid should be carefully maintained. Low fluid level can lead to slipping or loss of drive, while overfilling can cause foaming, loss of fluid and transmission damage.

- 2 The transmission fluid level should only be checked when the transmission is hot (at its normal operating temperature). If the vehicle has just been driven over 10 miles (15 miles in a cold climate), and the fluid temperature is 60 to 70°C, the transmission is hot.

**Caution: If the vehicle has just been driven for a long time at high speed or in city traffic in hot weather, or if it has been pulling a trailer, an accurate fluid level reading cannot be obtained. In these circumstances, allow the fluid to cool down for about 30 minutes.**

- 3 Park the vehicle on level ground, apply the handbrake, and start the engine. While the engine is idling, depress the brake pedal and move the selector lever through all the gear positions three times, beginning and ending in "P".

- 4 Allow the engine to idle for one minute, then (with the engine still idling) remove the dipstick from its tube. Note the condition and colour of the fluid on the dipstick.

- 5 Wipe the fluid from the dipstick with a clean rag, and re-insert it into the filler tube until the cap seats.

- 6 Pull the dipstick out again, and note the fluid level. The level should be between the "MIN" and "MAX" marks. If the level is on the "MIN" mark, stop the engine, and add the specified automatic transmission fluid through the dipstick tube, using a clean funnel if necessary. It is important not to introduce dirt into the transmission when topping-up.

- 7 Add the fluid a little at a time, and keep checking the level as previously described until it is correct. The difference between the "MIN" and "MAX" marks on the dipstick is approximately 0.4 litres.

- 8 The need for regular topping-up of the transmission fluid indicates a leak, which should be found and rectified without delay.

- 9 The condition of the fluid should also be checked along with the level. If the fluid on the dipstick is black or a dark reddish-brown colour, or if it has a burned smell, the fluid should be changed. If you are in doubt about the condition of the fluid, purchase some new fluid, and compare the two for colour and smell.

## Every 20 000 miles (32 000 km) or two years, whichever comes first

### 21 Spark plug renewal and HT component check



**Note:** Spark plug renewal at this service interval is only necessary on the HCS, CVH and PTE engines. On Zetec engines, the recommended interval for spark plug renewal is every 30 000 miles or three years.

#### Spark plug check and renewal

1 It is vital for the correct running, full performance and proper economy of the engine that the spark plugs perform with maximum efficiency. The most important factor in ensuring this is that the plugs fitted are appropriate for the engine. The suitable type is given in the Specifications Section at the beginning of this Chapter, on the Vehicle Emissions Control Information (VECI) label located on the underside of the bonnet (only on models sold in some areas) or in the vehicle's Owner's Handbook. If the correct type is used and the engine is in good condition, the spark plugs should not need attention between scheduled renewal intervals. Spark plug cleaning is rarely necessary, and should not be attempted unless specialised equipment is available, as damage can easily be caused to the firing ends.

2 Spark plug removal and refitting requires a spark plug socket, with an extension which can be turned by a ratchet handle or similar. This socket is lined with a rubber sleeve, to protect the porcelain insulator of the spark plug, and to hold the plug while you insert it into the spark plug hole. You will also need a set of feeler gauges, to check the spark plug electrode gap, and a torque wrench to tighten the new plugs to the specified torque (see illustration).

3 To remove the spark plugs, first open the bonnet; the plugs are easily reached at the top of the engine. Note how the spark plug (HT) leads are routed and secured by clips, and on some engines, how they're positioned along the channel in the cylinder head cover. To prevent the possibility of mixing up spark plug (HT) leads, it is a good idea to try to work on one spark plug at a time.

4 If the marks on the original-equipment spark plug (HT) leads cannot be seen, mark the leads 1 to 4, to correspond to the cylinder the lead serves (No 1 cylinder is at the timing belt/chain end of the engine). Pull the leads from the plugs by gripping the rubber boot, not the lead, otherwise the lead connection may be fractured.

5 It is advisable to soak up any liquid in the spark plug recesses with a rag, and to remove any dirt from them using a clean brush, vacuum cleaner or compressed air before removing the plugs, to prevent any dirt or water from dropping into the cylinders.



**Warning:** Wear eye protection when using compressed air!

6 Unscrew the spark plugs, ensuring that the socket is kept in alignment with each plug - if the socket is forcibly moved to either side, the porcelain top of the plug may be broken off. If any undue difficulty is encountered when unscrewing any of the spark plugs, carefully check the cylinder head threads and tapered sealing surfaces for signs of wear, excessive corrosion or damage; if any of these conditions is found, seek the advice of a Ford dealer as to the best method of repair.

7 As each plug is removed, examine it as follows - this will give a good indication of the condition of the engine. If the insulator nose is covered with light tan to greyish-brown deposits, then the mixture is correct, and it is likely that the engine is in good condition.

8 If the tip and insulator nose are covered with hard black-looking deposits, then this is indicative that the mixture is too rich. Should the plug be black and oily, then it is likely that the engine is fairly worn, as well as the mixture being too rich.

9 If the insulator nose of the spark plug is

clean and white, with no deposits, this is indicative of a weak mixture.

10 If you are renewing the spark plugs, purchase the new plugs, then check each of them first for faults such as cracked insulators or damaged threads. Note also that, whenever the spark plugs are renewed as a routine service operation, the spark plug (HT) leads should be checked as described below.

11 The spark plug electrode gap is of considerable importance as, if it is too large or too small, the size of the spark and its efficiency will be seriously impaired. The gap should be set to the value given in the Specifications Section of this Chapter. New plugs will not necessarily be set to the correct gap, so they should always be checked before fitting.

12 The spark plug gap is correct when the correct-size feeler gauge or wire gauge is a firm sliding fit between the electrodes (see illustrations).

13 To adjust the electrode gap, bend open, or close up, the outer plug electrode until the correct gap is achieved (see illustration). The centre electrode should never be bent, as this may crack the insulation and cause plug failure,



21.2 Tools required for changing spark plugs



21.12a Measuring a spark plug gap with a feeler gauge



21.12b Spark plug manufacturers recommend using a wire-type gauge when checking the gap - if the wire or feeler gauge does not slide between the electrodes with a slight drag, adjustment is required



21.13 To change the gap, bend the outer electrode only, and be very careful not to crack or chip the porcelain insulator surrounding the centre electrode

if nothing worse. If the outer electrode is not exactly over the centre electrode, bend it gently to align them. Special spark plug gap adjusting tools are available from motor accessory shops, or from certain spark plug manufacturers.

**14** Before fitting the spark plugs, check that the threaded connector sleeves at the top of the plugs are tight, and that the plug exterior surfaces and threads are clean. Brown staining on the porcelain, immediately above the metal body, is quite normal, and does not necessarily indicate a "leak" between the body and insulator.

**15** Apply a smear of copper-based grease or anti-seize compound to the threads of each plug, and screw them in by hand where possible. Take extra care to enter the plug threads correctly, as the cylinder head is of aluminium alloy.

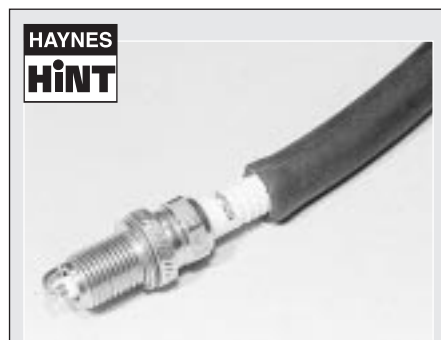

**HAYNES HINT**  
*It's often difficult to insert spark plugs into their holes without cross-threading them. To avoid this possibility, fit a short piece of rubber hose over the end of the spark plug. The flexible hose acts as a universal joint, to help align the plug with the plug hole. Should the plug begin to cross-thread, the hose will slip on the spark plug, preventing thread damage.*

**16** When each spark plug is started correctly on its threads, screw it down until it just seats lightly, then tighten it to the specified torque wrench setting. If a torque wrench is not available - and this is one case where the use of a torque wrench is strongly recommended - tighten each spark plug through *no more than* 1/4 of a turn (CVH and PTE engines) or 1/16 of a turn (HCS and Zetec engines) after it seats. HCS and Zetec engines are fitted with taper-seat spark plugs, identifiable by not having a sealing washer, and these in particular should **NEVER** be overtightened - their tapered seats mean they are almost impossible to remove if abused.

**17** Reconnect the spark plug (HT) leads in their correct order, using a twisting motion on the boot until it is firmly seated on the end of the spark plug and on the cylinder head cover.

**Spark plug (HT) lead, distributor cap and rotor arm check**

**18** The spark plug (HT) leads should be checked whenever the plugs themselves are

renewed. Start by making a visual check of the leads while the engine is running. In a darkened garage (make sure there is ventilation) start the engine and observe each lead. Be careful not to come into contact with any moving engine parts. If there is a break in the lead, you will see arcing or a small spark at the damaged area.

**19** The spark plug (HT) leads should be inspected one at a time, to prevent mixing up the firing order, which is essential for proper engine operation. Each original lead should be numbered to identify its cylinder. If the number is illegible, a piece of tape can be marked with the correct number, and wrapped around the lead (the leads should be numbered 1 to 4, with No 1 lead nearest the timing belt end of the engine). The lead can then be disconnected.

**20** Check inside the boot for corrosion, which will look like a white crusty powder. Clean this off as much as possible; if it is excessive, or if cleaning leaves the metal connector too badly eroded to be fit for further use, the lead must be renewed. Push the lead and boot back onto the end of the spark plug. The boot should fit tightly onto the end of the plug - if it doesn't, remove the lead and use pliers carefully to crimp the metal connector inside the boot until the fit is snug.

**21** Using a clean rag, wipe the entire length of the lead to remove built-up dirt and grease. Once the lead is clean, check for burns, cracks and other damage. Do not bend the lead sharply, because the conductor might break.

**22** Disconnect the lead from the ignition coil by pressing together the plastic retaining catches (where fitted) and pulling the end fitting off the coil terminal. Check for corrosion and for a tight fit. If a meter with the correct measuring range is available, measure the resistance of the disconnected lead from its coil connector to its spark plug connector. If the resistance recorded for any of the leads exceeds the value specified, all the leads should be renewed as a set. Refit the lead to the coil, noting that each coil terminal is marked with its respective cylinder number, so that there is no risk of mixing up the leads and upsetting the firing order.

**23** Inspect the remaining spark plug (HT) leads, ensuring that each is securely fastened at the distributor cap or ignition coil and spark plug when the check is complete. If any sign of arcing, severe connector corrosion, burns, cracks or other damage is noticed, obtain new spark plug (HT) leads, renewing them as a set. If new spark plug leads are to be fitted, remove and refit them one at a time, to avoid mix-ups in the firing order.



*If new spark plug leads are to be fitted, remove the leads one at a time and fit each new lead in exactly the same position as the old one.*

**24** On models with distributor ignition systems, refer to Chapter 5B and remove the distributor cap then thoroughly clean it inside and out with a dry lint-free rag.

**25** Examine the HT lead segments inside the cap. If they appear badly burned or pitted renew the cap. Also check the carbon brush in the centre of the cap, ensuring that it is free to move and stands proud of its holder. Make sure that there are no sign of cracks or black "tracking" lines running down the inside of the cap, which will also mean renewal if evident.

**26** Inspect the rotor arm checking it for security and also for signs of deterioration as described above.

**27** Refit the cap as described in Chapter 5B on completion.

**22 Idle speed control valve cleaning and maintenance**

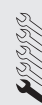

**Note:** *The idle speed control valve may be mounted on the air cleaner, on the engine compartment bulkhead, or on the side of the inlet manifold according to valve make and year of manufacture. Valves manufactured by Weber are mounted on the air cleaner and only these valves require the periodic maintenance described below. Bulkhead and inlet manifold mounted valves are manufactured by Hitachi and are maintenance free. Refer to the warning note in Section 1 of Chapter 4C before proceeding.*

**1** Remove the valve as described in Chapter 4C, Section 14.

**2** Immerse the valve head in a suitable container filled with clean petrol, and allow it to soak for approximately three minutes.

**3** Clean the valve bore, slots and piston with petrol, using a suitable lint-free cloth, then gently move the piston up and down in its bore using a small screwdriver (see illustration). Ensure that no cloth particles enter the bore, and do not use the slots to move the piston.

**4** Rinse the valve again with clean petrol, then dry it using an air line (or other source of compressed air).



**Warning:** *Wear eye protection when using compressed air!*

**5** Clean the mating faces of the valve and the air filter housing then refit as described in Chapter 4C, Section 14.

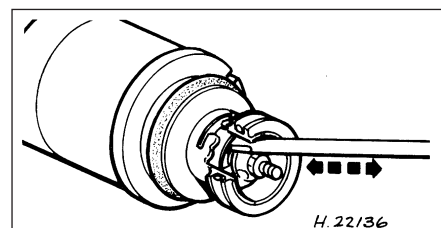

**22.3** Gently move the idle speed control valve piston up and down in its bore using a small screwdriver (1.6 litre EFI engine)