

Fiat Uno Service and Repair Manual

Peter G Strasman

Models covered

(923-320-3Y7)

Fiat Uno 45, 55, 60, 70, 1.1 and 1.4, including Turbo ie and special/limited editions

903 cc, 999 cc, 1108 cc, 1116 cc, 1299 cc, 1301 cc and 1372 cc petrol engines with manual transmissions

Does not Selecta, Fiorino type vans or Diesel engine

© Haynes Publishing 1996

A book in the Haynes Service and Repair Manual Series

All rights reserved. No part of this book may be reproduced or transmitted in any form or by any means, electronic or mechanical, including photocopying, recording or by any information storage or retrieval system, without permission in writing from the copyright holder.

ISBN 1 85960 089 1

British Library Cataloguing in Publication Data

A catalogue record for this book is available from the British Library.

ABCDE
FGHIJ
KLMNO
PQRST
1 2 3

Printed by J H Haynes & Co. Ltd, Sparkford, Nr Yeovil,
Somerset BA22 7JJ

Haynes Publishing
Sparkford, Nr Yeovil, Somerset BA22 7JJ, England

Haynes North America, Inc
861 Lawrence Drive, Newbury Park, California 91320, USA

Editions Haynes S.A.
147/149, rue Saint Honoré, 75001 Paris, France

Haynes Publishing Nordiska AB
Fyrisborgsgatan 5, 754 50 Uppsala, Sverige

Contents

LIVING WITH YOUR FIAT UNO

Introduction	Page	0•4
Safety First!	Page	0•5
General dimensions, weights and capacities	Page	0•6

Roadside Repairs

Jump starting	Page	0•7
Jacking, towing and wheel changing	Page	0•8
Identifying leaks	Page	0•9

Routine Maintenance and Servicing

Maintenance schedule (<i>also see Chapter 13</i>)	Page	0•10
Recommended Lubricants and Fluids	Page	0•13
Conversion factors	Page	0•14

Contents

REPAIRS & OVERHAUL

Engine and Associated Systems

Engine <i>(also see Chapter 13)</i>	Page	1•1
Cooling and heating systems <i>(also see Chapter 13)</i>	Page	2•1
Fuel system <i>(also see Chapter 13)</i>	Page	3•1
Ignition system <i>(also see Chapter 13)</i>	Page	4•1

Transmission

Clutch <i>(also see Chapter 13)</i>	Page	5•1
Transmission <i>(also see Chapter 13)</i>	Page	6•1
Driveshafts, hubs, roadwheels and tyres <i>(also see Chapter 13)</i>	Page	7•1

Brakes

Braking system <i>(also see Chapter 13)</i>	Page	8•1
---	------	-----

Electrical

Electrical system <i>(also see Chapter 13)</i>	Page	9•1
--	------	-----

Steering and suspension

Steering	Page	10•1
Suspension <i>(also see Chapter 13)</i>	Page	11•1

Bodywork

Bodywork <i>(also see Chapter 13)</i>	Page	12•1
---------------------------------------	------	------

Additional information

Supplement: Revisions and information on later models	Page	13•1
---	------	------

Wiring Diagrams

Page 14•1

REFERENCE

MOT Test Checks	Page	REF•1
Tools and Working Facilities	Page	REF•5
General Repair Procedures	Page	REF•8
Fault Finding	Page	REF•9
Buying Spare Parts & Vehicle Identification Numbers	Page	REF•12
Glossary of Technical Terms	Page	REF•13

Index

Page REF•17

Introduction to the Fiat Uno

The Fiat Uno is a well designed and constructed car having an excellent power-to-weight ratio.

The car is very economical, but still offers good performance with excellent body interior space.

Attractive features include the options available for four- or five-speeds or three- or five-door bodywork.

All essential accessories, except a radio, are fitted as standard and a sunroof is optionally available.

From the home mechanic's point of view all repair and servicing operations are straightforward without the need for special tools. Spare parts are immediately available at moderate cost.

Acknowledgements

Thanks are due to Champion Spark Plug who supplied the illustrations showing spark plug conditions. Certain other illustrations are the copyright of the Fiat Motor Company (UK) Limited and are used with their permission. Thanks are also due to Sykes-Pickavant Limited, who provided some of the workshop tools, and to all those people at Sparkford who helped in the production of this manual.

We take great pride in the accuracy of information given in this manual, but vehicle manufacturers make alterations and design changes during the production run of a particular vehicle of which they do not inform us. No liability can be accepted by the authors or publishers for loss, damage or injury caused by any errors in, or omissions from, the information given.



Fiat Uno 1301 cc Turbo ie



Fiat Uno 1372 cc 70 SX ie

Working on your car can be dangerous. This page shows just some of the potential risks and hazards, with the aim of creating a safety-conscious attitude.

General hazards

Scalding

- Don't remove the radiator or expansion tank cap while the engine is hot.
- Engine oil, automatic transmission fluid or power steering fluid may also be dangerously hot if the engine has recently been running.

Burning

- Beware of burns from the exhaust system and from any part of the engine. Brake discs and drums can also be extremely hot immediately after use.

Crushing

- When working under or near a raised vehicle, always supplement the jack with axle stands, or use drive-on ramps.

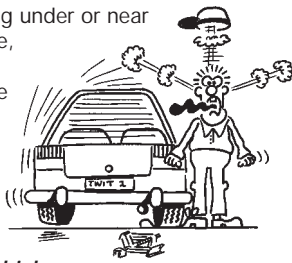

Never venture

under a car which is only supported by a jack.

- Take care if loosening or tightening high-torque nuts when the vehicle is on stands. Initial loosening and final tightening should be done with the wheels on the ground.

Fire

- Fuel is highly flammable; fuel vapour is explosive.
- Don't let fuel spill onto a hot engine.
- Do not smoke or allow naked lights (including pilot lights) anywhere near a vehicle being worked on. Also beware of creating sparks (electrically or by use of tools).
- Fuel vapour is heavier than air, so don't work on the fuel system with the vehicle over an inspection pit.
- Another cause of fire is an electrical overload or short-circuit. Take care when repairing or modifying the vehicle wiring.
- Keep a fire extinguisher handy, of a type suitable for use on fuel and electrical fires.

Electric shock

- Ignition HT voltage can be dangerous, especially to people with heart problems or a pacemaker. Don't work on or near the ignition system with the engine running or the ignition switched on.

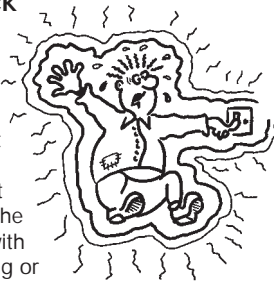

- Mains voltage is also dangerous. Make sure that any mains-operated equipment is correctly earthed. Mains power points should be protected by a residual current device (RCD) circuit breaker.

Fume or gas intoxication

- Exhaust fumes are poisonous; they often contain carbon monoxide, which is rapidly fatal if inhaled. Never run the engine in a confined space such as a garage with the doors shut.
- Fuel vapour is also poisonous, as are the vapours from some cleaning solvents and paint thinners.

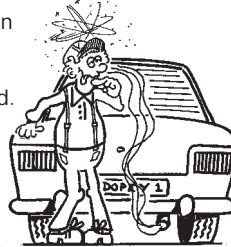

Poisonous or irritant substances

- Avoid skin contact with battery acid and with any fuel, fluid or lubricant, especially antifreeze, brake hydraulic fluid and Diesel fuel. Don't syphon them by mouth. If such a substance is swallowed or gets into the eyes, seek medical advice.
- Prolonged contact with used engine oil can cause skin cancer. Wear gloves or use a barrier cream if necessary. Change out of oil-soaked clothes and do not keep oily rags in your pocket.
- Air conditioning refrigerant forms a poisonous gas if exposed to a naked flame (including a cigarette). It can also cause skin burns on contact.

Asbestos

- Asbestos dust can cause cancer if inhaled or swallowed. Asbestos may be found in gaskets and in brake and clutch linings. When dealing with such components it is safest to assume that they contain asbestos.

Special hazards

Hydrofluoric acid

- This extremely corrosive acid is formed when certain types of synthetic rubber, found in some O-rings, oil seals, fuel hoses etc, are exposed to temperatures above 400°C. The rubber changes into a charred or sticky substance containing the acid. *Once formed, the acid remains dangerous for years. If it gets onto the skin, it may be necessary to amputate the limb concerned.*
- When dealing with a vehicle which has suffered a fire, or with components salvaged from such a vehicle, wear protective gloves and discard them after use.

The battery

- Batteries contain sulphuric acid, which attacks clothing, eyes and skin. Take care when topping-up or carrying the battery.
- The hydrogen gas given off by the battery is highly explosive. Never cause a spark or allow a naked light nearby. Be careful when connecting and disconnecting battery chargers or jump leads.

Air bags

- Air bags can cause injury if they go off accidentally. Take care when removing the steering wheel and/or facia. Special storage instructions may apply.



Warning: Never expose the hands, face or any other part of the body to injector spray; the fuel can penetrate the skin with potentially fatal results.

Remember...

DO

- Do use eye protection when using power tools, and when working under the vehicle.
- Do wear gloves or use barrier cream to protect your hands when necessary.
- Do get someone to check periodically that all is well when working alone on the vehicle.
- Do keep loose clothing and long hair well out of the way of moving mechanical parts.
- Do remove rings, wristwatch etc, before working on the vehicle – especially the electrical system.
- Do ensure that any lifting or jacking equipment has a safe working load rating adequate for the job.

DON'T

- Don't attempt to lift a heavy component which may be beyond your capability – get assistance.
- Don't rush to finish a job, or take unverified short cuts.
- Don't use ill-fitting tools which may slip and cause injury.
- Don't leave tools or parts lying around where someone can trip over them. Mop up oil and fuel spills at once.
- Don't allow children or pets to play in or near a vehicle being worked on.

0.6 General dimensions, weights and capacities

Dimensions

Overall length	3644 mm (143.6 in)
Overall width	1555 mm (61.3 in)
Height	1432 mm (56.4 in)
Wheelbase	2362 mm (93.1 in)
Front track	1340 mm (52.8 in)
Rear track	1300 mm (51.2 in)

Weights (kerb)

Uno 45:	
Three-door	700 kg (1543 lb)
Five-door	710 kg (1566 lb)
Uno 55:	
Three-door	730 kg (1610 lb)
Five-door	740 kg (1632 lb)
Uno 70:	
Three-door	740 kg (1632 lb)
Five-door	750 kg (1654 lb)
Uno SX:	
Three-door	770 kg (1698 lb)
Five-door	780 kg (1720 lb)

Capacities

Fuel tank	42.0 litre (9.25 gal)
Engine oil (with filter change):	
903 cc engine	3.42 litre (6.0 pint)
1116 and 1301 cc engines	4.10 litre (7.2 pint)
Transmission	2.40 litre (4.2 pint)
Steering box	140.0 cc
Driveshaft CV joints	125.0 cc
Cooling system:	
903 cc engine	4.6 litre (8.1 pint)
1116 cc engine	6.0 litre (10.6 pint)
1301 cc engine	6.2 litre (10.9 pint)

For information applicable to later models, see Supplement at end of manual

Jump starting

HAYNES
HINT

Jump starting will get you out of trouble, but you must correct whatever made the battery go flat in the first place. There are three possibilities:

- 1** The battery has been drained by repeated attempts to start, or by leaving the lights on.
- 2** The charging system is not working properly (alternator drivebelt slack or broken, alternator wiring fault or alternator itself faulty).
- 3** The battery itself is at fault (electrolyte low, or battery worn out).

When jump-starting a car using a booster battery, observe the following precautions:

- ✓ Before connecting the booster battery, make sure that the ignition is switched off.
- ✓ Ensure that all electrical equipment (lights, heater, wipers, etc) is switched off.

- ✓ Make sure that the booster battery is the same voltage as the discharged one in the vehicle.
- ✓ If the battery is being jump-started from the battery in another vehicle, the two vehicles **MUST NOT TOUCH** each other.
- ✓ Make sure that the transmission is in neutral (or PARK, in the case of automatic transmission).



1 Connect one end of the red jump lead to the positive (+) terminal of the flat battery



2 Connect the other end of the red lead to the positive (+) terminal of the booster battery.



3 Connect one end of the black jump lead to the negative (-) terminal of the booster battery

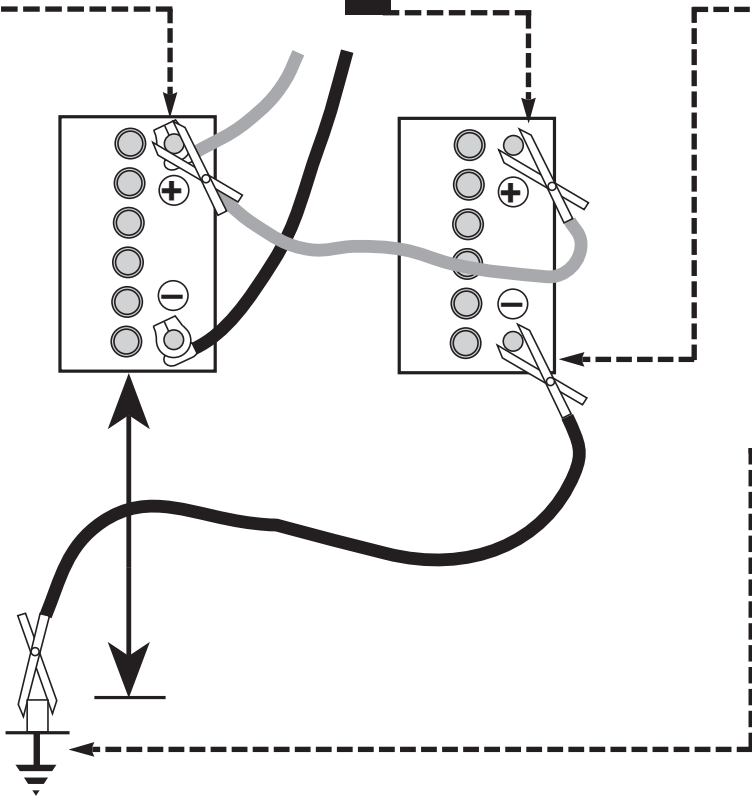

4 Connect the other end of the black jump lead to a bolt or bracket on the engine block, well away from the battery, on the vehicle to be started.

5 Make sure that the jump leads will not come into contact with the fan, drivebelts or other moving parts of the engine.

6 Start the engine using the booster battery, then with the engine running at idle speed, disconnect the jump leads in the reverse order of connection.

Jacking, towing and wheel changing

To avoid repetition, the procedure for raising the vehicle, in order to carry out work under it, is not included before each relevant operation described in this Manual.

It is to be preferred, and it is certainly recommended, that the vehicle is positioned over an inspection pit or raised on a lift. Where these facilities are not available, use ramps or jack up the vehicle strictly in accordance with the following guide. Once the vehicle is raised, supplement the jack with axle stands.

Jacking

The jack supplied with the car should only be used to change a wheel. Do not use this jack when overhaul or repair work is being carried out; employ a hydraulic or screw jack and supplement it with axle stands.

Jacking points are located under the sills for use with the jack supplied.

To raise the front end with a garage jack, locate the jack under the transmission lower mounting, just below and slightly to the rear of the transmission oil drain plug. Protect the mounting by placing a block of wood between the jack head and the mounting.

To raise the rear of the car, the jack should be placed under the spare wheel housing as far to the rear as possible. Place a wooden bearer between the jack head and the housing.

Towing

When being towed, use the left-hand front towing eye.

When towing another vehicle, use the rear towing eye adjacent to the exhaust tailpipe.

When being towed, remember that the brake pedal will require heavier pressure due to lack of servo assistance. Always turn the

ignition key to MAR to retain the steering in the unlocked position.

Wheel changing

With the car on firm level ground, apply the handbrake fully. Remove the hub cap or wheel trim, if fitted.

Release, but do not remove, the bolts. Chock the front and rear of the opposite roadwheel and then raise the car using the sill jack supplied with the car if it is being done at the roadside. Alternatively use a workshop jack supplemented with axle stands.

Remove the wheel bolts, change the wheel and screw in the bolts finger tight. It is recommended that the bolt threads are smeared with multi-purpose grease. Lower the car, remove the jack and tighten the wheel bolts to the specified torque. Refit any wheel trim that was removed.



Spare wheel and jack stowage



Front tow hook

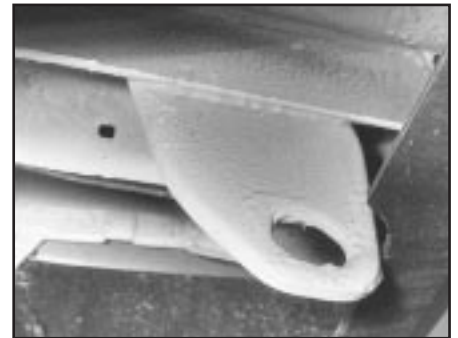

Rear tow hook

Identifying leaks

Puddles on the garage floor or drive, or obvious wetness under the bonnet or underneath the car, suggest a leak that needs investigating. It can sometimes be difficult to decide where the leak is coming from, especially if the engine bay is very dirty already. Leaking oil or fluid can also be blown rearwards by the passage of air under the car, giving a false impression of where the problem lies.



Warning: Most automotive oils and fluids are poisonous. Wash them off skin, and change out of contaminated clothing, without delay.



The smell of a fluid leaking from the car may provide a clue to what's leaking. Some fluids are distinctively coloured. It may help to clean the car and to park it over some clean paper as an aid to locating the source of the leak. Remember that some leaks may only occur while the engine is running.

Sump oil



Engine oil may leak from the drain plug...

Oil from filter



...or from the base of the oil filter.

Gearbox oil



Gearbox oil can leak from the seals at the inboard ends of the driveshafts.

Antifreeze



Leaking antifreeze often leaves a crystalline deposit like this.

Brake fluid



A leak occurring at a wheel is almost certainly brake fluid.

Power steering fluid

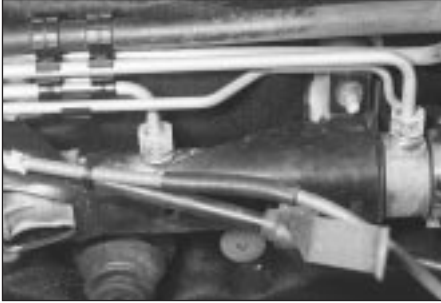

Power steering fluid may leak from the pipe connectors on the steering rack.

Maintenance is essential for ensuring safety and desirable for the purpose of getting the best in terms of performance and economy from the car. Over the years the need for periodic lubrication has been greatly reduced if not totally eliminated. This has unfortunately tended to lead some owners to think that because no such action is required the items either no longer exist or will last forever. This is certainly not the case; it is essential to carry out regular visual examinations as comprehensively as possible in order to spot any possible defects at an early stage before they develop into major and expensive repairs.

For information applicable to later models, see Supplement.

Every 250 miles (400 km), weekly, or before a long journey

- Check engine oil level
- Check brake reservoir fluid level
- Check tyre pressures
- Check operation of all lights and horn
- Top up washer fluid reservoirs, adding a screen wash, and check operation of washers and wipers
- Check coolant level
- Check battery electrolyte level

Every 6000 miles (10 000 km) or six months, whichever comes first

- Renew engine oil and filter (Chapter 1, Section 2)
- Check drivebelt tension (Chapter 2, Section 8)
- Check carburettor idle speed and mixture adjustments (Chapter 3)
- Check contact points and dwell angle (mechanical breaker distributors) (Chapter 4, Section 3)
- Check tyre tread wear (Chapter 7, Section 7)
- Check disc pads for wear (Chapter 8, Section 3)

Every 12 000 miles (20 000 km) or 12 months, whichever comes first

- Check and adjust valve clearances (Chapter 1, Sections 5 and 26)
- Renew air cleaner element (Chapter 3, Section 2)

- Check exhaust system for corrosion (Chapter 3, Section 19)
- Renew contact breaker points and adjust dwell angle (mechanical breaker distributors) (Chapter 4, Section 3)
- Check and adjust ignition timing (Chapter 4, Section 4)
- Renew spark plugs (Chapter 4, Section 11)
- Check clutch adjustment (Chapter 5, Section 2)
- Check transmission oil level (Chapter 6, Section 2)
- Check driveshaft and steering rack gaiters for splits (Chapters 7 and 10)
- Check rear brake shoe linings for wear (Chapter 8, Section 4)
- Check handbrake travel (Chapter 8, Section 16)
- Check headlamp beam alignment (Chapter 9, Section 17)
- Check balljoints for wear (Chapter 10, Section 2)
- Check front wheel alignment (Chapter 10, Section 8)
- Check suspension bushes for wear (Chapter 11, Section 2)
- Check seat belts for fraying (Chapter 12, Section 23)
- Lubricate controls, hinges and locks

Every 24 000 miles (40 000 km) or two years, whichever comes first

- Renew coolant anti-freeze mixture (Chapter 2, Section 3)
- Renew transmission oil (Chapter 6, Section 2)
- Renew brake hydraulic fluid (Chapter 8, Section 12)
- Check for underbody corrosion and clean out door and sill drain holes (Chapter 12, Section 2)

Every 36 000 miles (60 000 km) or three years, whichever comes first

- Renew the timing belt - 1116 and 1299/1301 cc (Chapter 1, Section 28)

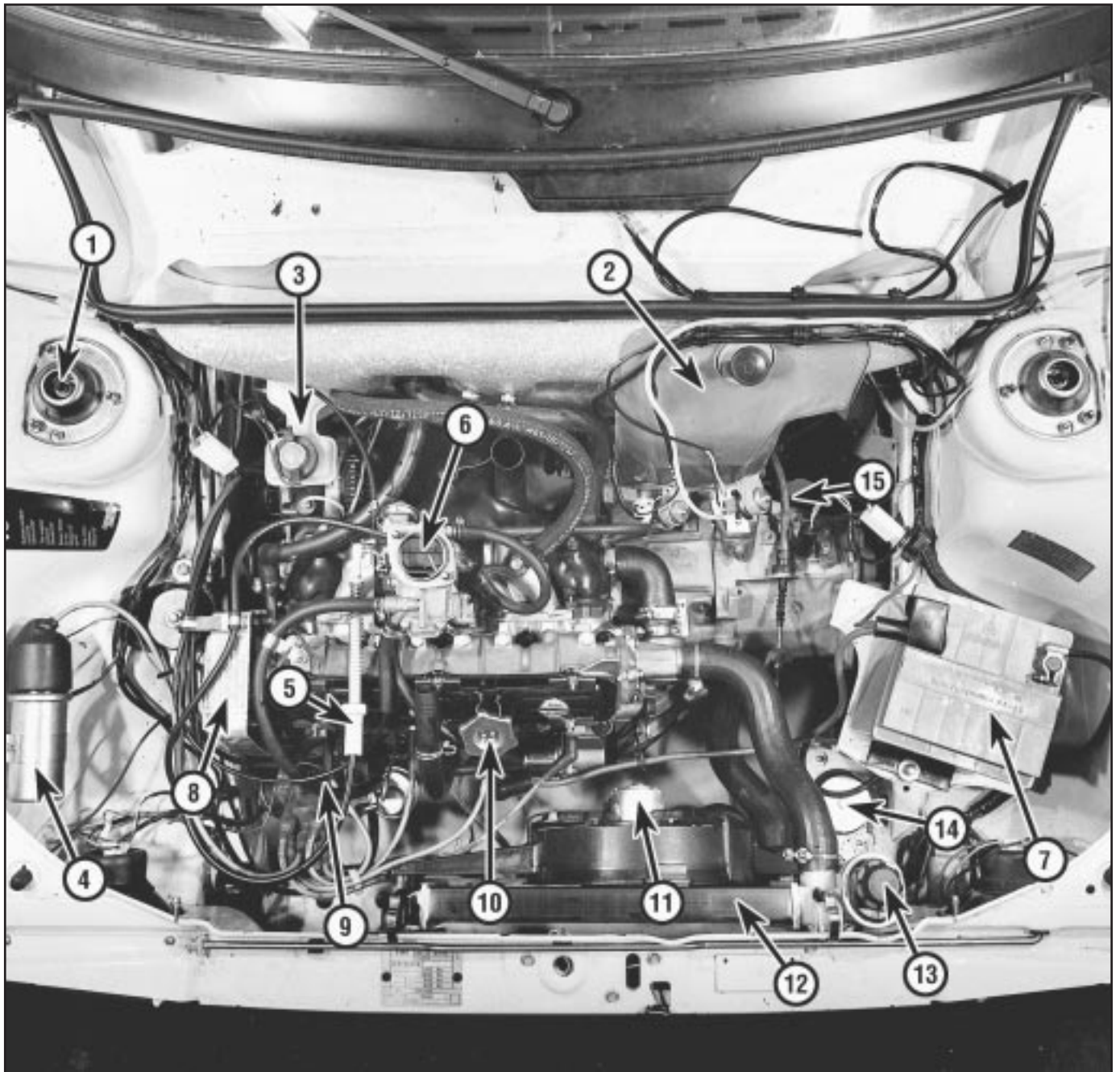

Engine compartment (air cleaner removed for clarity) on 55S model

- | | | | |
|--------------------------|---------------------|----------------------------------|---------------------------|
| 1 Strut upper mounting | 5 Throttle cable | 9 Distributor | 12 Radiator |
| 2 Washer fluid reservoir | 6 Carburettor | 10 Oil filler cap | 13 Coolant expansion tank |
| 3 Brake fluid reservoir | 7 Battery | 11 Radiator electric cooling fan | 14 Front mounting |
| 4 Ignition coil | 8 Timing belt cover | | 15 Clutch operating cable |

0•12 Routine maintenance

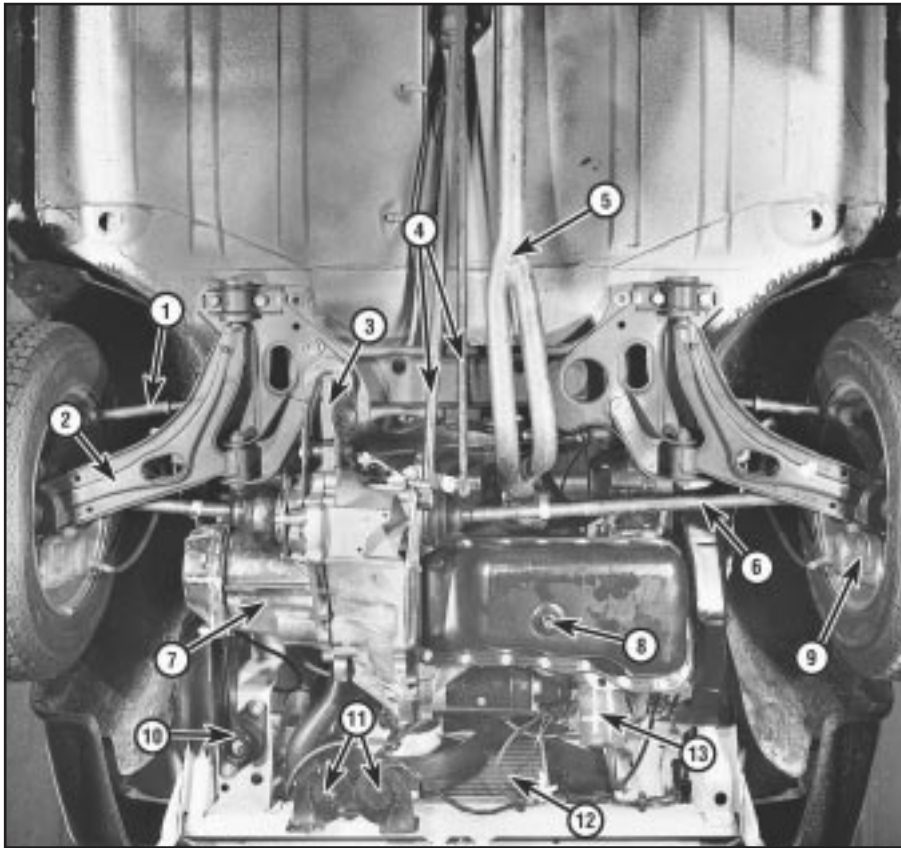

View of front end from below on
55S model

- 1 Tie-rod end
- 2 Track control arm
- 3 Lower mounting
- 4 Gearchange control rods
- 5 Exhaust pipe
- 6 Driveshafts
- 7 Transmission
- 8 Sump drain plug
- 9 Disc caliper
- 10 Front mounting
- 11 Horns
- 12 Radiator
- 13 Oil filter

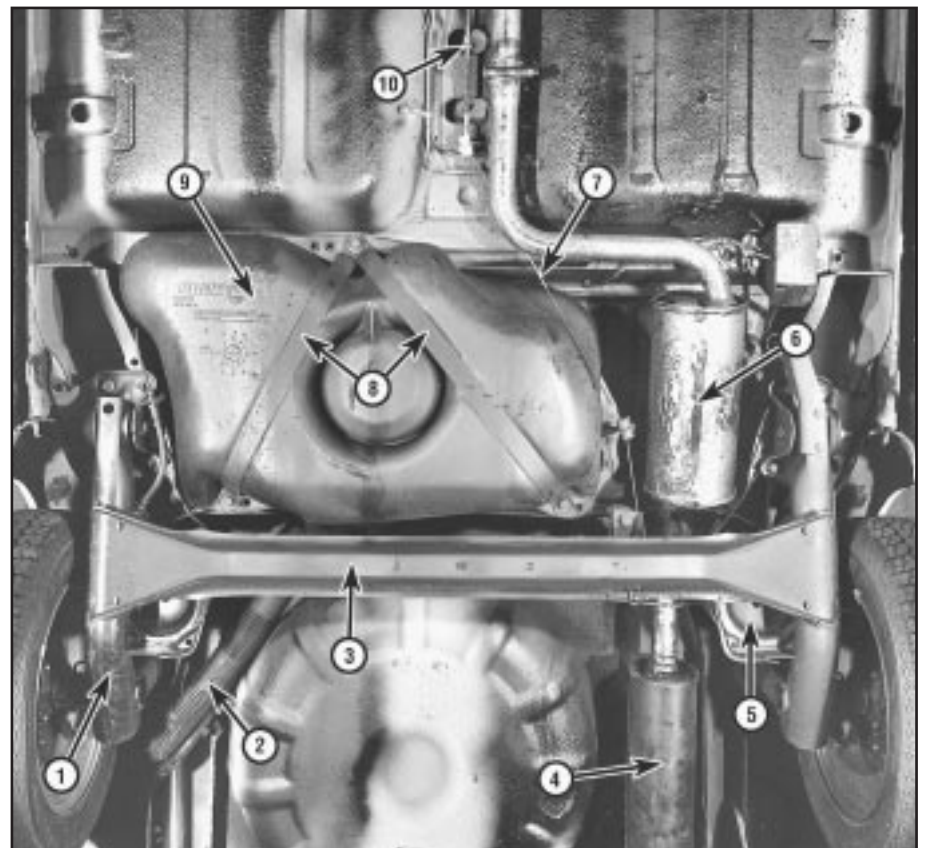

View of rear end from below

- 1 Suspension trailing arm
- 2 Fuel tank filler hose
- 3 Rear axle beam
- 4 Rear silencer
- 5 Spring seat
- 6 Expansion box
- 7 Handbrake cable
- 8 Fuel tank support strap
- 9 Fuel tank
- 10 Handbrake cable adjuster

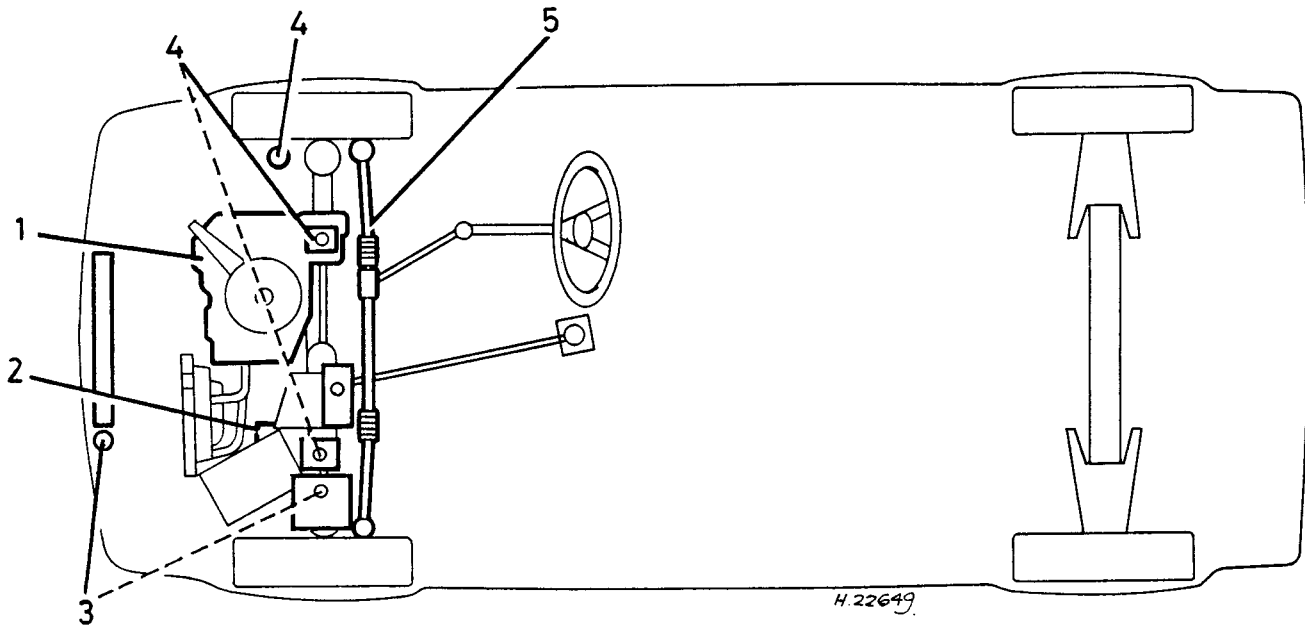

Component or system

Lubricant type/specification

1 Engine

Multigrade engine oil, viscosity SAE 15W/40, meeting API-SG or CCMC G2/G3 specification (or equivalent multigrade engine oil with viscosity rating suitable for ambient temperature in which vehicle is operated - see owner's handbook)

2 Transmission:

1372 cc Turbo ie model
All other models

FIAT ZC 80/S gear oil
FIAT ZC 90 gear oil

3 Cooling system

Ethylene glycol based antifreeze

4 Brake and clutch hydraulic system(s)

Hydraulic fluid to DOT 3 or 4, or SAE J1703C

5 Driveshaft CV joints and steering rack

Lithium based molybdenum disulphide

General greasing

Multi-purpose lithium based grease

0•14 Conversion Factors

Length (distance)

Inches (in)	x 25.4 = Millimetres (mm)	x 0.0394 = Inches (in)
Feet (ft)	x 0.305 = Metres (m)	x 3.281 = Feet (ft)
Miles	x 1.609 = Kilometres (km)	x 0.621 = Miles

Volume (capacity)

Cubic inches (cu in; in ³)	x 16.387 = Cubic centimetres (cc; cm ³)	x 0.061 = Cubic inches (cu in; in ³)
Imperial pints (Imp pt)	x 0.568 = Litres (l)	x 1.76 = Imperial pints (Imp pt)
Imperial quarts (Imp qt)	x 1.137 = Litres (l)	x 0.88 = Imperial quarts (Imp qt)
Imperial quarts (Imp qt)	x 1.201 = US quarts (US qt)	x 0.833 = Imperial quarts (Imp qt)
US quarts (US qt)	x 0.946 = Litres (l)	x 1.057 = US quarts (US qt)
Imperial gallons (Imp gal)	x 4.546 = Litres (l)	x 0.22 = Imperial gallons (Imp gal)
Imperial gallons (Imp gal)	x 1.201 = US gallons (US gal)	x 0.833 = Imperial gallons (Imp gal)
US gallons (US gal)	x 3.785 = Litres (l)	x 0.264 = US gallons (US gal)

Mass (weight)

Ounces (oz)	x 28.35 = Grams (g)	x 0.035 = Ounces (oz)
Pounds (lb)	x 0.454 = Kilograms (kg)	x 2.205 = Pounds (lb)

Force

Ounces-force (ozf; oz)	x 0.278 = Newtons (N)	x 3.6 = Ounces-force (ozf; oz)
Pounds-force (lbf; lb)	x 4.448 = Newtons (N)	x 0.225 = Pounds-force (lbf; lb)
Newtons (N)	x 0.1 = Kilograms-force (kgf; kg)	x 9.81 = Newtons (N)

Pressure

Pounds-force per square inch (psi; lbf/in ² ; lb/in ²)	x 0.070 = Kilograms-force per square centimetre (kgf/cm ² ; kg/cm ²)	x 14.223 = Pounds-force per square inch (psi; lbf/in ² ; lb/in ²)
Pounds-force per square inch (psi; lbf/in ² ; lb/in ²)	x 0.068 = Atmospheres (atm)	x 14.696 = Pounds-force per square inch (psi; lbf/in ² ; lb/in ²)
Pounds-force per square inch (psi; lbf/in ² ; lb/in ²)	x 0.069 = Bars	x 14.5 = Pounds-force per square inch (psi; lbf/in ² ; lb/in ²)
Pounds-force per square inch (psi; lbf/in ² ; lb/in ²)	x 6.895 = Kilopascals (kPa)	x 0.145 = Pounds-force per square inch (psi; lbf/in ² ; lb/in ²)
Kilopascals (kPa)	x 0.01 = Kilograms-force per square centimetre (kgf/cm ² ; kg/cm ²)	x 98.1 = Kilopascals (kPa)
Millibar (mbar)	x 100 = Pascals (Pa)	x 0.01 = Millibar (mbar)
Millibar (mbar)	x 0.0145 = Pounds-force per square inch (psi; lbf/in ² ; lb/in ²)	x 68.947 = Millibar (mbar)
Millibar (mbar)	x 0.75 = Millimetres of mercury (mmHg)	x 1.333 = Millibar (mbar)
Millibar (mbar)	x 0.401 = Inches of water (inH ₂ O)	x 2.491 = Millibar (mbar)
Millimetres of mercury (mmHg)	x 0.535 = Inches of water (inH ₂ O)	x 1.868 = Millimetres of mercury (mmHg)
Inches of water (inH ₂ O)	x 0.036 = Pounds-force per square inch (psi; lbf/in ² ; lb/in ²)	x 27.68 = Inches of water (inH ₂ O)

Torque (moment of force)

Pounds-force inches (lbf in; lb in)	x 1.152 = Kilograms-force centimetre (kgf cm; kg cm)	x 0.868 = Pounds-force inches (lbf in; lb in)
Pounds-force inches (lbf in; lb in)	x 0.113 = Newton metres (Nm)	x 8.85 = Pounds-force inches (lbf in; lb in)
Pounds-force inches (lbf in; lb in)	x 0.083 = Pounds-force feet (lbf ft; lb ft)	x 12 = Pounds-force inches (lbf in; lb in)
Pounds-force feet (lbf ft; lb ft)	x 0.138 = Kilograms-force metres (kgf m; kg m)	x 7.233 = Pounds-force feet (lbf ft; lb ft)
Pounds-force feet (lbf ft; lb ft)	x 1.356 = Newton metres (Nm)	x 0.738 = Pounds-force feet (lbf ft; lb ft)
Newton metres (Nm)	x 0.102 = Kilograms-force metres (kgf m; kg m)	x 9.804 = Newton metres (Nm)

Power

Horsepower (hp)	x 745.7 = Watts (W)	x 0.0013 = Horsepower (hp)
-----------------	---------------------	----------------------------

Velocity (speed)

Miles per hour (miles/hr; mph)	x 1.609 = Kilometres per hour (km/hr; kph)	x 0.621 = Miles per hour (miles/hr; mph)
--------------------------------	--	--

Fuel consumption*

Miles per gallon (mpg)	x 0.354 = Kilometres per litre (km/l)	x 2.825 = Miles per gallon (mpg)
------------------------	---------------------------------------	----------------------------------

Temperature

Degrees Fahrenheit = (°C x 1.8) + 32	Degrees Celsius (Degrees Centigrade; °C) = (°F - 32) x 0.56
--------------------------------------	---

* It is common practice to convert from miles per gallon (mpg) to litres/100 kilometres (l/100km), where mpg x l/100 km = 282

Chapter 1 Engine

For modifications, and information applicable to later models, see Supplement at end of manual

Contents

Part 1: General

Crankcase ventilation system	3
Description	1
Engine oil and filter	2
Major operations possible without removing the engine from the car	4

Part 2: 903 cc engine

Cylinder head - dismantling and decarbonising	17
Cylinder head - removal and refitting	7
Engine - complete dismantling	16
Engine - complete reassembly	20
Engine - dismantling (general)	14
Engine - initial start-up after overhaul or major repair	24
Engine - method of removal	12
Engine - reassembly (general)	19
Engine - refitting ancillary components	21
Engine - removing ancillary components	15
Engine mountings - renewal	11
Engine/transmission - reconnection	22
Engine/transmission - refitting	23
Engine/transmission - removal and separation	13
Examination and renovation	18
Fault finding - all engines	See end of Chapter
Oil pump - removal and refitting	10
Pistons/connecting rods - removal and refitting	9





Sump pan - removal and refitting	8
Timing chain and sprockets - removal and refitting	6
Valve clearances - adjustment	5

Part 3: 1116 cc and 1301 cc engines

Camshaft and camshaft carrier - removal and refitting	27
Cylinder head - dismantling and decarbonising	39
Cylinder head - removal and refitting	29
Engine - complete dismantling	38
Engine - complete reassembly	42
Engine - dismantling (general)	36
Engine - initial start-up after major overhaul	45
Engine - method of removal	34
Engine - reassembly (general)	41
Engine ancillary components - refitting	43
Engine ancillary components - removal	37
Engine mountings - renewal	33
Engine/transmission - reconnection and refitting	44
Engine/transmission - removal and separation	35
Examination and renovation	40
Fault finding - all engines	See end of Chapter
Oil pump - removal and refitting	31
Pistons/connecting rods - removal and refitting	32
Sump pan - removal and refitting	30
Timing belt - renewal	28
Valve clearances - adjustment	26
Valve clearances - checking	25

1

Degrees of difficulty

Easy , suitable for novice with little experience 	Fairly easy , suitable for beginner with some experience 	Fairly difficult , suitable for competent DIY mechanic 	Difficult , suitable for experienced DIY mechanic 	Very difficult , suitable for expert DIY or professional 
---	--	--	---	--

Specifications

903 cc engine

Type	Four cylinder in-line, liquid cooled, overhead valve. Transversely mounted with end-on transmission
General	
Bore	65.0 mm (2.56 in)
Stroke	68.0 mm (2.68 in)
Displacement	903 cc (55 cu in)
Compression ratio:	
900 models	9.0 : 1
900 ES models	9.7 : 1
Maximum power (DIN)	33.1 kW at 5600 rev/min (45 bhp)
Maximum torque (DIN):	
900 models	68 Nm at 3000 rev/min (49 lbf ft)
900 ES models	69 Nm at 3000 rev/min (51 lbf ft)
Compression pressure	9.3 to 10.35 bar (135 to 150 lbf/in ²)
Maximum pressure difference between cylinders	0.69 bar (10 lbf/in ²)
Firing order	1 - 3 - 4 - 2 (No. 1 at crankshaft pulley end)

1•2 Engine – general

Cylinder block and crankcase

Material	Cast-iron
Bore diameter	65.000 to 65.050 mm (2.5591 to 2.5610 in)
Diameter of camshaft bearing bores in crankcase timing gear end:	
Grade B	50.505 to 50.515 mm (1.9882 to 1.9886 in)
Grade C	50.515 to 50.525 mm (1.9886 to 1.9890 in)
Grade D	50.705 to 50.715 mm (1.9960 to 1.9964 in)
Grade E	50.715 to 50.725 mm (1.9964 to 1.9968 in)
Centre	46.420 to 46.450 mm (1.8275 to 1.8287 in)
Flywheel end	35.921 to 35.951 mm (1.4142 to 1.4154 in)
Maximum cylinder bore taper	0.015 mm (0.0006 in)
Maximum cylinder bore ovality	0.015 mm (0.0006 in)

Pistons and piston rings

Piston diameter:	
Grade A	64.940 to 64.950 mm (2.5566 to 2.5570 in)
Grade C	64.960 to 64.970 mm (2.5574 to 2.5578 in)
Grade E	64.980 to 64.990 mm (2.5582 to 2.5586 in)
Oversizes	0.2, 0.4, 0.6 mm (0.008, 0.016, 0.024 in)
Piston clearance in cylinder bore	0.050 to 0.070 mm (0.0020 to 0.0028 in)
Piston ring groove width:	
Top	1.785 to 1.805 mm (0.0703 to 0.0711 in)
Second	2.015 to 2.035 mm (0.0793 to 0.0801 in)
Bottom	3.975 to 3.977 mm (0.1566 to 0.1567 in)
Piston ring thickness:	
Top	1.728 to 1.740 mm (0.0680 to 0.0685 in)
Second	1.978 to 1.990 mm (0.0779 to 0.0784 in)
Bottom	3.925 to 3.937 mm (0.1545 to 0.1550 in)
Piston ring groove clearance:	
Top	0.045 to 0.077 mm (0.0018 to 0.0030 in)
Second	0.025 to 0.057 mm (0.0010 to 0.0022 in)
Bottom	0.020 to 0.052 mm (0.0008 to 0.0020 in)
Piston ring end gap:	
Top	0.25 to 0.45 mm (0.0098 to 0.0177 in)
Second	0.20 to 0.35 mm (0.0078 to 0.0137 in)
Bottom	0.20 to 0.45 mm (0.0078 to 0.0177 in)
Oversize piston rings	0.2, 0.4, 0.6 mm (0.008, 0.016, 0.024 in)
Gudgeon pin diameter:	
Grade 1	19.970 to 19.974 mm (0.7862 to 0.7863 in)
Grade 2	19.974 to 19.978 mm (0.7863 to 0.7865 in)
Grade 3	19.978 to 19.982 mm (0.7865 to 0.7866 in)
Oversize	0.2 mm (0.008 in)

Crankshaft

Journal diameter	50.785 to 50.805 mm (1.9994 to 2.0002 in)
Standard main bearing shell thickness	1.832 to 1.837 mm (0.0721 to 0.0723 in)
Undersizes	0.254, 0.508, 0.762, 1.016 mm (0.010, 0.020, 0.030, 0.040 in)
Crankshaft endfloat	0.06 to 0.26 mm (0.0024 to 0.0102 in)
Crankpin diameter	39.985 to 40.005 mm (1.5741 to 1.5750 in)
Standard big-end shell bearing thickness	1.807 to 1.813 mm (0.0712 to 0.0714 in)
Undersizes	0.254, 0.508, 0.762, 1.016 mm (0.010, 0.020, 0.030, 0.040 in)

Camshaft

Diameter of camshaft journals:	
Timing end	37.975 to 38.000 mm (1.4951 to 1.4961 in)
Centre	43.348 to 43.373 mm (1.7079 to 1.7088 in)
Flywheel end	30.975 to 31.000 mm (1.2194 to 1.2205 in)
Bush reamed diameters:	
Timing gear end*	38.025 to 38.050 mm (1.4971 to 1.4981 in)
Centre	43.404 to 43.424 mm (1.7088 to 1.7096 in)
Flywheel end	31.026 to 31.046 mm (1.2215 to 1.2223 in)
<i>*Supplied reamed to size</i>	
Cam lift	5.1 mm (0.201 in)
Outside diameter of cam follower	13.982 to 14.000 mm (0.5505 to 0.5512 in)
Oversizes	0.05 to 0.010 mm (0.002 to 0.004 in)
Cam follower running clearance	0.010 to 0.046 mm (0.0004 to 0.0018 in)

Cylinder head and valves

Material (cylinder head)	Light alloy
Maximum distortion	0.05 mm (0.002 in)
Valve guide bore in head	12.950 to 12.977 mm (0.5099 to 0.5109 in)
Valve guide outside diameter	13.010 to 13.030 mm (0.5122 to 0.5130 in)
Valve guide oversizes	0.5, 0.10, 0.25 mm (0.002, 0.004, 0.010 in)
Inside diameter of valve guide (reamed)	7.022 to 7.040 mm (0.2765 to 0.2772 in)
Guide fit in head (interference)	0.033 to 0.080 mm (0.0013 to 0.0032 in)
Valve stem diameter	6.982 to 7.000 mm (0.2748 to 0.2756 in)
Maximum clearance (valve stem to guide)	0.022 to 0.058 mm (0.0009 to 0.0023 in)
Valve seat angle	44° 55' to 45° 05'
Valve face angle	45° 25' to 45° 35'
Valve head diameter:	
Inlet	29.0 mm (1.1417 in)
Exhaust	26.0 mm (1.0236 in)
Contact band (valve to seat)	1.3 to 1.5 mm (0.0512 to 0.0591 in)
Valve clearance:	
Inlet	0.15 mm (0.006 in)
Exhaust	0.20 mm (0.008 in)
For timing check	0.60 mm (0.024 in)
Valve timing:	
Inlet valve:	
Opens	7° BTDC
Closes	36° ABDC
Exhaust valve:	
Opens	38° BBDC
Closes	5° ATDC

Lubrication system

Oil pump type	Gear, driven by shaft from camshaft
Tooth tip to body clearance	0.05 to 0.14 mm (0.0020 to 0.0055 in)
Gear endfloat	0.020 to 0.105 mm (0.0008 to 0.0041 in)
Oil pressure at normal operating temperature and average road/ engine speed	2.94 to 3.92 bar (42 to 57 lbf/ in ²)
Oil capacity (with filter change)	3.42 litre (6.0 pint)
Oil type/specification	Multigrade engine oil, viscosity SAE 15W/40
Oil filter	Champion C101

Torque wrench settings

	Nm	lbf ft
Cylinder head bolts:		
Stage 1	30	22
Stage 2	59	43.5
Camshaft sprocket bolt	49	36
Main bearing cap bolts	69	51
Big-end bearing cap bolts	41	30
Crankshaft pulley nut	98	72
Flywheel bolts	44	32
Rocker pedestal nuts	39	29
Engine mounting bracket bolts	25	18
Engine mounting centre nuts	49	36
Exhaust manifold nuts	20	15
Spark plugs	25	18
Temperature sender switch	49	36
Driveshaft to hub nuts	272	200
Hub carrier to strut clamp bolts	49	36
Roadwheel bolts	86	63
Brake caliper mounting bolts	53	39
Tie-rod end balljoint nuts	34	25
Driveshaft inboard boot retainer bolts	9	7

1•4 Engine – general

1116 cc and 1301 cc engine

Type	Four cylinder in-line, liquid cooled single overhead camshaft. Transversely mounted with end-on transmission	
General	1116 cc	1301 cc
Bore	80.0 mm (3.15 in)	86.4 mm (3.40 in)
Stroke	55.5 mm (2.19 in)	55.5 mm (2.19 in)
Displacement	1116 cc (68.08 cu in)	1301 cc (79.36 cu in)
Compression ratio	9.2 : 1	9.1 : 1
Maximum power (DIN)	40.5 kW (55 bhp) at 5600 rev/min	50 kW (68 bhp) at 5700 rev/min
Maximum torque (DIN)	86.3 Nm (64 lbf ft) at 2900 rev/min	100 Nm (74 lbf ft) at 2900 rev/min
Compression pressure (bore wear test)	10.35 to 11.73 bar (150 to 170 lbf/in ²)	
Pressure difference between cylinders	0.96 bar (14 lbf/ in ²)	
Firing order	1 - 3 - 4 - 2 (No. 1 at crankshaft pulley end)	

Pistons and piston rings

Piston diameter - 1116 cc:	
Grade A	79.940 to 79.950 mm (3.1496 to 3.1500 in)
Grade C	79.960 to 79.970 mm (3.1504 to 3.1508 in)
Grade E	79.980 to 79.990 mm (3.1512 to 3.1516 in)
Piston diameter - 1301 cc:	
Grade A	86.320 to 86.330 mm (3.4010 to 3.4014 in)
Grade C	86.340 to 86.350 mm (3.4018 to 3.4022 in)
Grade E	86.360 to 86.370 mm (3.4025 to 3.4030 in)
Oversizes	0.2, 0.4, 0.6 mm (0.008, 0.016, 0.023 in)
Piston clearance in cylinder bore:	
1116 cc	0.050 to 0.070 mm (0.0020 to 0.0027 in)
1301 cc	0.070 to 0.090 mm (0.0027 to 0.0035 in)
Piston ring groove width - 1116 cc:	
Top	1.535 to 1.555 mm (0.1442 to 0.1461 in)
Second	2.015 to 2.035 mm (0.0794 to 0.0802 in)
Bottom	3.957 to 3.977 mm (0.1559 to 0.1567 in)
Piston ring groove width - 1301 cc:	
Top	1.535 to 1.555 mm (0.0605 to 0.0613 in)
Second	2.030 to 2.050 mm (0.0800 to 0.0808 in)
Bottom	3.967 to 3.987 mm (0.1563 to 0.1571 in)
Piston ring thickness:	
Top	1.478 to 1.490 mm (0.0582 to 0.0587 in)
Second	1.978 to 1.990 mm (0.0779 to 0.0784 in)
Bottom	3.925 to 3.937 mm (0.1546 to 0.1551 in)
Oversizes	0.2, 0.4, 0.6 mm (0.008, 0.016, 0.023 in)
Piston ring groove clearance - 1116 cc:	
Top	0.045 to 0.077 mm (0.0018 to 0.0030 in)
Second	0.025 to 0.057 mm (0.0010 to 0.0022 in)
Bottom	0.020 to 0.052 mm (0.0008 to 0.0020 in)
Piston ring groove clearance - 1301 cc:	
Top	0.045 to 0.077 mm (0.0018 to 0.0030 in)
Second	0.040 to 0.072 mm (0.0016 to 0.0028 in)
Bottom	0.030 to 0.062 mm (0.0012 to 0.0024 in)
Piston ring end gap - 1116 cc:	
Top	0.30 to 0.45 mm (0.0012 to 0.0018 in)
Second	0.20 to 0.35 mm (0.008 to 0.014 in)
Bottom	0.20 to 0.35 mm (0.008 to 0.014 in)
Piston ring end gap - 1301 cc:	
Top	0.30 to 0.45 mm (0.012 to 0.016 in)
Second	0.30 to 0.50 mm (0.012 to 0.020 in)
Bottom	0.25 to 0.40 mm (0.010 to 0.016 in)
Gudgeon pin diameter - 1116 cc:	
Grade 1	21.970 to 21.974 mm (0.8656 to 0.8658 in)
Grade 2	21.974 to 21.978 mm (0.8658 to 0.8659 in)
Grade 3	21.978 to 21.982 mm (0.8659 to 0.8661 in)
Gudgeon pin diameter - 1301 cc:	
Grade 1	21.991 to 21.994 mm (0.8664 to 0.8666 in)
Grade 2	21.994 to 21.997 mm (0.8666 to 0.8667 in)
Oversize	0.2 mm (0.008 in)

Crankshaft

Journal diameter	50.785 to 50.805 mm (1.9994 to 2.0002 in)
Standard main bearing shell thickness	1.825 to 1.831 mm (0.0719 to 0.0721 in)
Undersizes	0.254, 0.508, 0.762, 1.016 mm (0.010, 0.020, 0.030, 0.040 in)
Crankshaft endfloat	0.06 to 0.26 mm (0.0024 to 0.0102 in)
Crankpin diameter	45.498 to 45.518 mm (1.7926 to 1.7934 in)
Standard big-end shell bearing thickness	1.531 to 1.538 mm (0.0603 to 0.0606 in)
Undersizes	0.254, 0.508, 0.762, 1.016 mm (0.010, 0.020, 0.030, 0.040 in)

Camshaft

Number of bearings	5
Diameter of camshaft journals:	
No. 1 (timing end)	29.944 to 29.960 mm (1.1798 to 1.1804 in)
No. 2	47.935 to 47.950 mm (1.8886 to 1.8892 in)
No. 3	48.135 to 48.150 mm (1.8965 to 1.8971 in)
No. 4	48.335 to 48.350 mm (1.9044 to 1.9050 in)
No. 5	48.535 to 48.550 mm (1.9122 to 1.9129 in)
Cam lift	8.8 mm (0.3467 in)
Camshaft bearing diameters in carrier:	
No. 1	29.990 to 30.014 mm (1.1816 to 1.1825 in)
No. 2	47.980 to 48.005 mm (1.8904 to 1.8913 in)
No. 3	48.180 to 48.205 mm (1.8982 to 1.8992 in)
No. 4	48.380 to 48.405 mm (1.9062 to 1.9072 in)
No. 5	48.580 to 48.605 mm (1.9141 to 1.9150 in)
Outside diameter of cam follower	36.975 to 36.995 mm (1.4568 to 1.4576 in)
Cam follower running clearance	0.005 to 0.050 mm (0.0002 to 0.0020 in)

Lubrication system

Oil pump type	Gear driven from auxiliary shaft
Tooth tip to body clearance	0.110 to 0.180 mm (0.0043 to 0.0071 in)
Gear endfloat	0.020 to 0.105 mm (0.0008 to 0.0041 in)
Oil pressure at normal operating temperature and average road/ engine speed	3.43 to 4.9 bar (50 to 71 lbf/in ²)
Oil capacity (with filter change)	4.05 litre (7.1 pint)
Oil type/specification	Multigrade engine oil, viscosity SAE 15W/40
Oil filter	Champion C106

Cylinder head and valves

Head material	Light alloy
Maximum distortion	0.05 mm (0.002 in)
Valve guide bore in head	13.950 to 13.977 mm (0.5496 to 0.5507 in)
Valve guide outside diameter	14.040 to 14.058 mm (0.5532 to 0.5539 in)
Valve guide oversizes	0.05, 0.10, 0.25 mm (0.002, 0.004, 0.010 in)
Inside diameter of valve guide (reamed)	8.022 to 8.040 mm (0.3161 to 0.3168 in)
Valve guide fit in cylinder head (interference)	0.063 to 0.108 mm (0.0025 to 0.0043 in)
Valve stem diameter	7.974 to 7.992 mm (0.3142 to 0.3149 in)
Maximum clearance (valve stem to guide)	0.030 to 0.066 mm (0.0012 to 0.0026 in)
Valve face angle	45° 25' to 45° 35'
Valve seat angle	44° 55' to 45° 05'
Valve head diameter:	
Inlet	35.850 to 36.150 mm (1.4125 to 1.4243 in)
Exhaust	30.850 to 31.450 mm (1.2155 to 1.2391 in)
Contact band (valve to seat)	1.3 to 1.5 mm (0.0512 to 0.0591 in)
Valve clearance:	
Inlet	0.40 mm (0.0158 in)
Exhaust	0.50 mm (0.0197 in)
For timing check	0.80 mm (0.0315 in)
Valve clearance adjusting shim thicknesses	3.25 to 4.70 mm (0.128 to 0.185 in), in increments of 0.05 mm (0.002 in)
Valve timing:	
Inlet valve:	
Opens	7° BTDC
Closes	35° ABDC
Exhaust valve:	
Opens	37° BBDC
Closes	5° ATDC

Auxiliary shaft

Bearing internal diameter (reamed):	
No. 1 (timing belt end)	35.664 to 35.684 mm (1.4052 to 1.4059 in)
No. 2	32.000 to 32.020 mm (1.2608 to 1.2616 in)
Shaft journal diameter:	
No. 1 (timing belt end)	35.593 to 35.618 mm (1.4024 to 1.4033 in)
No. 2	31.940 to 31.960 mm (1.2584 to 1.2592 in)

Cylinder block and crankcase

Material	Cast-iron
Bore diameter:	
1116 cc	80.000 to 80.050 mm (3.152 to 3.154 in)
1301 cc	86.400 to 86.450 mm (3.404 to 3.406 in)
Maximum cylinder bore taper	0.015 mm (0.0006 in)
Maximum cylinder bore ovality	0.015 mm (0.0006 in)

Torque wrench settings

	Nm	lbf ft
Cylinder head bolts:		
Stage 1	20	15
Stage 2	40	30
Stage 3	Turn through 90°	Turn through 90°
Stage 4	Turn through 90°	Turn through 90°
Camshaft carrier to cylinder head	20	15
Main bearing cap bolts	80	59
Big-end cap nuts	51	38
Flywheel mounting bolts	83	61
Camshaft sprocket bolt	83	61
Belt tensioner bolt	44	32
Exhaust manifold nuts	28	21
Auxiliary shaft sprocket bolt	83	61
Flexible mounting bracket bolts	59	44
Flexible mounting centre nuts	49	36
Oil pressure switch	32	24
Spark plugs	25	18
Roadwheel bolts	86	63
Driveshaft/hub nuts	272	200
Tie-rod end balljoint nuts	34	25
Brake caliper mounting bolts	53	39
Front strut lower clamp bolts	49	36
Driveshaft inboard boot retainer bolts	9	7
Crankshaft pulley nut	98	7

Part 1: General

1 Description

1 The Uno may be powered by one of three engines depending upon the particular model.

903 cc

2 This is of four cylinder overhead valve type with a light alloy cylinder head and a cast-iron block and crankcase.

3 A three bearing crankshaft is used and the chain-driven camshaft runs in three steel backed white metal bearings.

4 The light alloy pistons are fitted with two compression and one oil control ring. The gudgeon pin is an interference fit in the small end of the connecting rod.

5 Lubrication is provided by an oil pump within the sump pan and both the pump and the distributor are driven from a gear on the camshaft. Pressurised oil passes through a

cartridge type oil filter. An oil pressure relief valve is incorporated in the oil pump. The engine oil is independent of the transmission lubricant.

1116 cc and 1301 cc

6 These engines are of single overhead camshaft type, the camshaft being driven by a toothed belt.

7 The difference in engine capacity is achieved by increasing the cylinder bore on the 1301 cc engine.

8 The cylinder head is of light alloy while the cylinder block and crankcase are of cast-iron construction.

9 A five bearing crankshaft is used and the camshaft runs in a similar number of bearings, but as these are in-line bored directly in the camshaft carrier, no repair is possible.

10 The pistons are of light alloy with two compression and one oil control ring. The gudgeon pin is an interference fit in the small end of the connecting rod.

11 An auxiliary shaft, driven by the timing belt is used to drive the distributor, oil pump and fuel pump.

12 The oil pump is located within the sump pan and incorporates a pressure relief valve.

13 Pressurised oil passes through a cartridge type oil filter.

14 The crankshaft main bearings are supplied under pressure from drillings in the crankcase from the main oil gallery whilst the connecting rod big-end bearings are lubricated from the main bearings by oil forced through the crankshaft oilways. The camshaft bearings are fed from a drilling from the main oil gallery. The cams and tappets are lubricated by oil mist from outlets in the camshaft bearings.

15 The cylinder walls, pistons and gudgeon pins are lubricated by oil splashed up by the crankshaft webs. An oil pressure warning light is fitted to indicate when the pressure is too low.

All engines

16 The engine is mounted transversely with the transmission at the front of the car.

17 The engine oil is independent of the transmission lubricant.