

# **ELECTRIC SYSTEM**

**0000-00**

## **INDEX**

## **ELECTRIC SYSTEM**

### **ELECTRIC GENERAL**

1. LOCATIONS OF INTERIOR UNITS AND SENSORS .....	2
2. SWITCHES, UNITS AND SENSORS IN ENGINE COMPARTMENT.....	4
3. INTERIOR SWITCHES.....	6
4. AUDIO / VIDEO SYSTEM.....	8
5. ELECTRIC COMPONENTS AND LAYOUT.....	10

**ELECTRIC SYSTEM**

**0000-00**

**ELECTRIC GENERAL**

**1. LOCATIONS OF INTERIOR UNITS AND SENSORS**

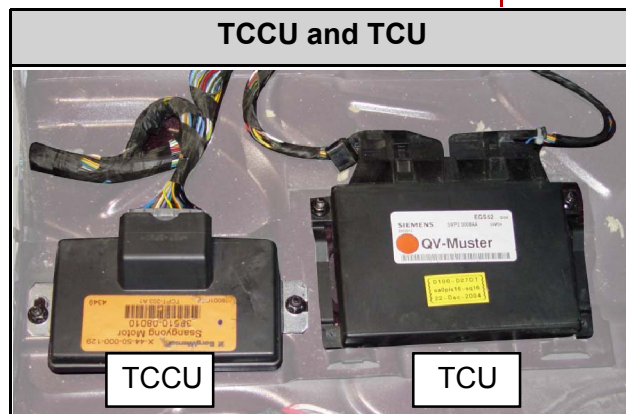
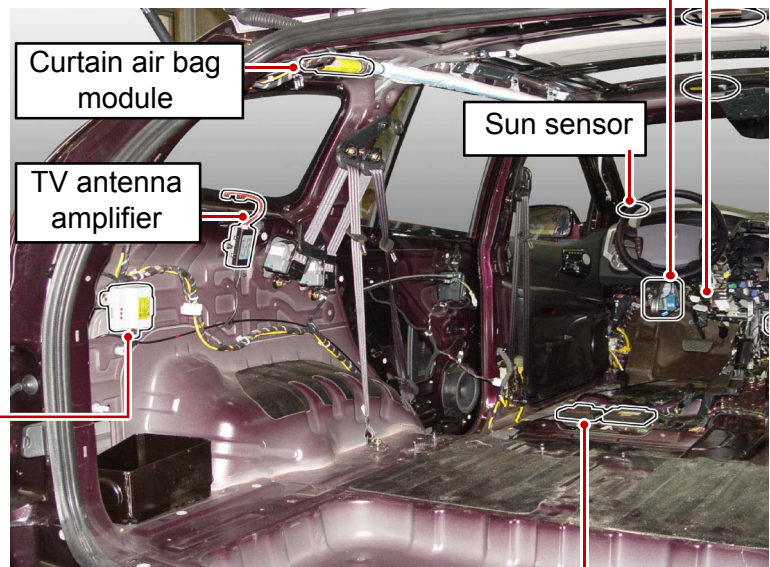
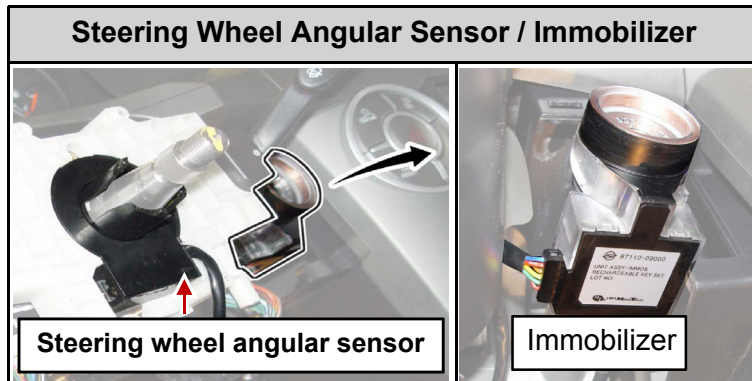
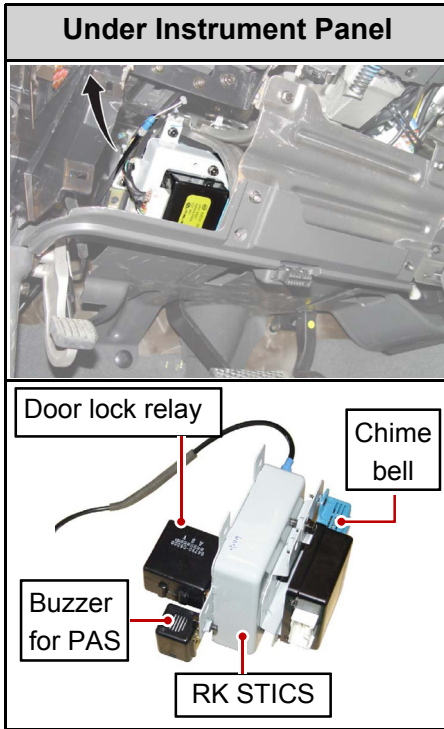

Modification basis	
Application basis	
Affected VIN	

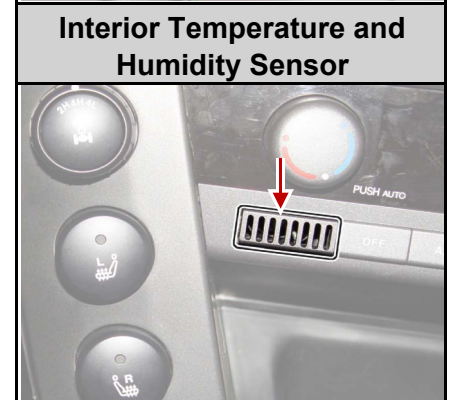
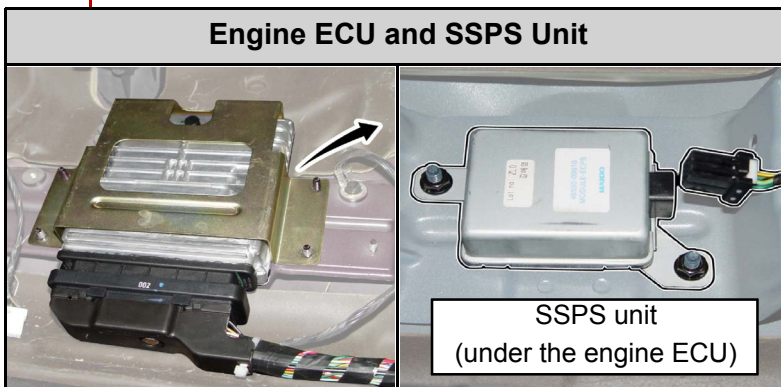
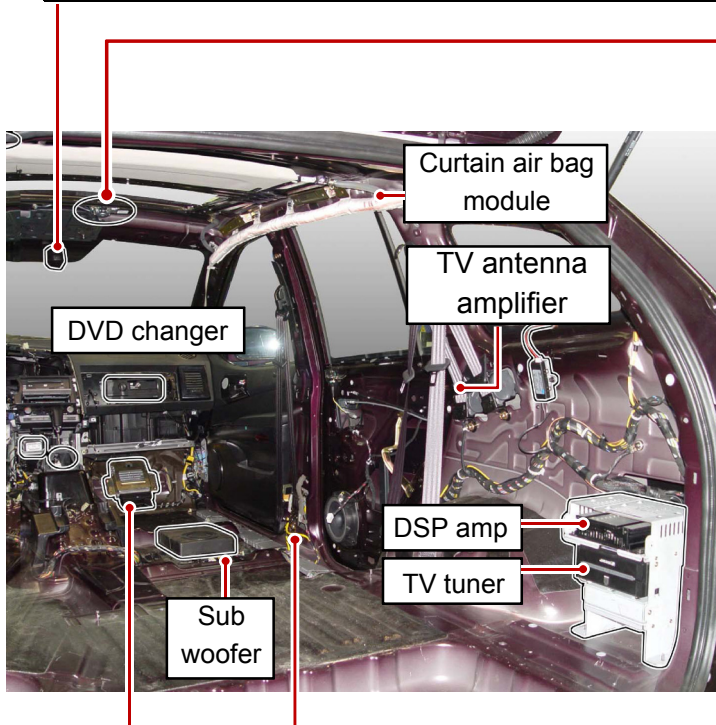
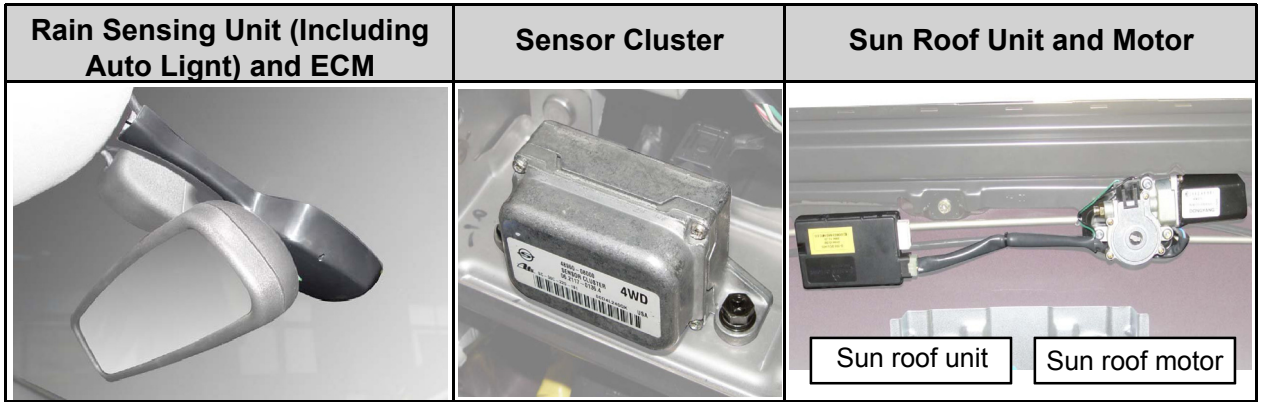

Modification basis	
Application basis	
Affected VIN	



## 2. SWITCHES, UNITS AND SENSORS IN ENGINE COMPARTMENT

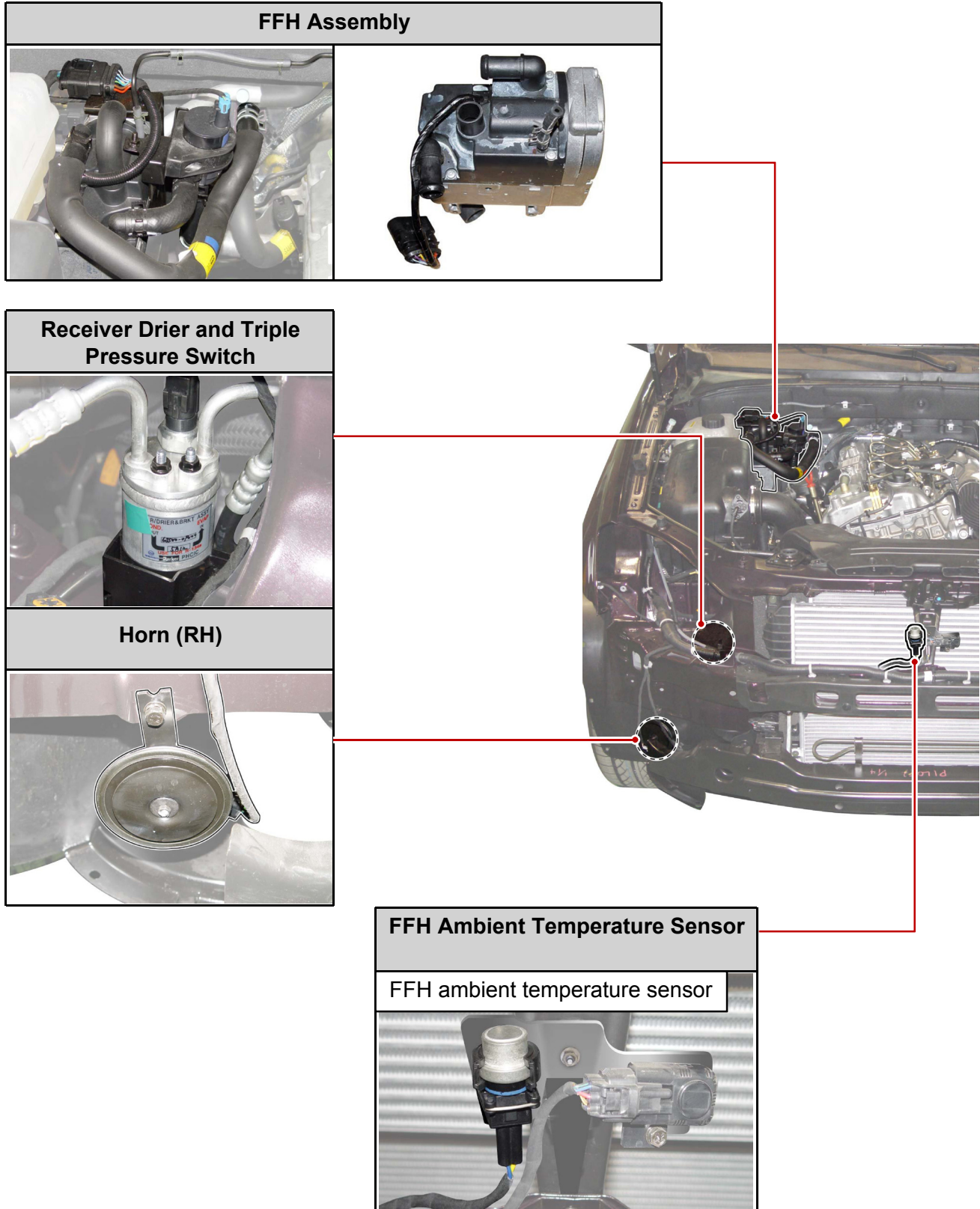

Modification basis	
Application basis	
Affected VIN	

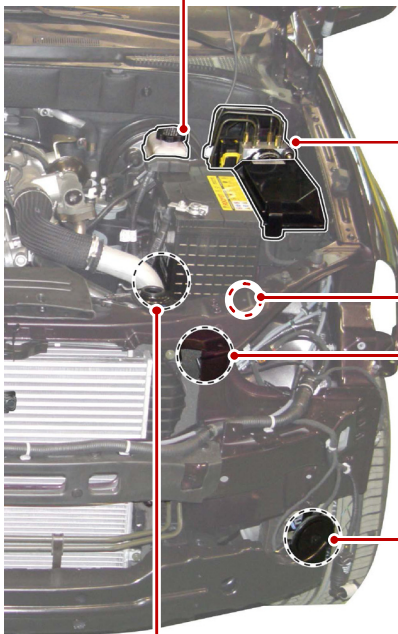
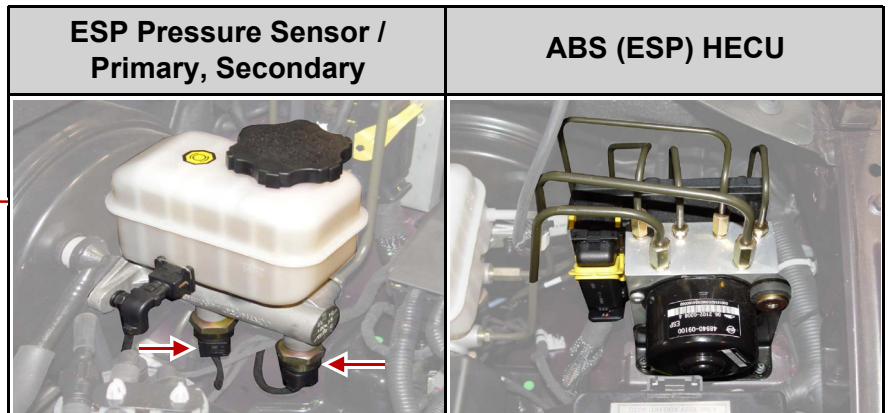

Hood Contact Switch

Horn (LH)

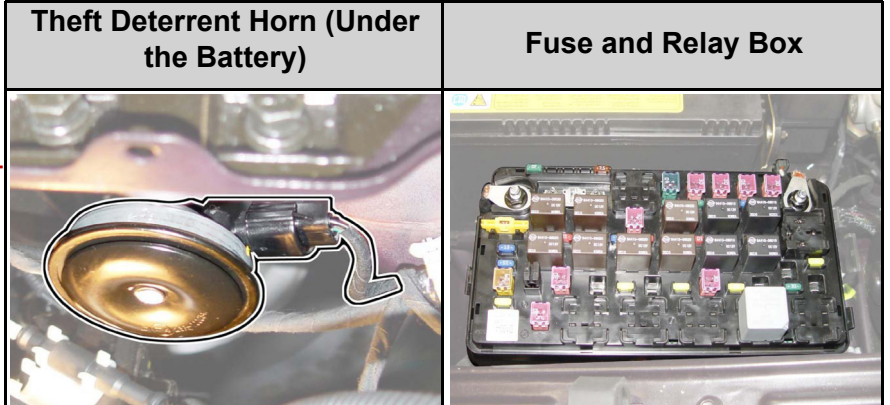
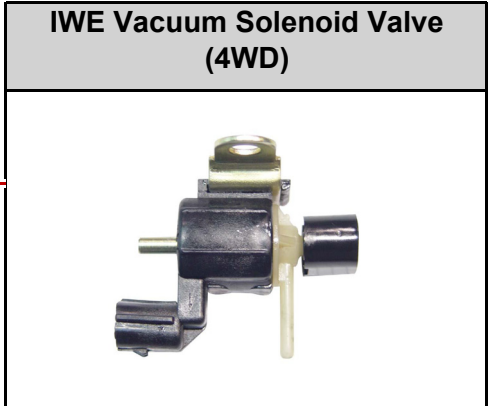

Modification basis	
Application basis	
Affected VIN	

### 3. INTERIOR SWITCHES

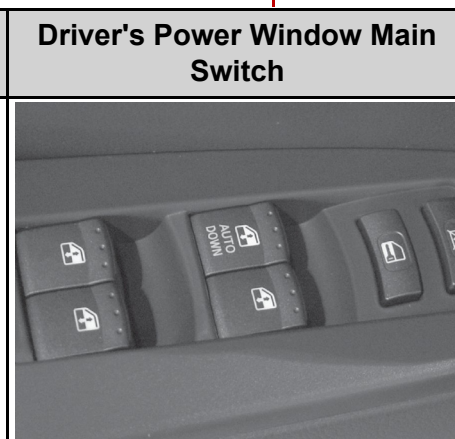
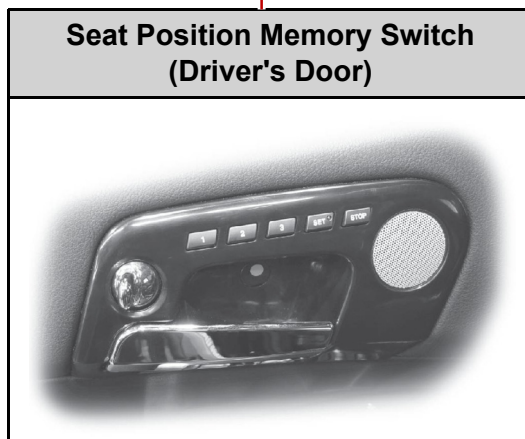
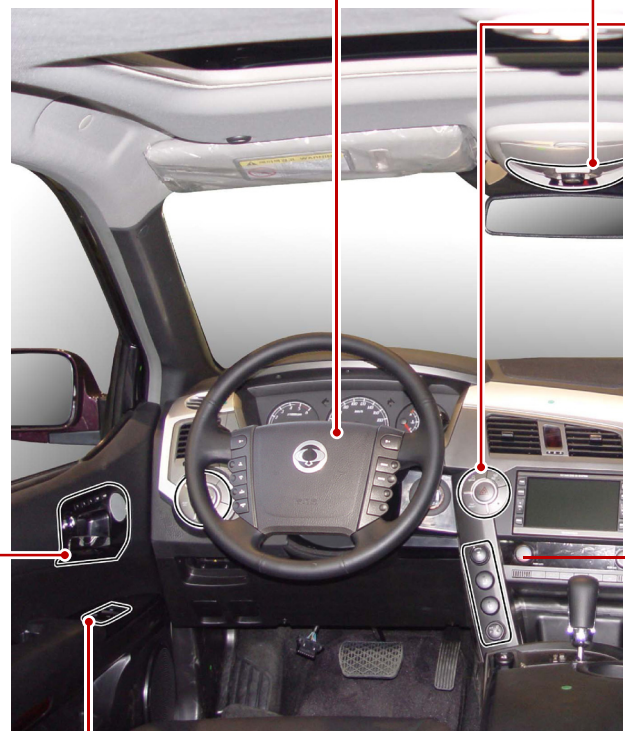
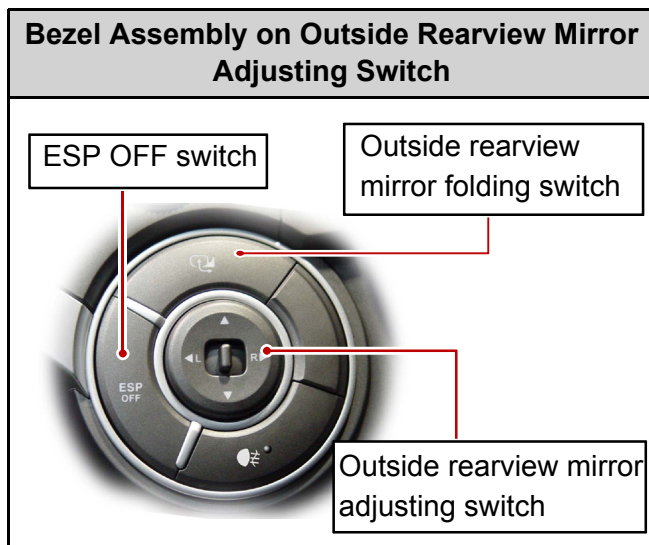

Modification basis	
Application basis	
Affected VIN	



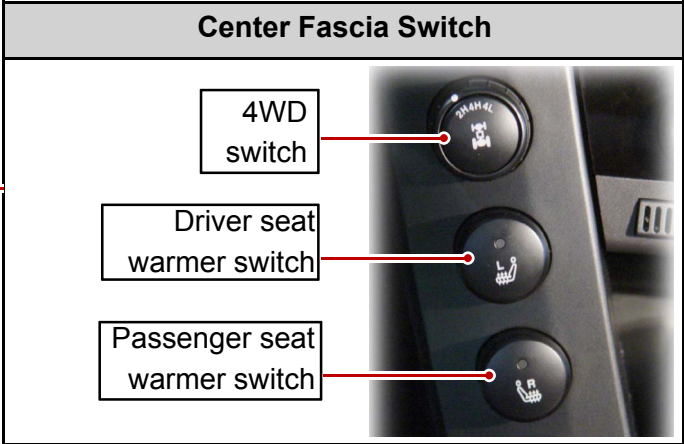
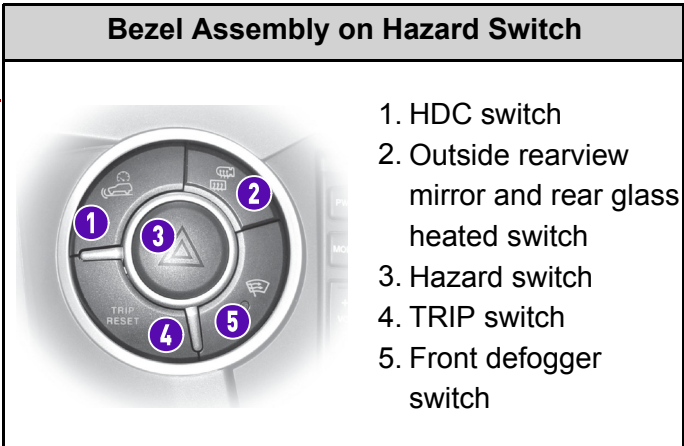
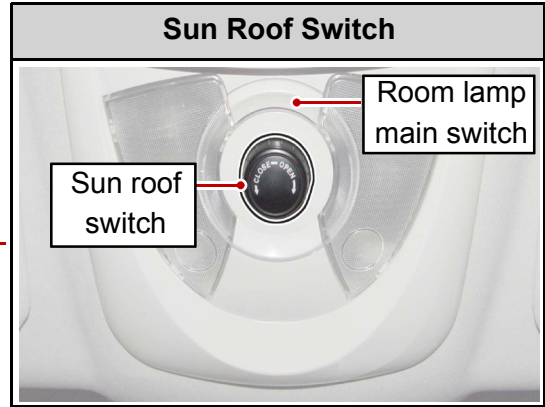

Modification basis	
Application basis	
Affected VIN	

ELECTRIC  
FUSE AND  
STICS  
IMMO  
SPWM  
CLUSTER  
LAMP  
SWITCH  
WIPER  
undefin ed  
undefin ed  
undefin ed  
undefin ed

## 4. AUDIO / VIDEO SYSTEM

### ▶ AV System

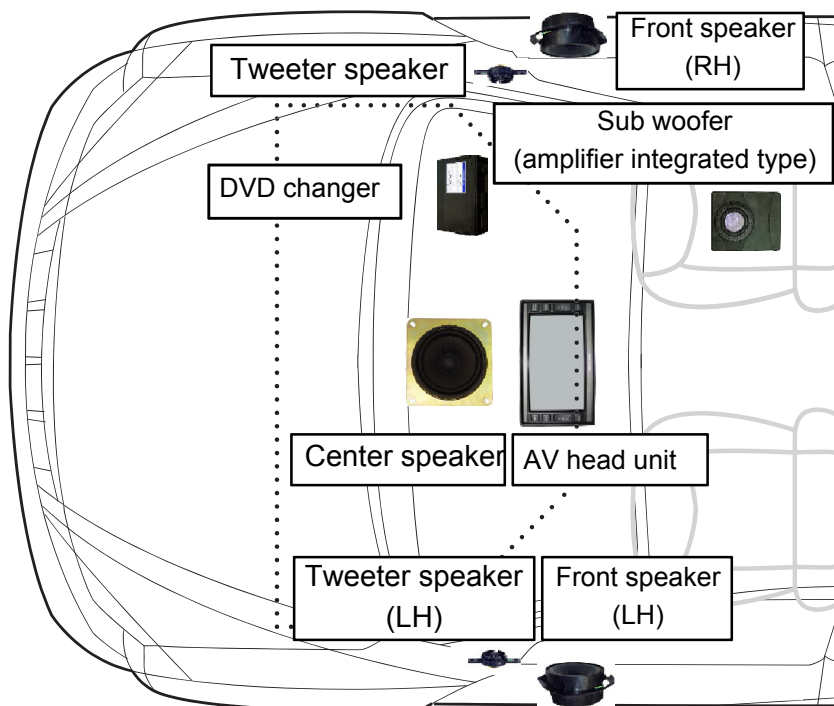
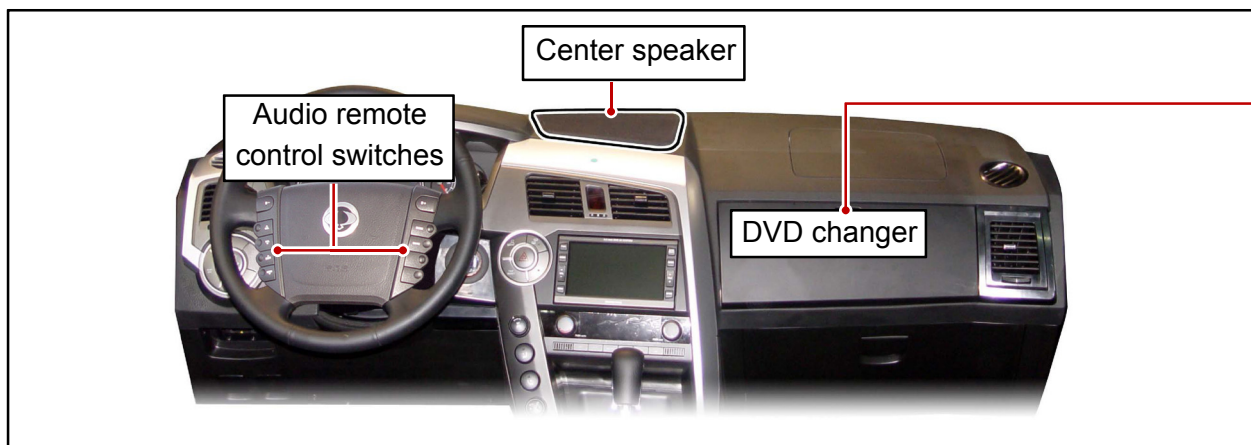

Modification basis	
Application basis	
Affected VIN	