

GT2550 Tractor 2009 & After  
Battery, Electrical Components & Switches

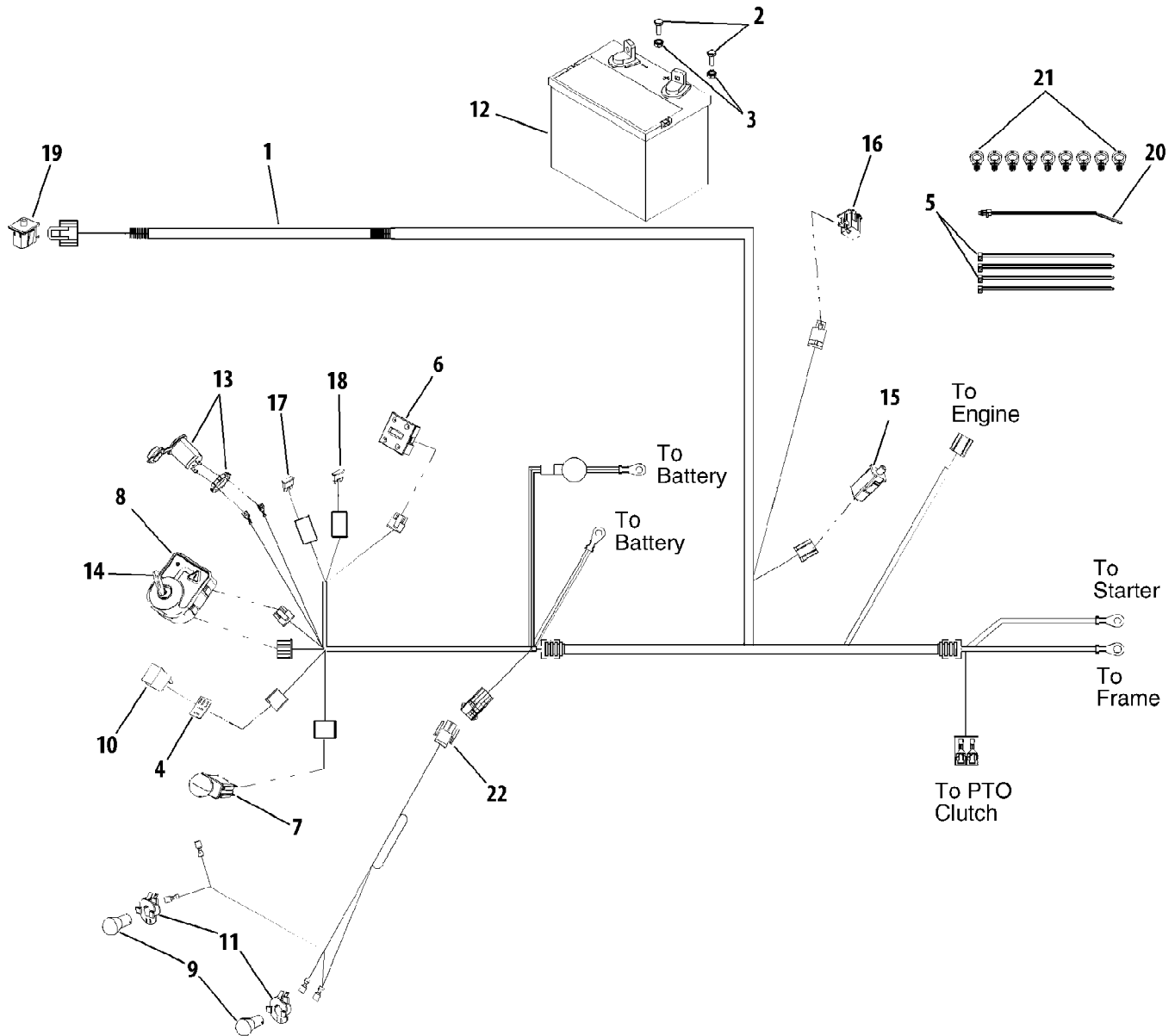

Ref #	Part Number	Qty	S/P/F	Description
1	929-04158A	1	/P	Wire Harness, Main
2	710-3015	2	/P	Screw, Hex, 1/4-20 x .75 GR5
3	712-0271	2	/P	Sems Nut
4	921-0342	1	/P	Gasket, Silicone
5	725-0157	4	/P	Tie, Self-Clinch Cable
6	925-04022B	1	/P	Meter, Indicator / Hour
7	925-04175	1	/P	Switch, PTO
8	925-04227B	1	/P	Switch, Key/Module
9	925-0963	2	/P	Lamp, Head Light
10	925-1648	1	/P	Relay
11	925-1649	2	/P	Socket, Light, 1/4 Turn
12	925-1707D	1	/P	Battery
13	725-2003	1		Receptacle, Power 12V
14	925-2054A	2	/P	Key, Ignition
15	925-3164A	1	/P	Switch, Interlock (Brake)
16	925-3167	1	/P	Switch, Snap Mount (Reverse)
17	725-3243	2		Fuse, 25 Amp
18	725-04008	1		Fuse, 5 Amp
19	925-04040	1	/P	Switch, Seat
20	926-0154	9	/P	Tie, Pushmount
21	726-3055	9		Clip, Cable
22	629-04142A	1	/P	Harness, Head Light

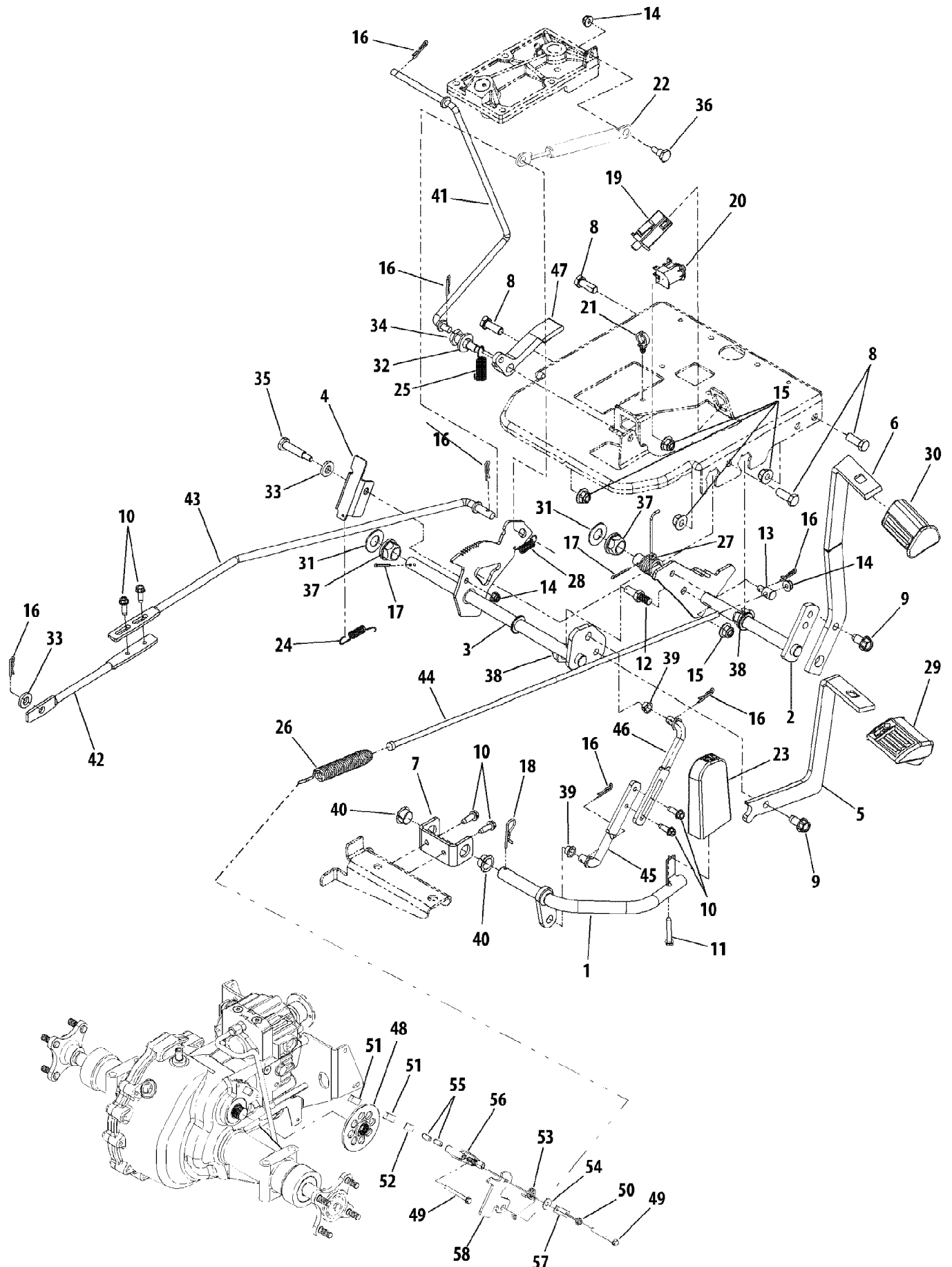

Ref #	Part Number	Qty	S/P/F	Description
1	603-0412	1		Pedal Assy, Reverse
2	603-04313A	1	/P	Shaft Assy, Brake
3	603-04314	1		Shaft Assy, Forward/Reverse
4	703-05873-0637	1		Bracket, Reverse Switch
5	703-2570A-0637	1		Pedal, Forward
6	703-2573A-0637	1		Pedal, Brake
7	703-2938	1		Bracket, Reverse Pivot
8	710-0514	4	/P	Screw, Hex Cap, 3/8-16 x 1.0 GR5
9	710-0623	2	/P	Screw, Hex Wash Hd Tapp, 3/8-16x .75
10	710-0642	6	/P	Screw, Hex Wash Hd Tapp, 1/4-20x .75
11	710-0796	1	/P	Screw, Truss Mach, #12 x 1.5
12	711-04543	1		Pin, 3/8-16 x 1.0
13	711-0736	1	/P	Ferrule, Adjustment, 1/4-20 Thrd
14	712-04064	3	/P	Nut, Hex Flange Lock, 1/4-20
15	712-04065	5	/P	Nut, Hex Flange Lock, 3/8-16
16	914-0104	7	/P	Pin, Internal Cotter, 5/16 Dia x 1.12
17	914-0111	2	/P	Pin, Cotter, 3/32 x 1.0
18	914-0145	1	/P	Pin, Internal Cotter, 3/8 Dia x 1.62
19	925-3164A	1	/P	Switch, Interlock (Brake)
20	925-3167	1	/P	Switch, Snap Mount (Reverse)
21	726-3055	1		Clip, Cable Retainer
22	727-04141	1		Cylinder, Damper, .59 OD x 7.84 Lg
23	931-3205	1	/P	Pedal, Reverse
24	732-0418	1		Spring, Extension, .38 OD x 2.1
25	732-04354	1		Spring, Extension
26	732-0463A	1	/P	Spring, Extension
27	932-0756A	1	/P	Spring, Torsion
28	732-3118	1		Spring, Extension, .375 OD x 1.44
29	735-3048	1		Pad, Forward Foot Control
30	735-3049A	1	/P	Pad, Brake Foot
31	736-0187	2	/P	Washer, Flat, .64 x 1.24 x .06 HT
32	936-0326	1	/P	Washer, Flat, .51 x 1.0 x .125
33	736-3010	2	/P	Washer, Flat, .407 x .812 x .135 HT
34	938-0145	1	/P	Shoulder Bolt, .50 OD x .840
35	938-0560	1	/P	Screw, Shoulder, .374 x 1.375
36	938-0974	1	/P	Screw, Shoulder, .375 x .380:1/4-20
37	941-0225	2	/P	Bearing, Hex Flange
38	741-3065B	2	/P	Bearing, Hex Flange Split
39	941-3073	2	/P	Bearing, Flange, .375 x .58 x .25
40	741-3074	2		Bearing, Flange, .625 x .938 x .344
41	747-04426	1		Rod, Cruise
42	747-04478	1		Rod, Rear F/R Control
43	747-04479	1		Rod, Front F/R Control
44	747-04516	1		Rod, Brake
45	747-3341A	1	/P	Rod, Rear Connecting
46	747-3383	1	/P	Rod, Front Connecting
47	748-04102	1		Latch, Cruise
48	761-0215	1		Disc, Brake
49	710-1206	2	/P	Screw, Hex Wash Hd, Tapp, 1/4-20 x 2.375
50	912-0273	1	/P	Nut, Hex Nylon Lock, 5/16-24
51	917-0678	2	/P	Pad, Brake
52	917-0682	1	/P	Plate, Puck
53	732-0925	1		Spring, Torsion

Ref #	Part Number	Qty	S/P/F	Description
54	736-0371	1	/P	Washer, Flat, .343 x .88 x .062
55	941-0343	2	/P	Pin, Brake Actuating
56	761-0207A	1	/P	Yoke, Brake
57	761-0208	1		Bracket, Brake Anti Rotation
58	761-3074	1		Arm, Brake Actuator

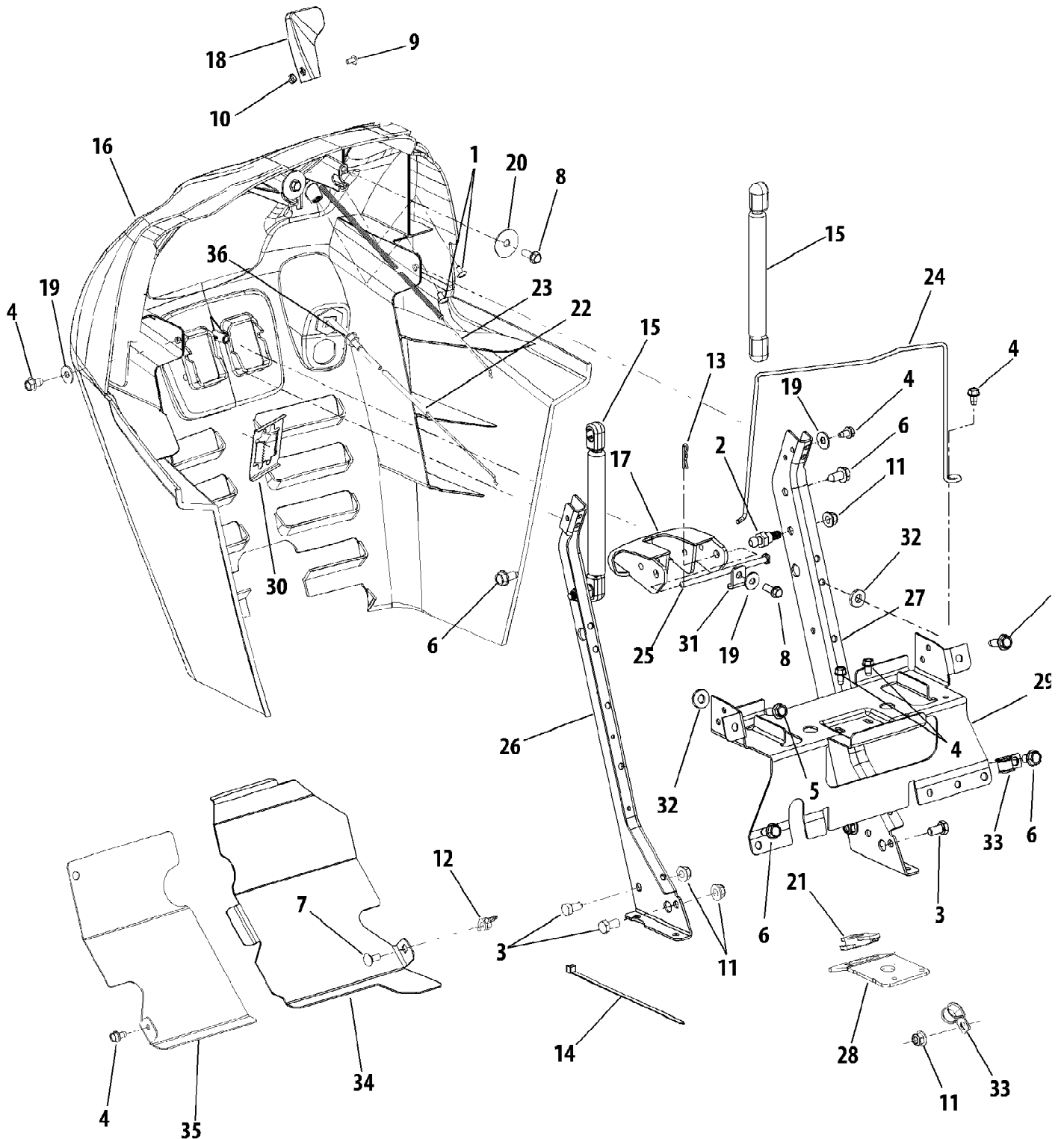

GT2550 Tractor 2009 & After  
Dash Panel & Engine Controls

Ref #	Part Number	Qty	S/P/F	Description
1	710-0192	2	/P	Screw, #10-24 x .375
2	710-04471	2		Screw, Ball Shoulder. 5/16-18 x .48
3	710-3025	4	/P	Screw, Hex Cap, 5/16-18 x .625 GR5
4	710-0599	6	/P	Screw, Self-tapping, 1/4-20, 0.500
5	710-0650	2	/P	Screw, Hx. Wash. Hd, Tapp. 5/16-18 x .875
6	710-0726	6	/P	Screw, Hx. Wash. Hd, Tapp, 5/16-12 x .75
7	710-0134	1	/P	Screw, Carriage, 1/4 -20 x .62
8	710-0895	2		Screw, 1/4-15, 0.75
9	710-3217	1	/P	Screw, Truss Mach., #8-32 x .375
10	712-0142	1	/P	Nut, Hex, #8-32 GrA
11	712-04063	6	/P	Nut, Hx Insert Flange Lck, 5/16-18 GrF
12	712-3087	1	/P	Nut, Wing, 1/4-20
13	914-0104	1	/P	Internal Cotter Pin, .072 x 1.13
14	725-0157	1	/P	Tie, Cable
15	727-04142	2		Cylinder, Gas
16	731-05354A	1		Dash
16	777I22459	1		Graphic, Dash Insert Not shown
16	977I22280	1	/P	Graphic, Throttle Not shown
17	731-05447	1		Lever, Dash, Cruise
18	931-3161A	1	/P	Knob, Throttle Control
19	736-0173	3	/P	Washer, Flat, .28 x .74 x .063
20	736-0362	2	/P	Washer, Flat, .33 x 1.25 x .06 HT
21	731-05659	1		Bushing, Steering Shaft
22	746-04277	1	S	Cable, Choke
23	746-1100	1	S	Cable, Throttle Control
24	747-04215-0637	1	/P	Strap, Battery
25	747-1323A	1		Rod, .25 x 4.55
26	783-04285F-0637	1	/P	Plate, Dash Support RH
27	783-04323F-0637	1	/P	Plate, Dash Support, LH
28	783-05240A-0637	1		Bracket, Steering Support
29	783-05469-0637	1		Bracket, Battery Support
30	783-0462	1	/P	Bracket, PTO Switch Retainer
31	783-1499-0637	1	/P	Bracket, Rod, Dash
32	936-3008	6	/P	Washer, Flat, .344 x .75 x .12
33	726-0272	2	/P	Clamp, 9/16
34	703-06668-0637	1		Shield, Engine, LH
34	777S32728	1		Graphic, Steering Box Access Panel Not shown
35	703-05884-0637	1		Shield, Engine, RH
36	912-3005	1	/P	Nut, Flange Lock, 3/8-16 Gr5