

GT2186-48 Tractor
Air Intake And Filtration

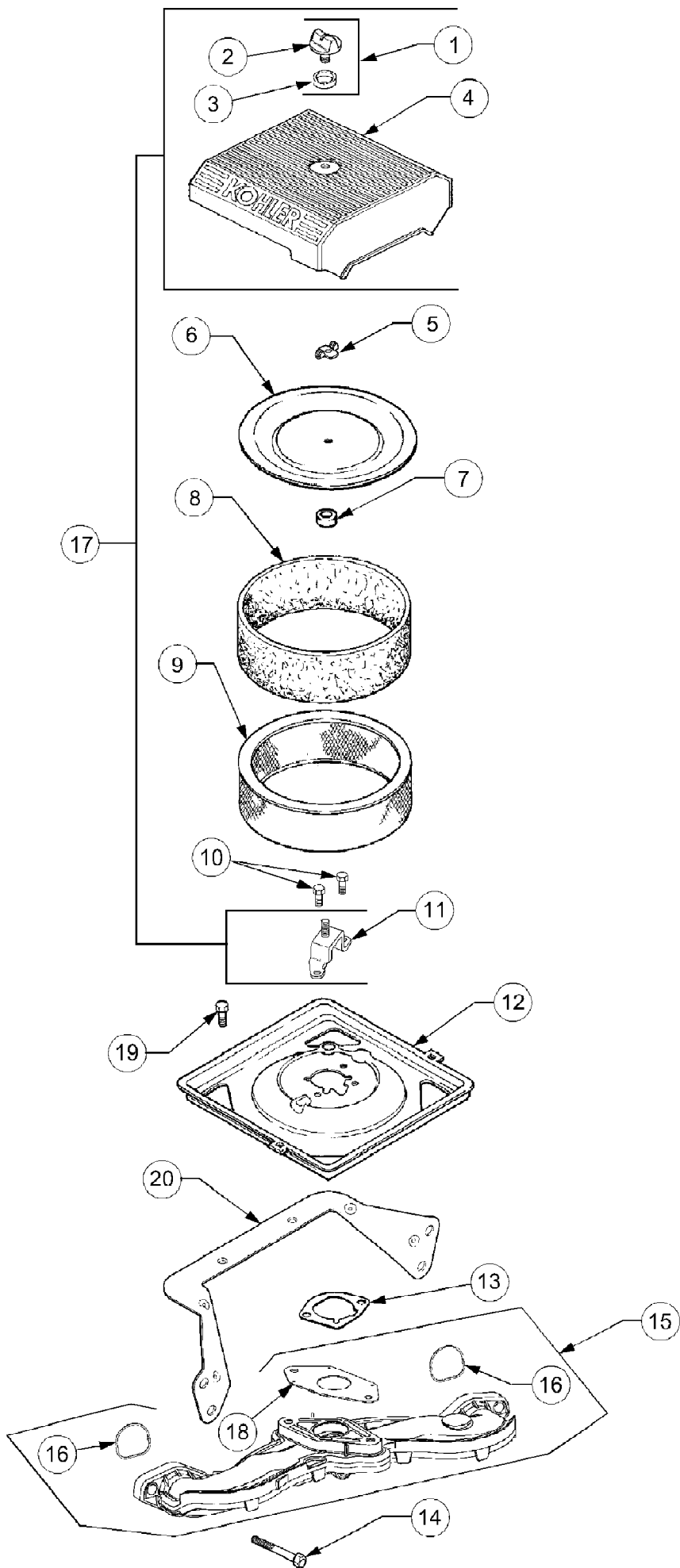

Ref #	Part Number	Qty	S/P/F	Description
1	KH-54-755-01	1	S	Kit, Knob w/Seal (Incl. Ref #2,3)
2	KH-25-341-03	1	/P	Knob, Cover
3	KH-24-153-20-S	1		Seal, Air Cleaner Cover Knob
4	KH-24-096-69-S	1	/P	Cover, Air Cleaner
5	KH-12-100-01	1	/P	Wing Nut
6	KH-24-096-01	1	/P	Cover, Inner Air Cleaner
7	KH-24-032-03	1	/P	Seal, Inner Air Cleaner
8	KH-24-083-02	1	S	Precleaner, Element
9	KH-47-083-03	1	S	Element, Air Cleaner
10	KH-M-0639016	3	S	Screw, Hex Flange, M6 x 1.0 x 16
11	KH-24-126-21	1		Bracket, Air Cleaner Base
12	KH-24-094-24-S	1	S	Base, Air Cleaner
13	KH-24-041-06	1	/P	Gasket, Air Cleaner Base
14	KH-M-0651040-S	4		Screw, Hex Flange, M6 x 1.0 x 40
15	KH-24-164-54-S	1	S	Manifold, Intake (Includes Carb Gasket KH-24-041-53-S and (2) O-Rings KH-24-153-27-S)
16	KH-24-153-27-S	2	/P	O-Ring, Intake Manifold
17	KH-24-743-08	1		Kit, Air Cleaner Cover (Incl 1-4, 11)
18	KH-24-041-53-S	1		Gasket, Carburetor
19	KH-M-0545010	2	/P	Screw, Hex Flng, M5 x 0.8 x 10
20	KH-24-126-130-S	1		Bracket, Air Cleaner Base

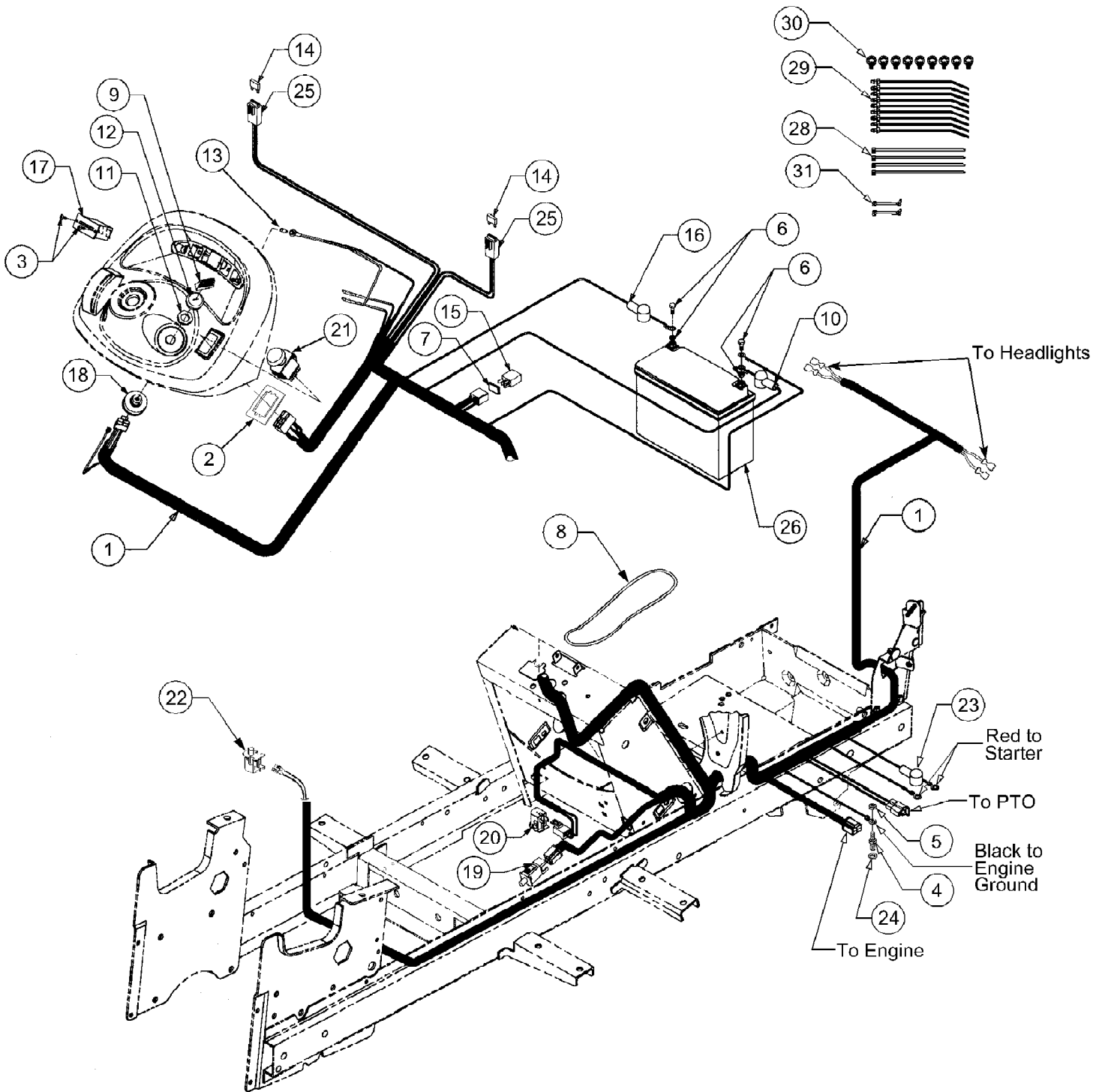

GT2186-48 Tractor
Battery, Electrical Components And Switches

Page 4 of 76

Ref #	Part Number	Qty	S/P/F	Description
1	629-3068A	1	S	Wire Harness, Main
2	783-0462	1	/P	Bracket, PTO Switch Retainer
3	710-0936	A/R		Screw, Truss Hd Tapp, #6 x .62
4	711-1094	1		Stud, Ground
5	712-3010	1	S	Nut, Hex, 5/16-18 GR5
6		1		Battery Cable Hardware
	710-3015	2	/P	Screw
	712-0271	2	/P	Sems Nut
7	721-0342	1	S	Gasket, Silicone
8	723-04016	1		Strap, Battery Retainer
9	759-3476A	1	S	Key, Ignition (Set of 2)
10	725-0340	1		Cover, Terminal Black
11	725-1346	1	S	Nut, Ignition Switch
12	725-1347	1	/P	Cap, Ignition Switch
13	725-1365	1	S	Bulb, Indicator
14	725-3243	2		Fuse, 25 Amp
15	725-1648	1	S	Relay
16	725-3007A	1	/P	Cover, Terminal Red
17	725-3159	1	S	Hour Meter
18	725-3163	1	S	Switch, Ignition
19	725-3164A	1	S	Switch, Interlock (Brake)
20	725-3166	1	S	Switch, Snap Mount - Normally Closed
21	725-3233	1	S	Switch, PTO
22	725-3166	1	S	Switch, Snap Mount Seat
23	725-3237	1		Cover, Terminal Red
24	736-0607	1	/P	Washer, External Lock, 5/16
25	729-0357	2		Holder, Fuse w/Mounting Clip
26	725-1707C	1	S	Battery
28	725-0157	4	/P	Tie, Self-Clinch Cable
29	726-0154	9	S	Tie, Pushmount
30	726-3055	9		Clip, Cable
31	726-0161	2		Clip, Wire

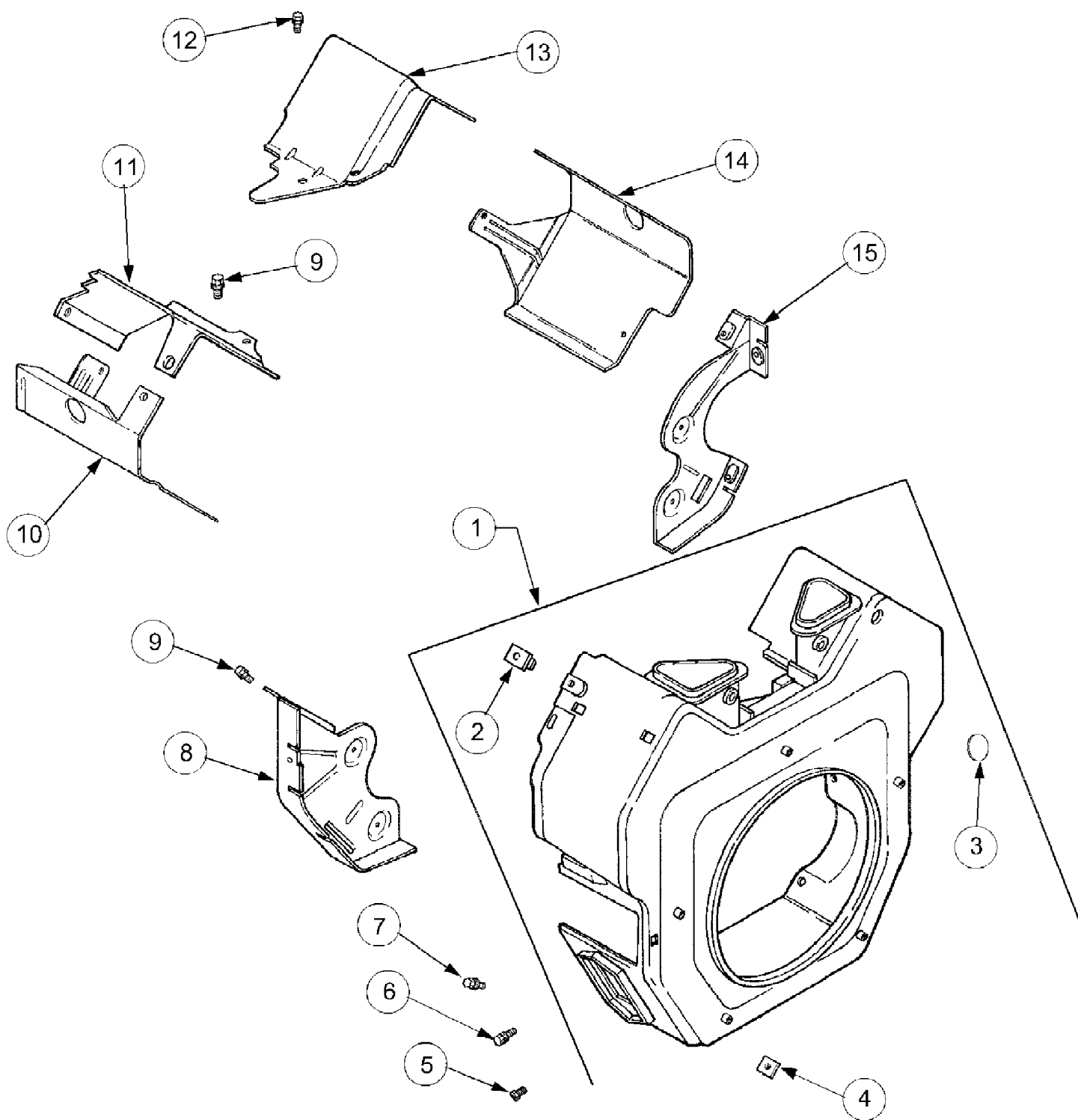

GT2186-48 Tractor
Blower Housing And Baffles

Page 6 of 76

Ref #	Part Number	Qty	S/P/F	Description
1	KH-24-027-175-S	1	/P	Housing, Blower (Incl. Ref #2-4)
2	KH-24-100-02	2		Nut, Plastic
3	KH-25-139-16	1		Plug, Button, 9/16
4	KH-24-100-01	3		Nut, Plastic
5	KH-M-0551016	1		Screw, Hex Flange, M5 x 0.8 x 16
6	KH-M-545016-S	3	/P	Screw, Hex Flange, M5 x 0.8 x 16
7	KH-M-0545020	4	/P	Screw, Hex Flange, M5 x 0.8 x 20
8	KH-24-146-16-S	1	/P	Plate, Backing - #2 Side
9	KH-M-0645016	6	S	Screw, Hex Flange, M6 x 1.0 x 16
10	KH-24-063-20	1	/P	Baffle, Cylinder Barrel - #2 Side
11	KH-24-063-17	1	/P	Baffle, Valley - #2 Side
12	KH-M-0545010	2	/P	Screw, Hex Flange, M5 x 0.8 x 10
13	KH-24-063-59-S	1		Baffle, Valley - #1 Side
14	KH-24-063-58-S	1	S	Baffle, Cylinder Barrel - #1 Side
15	KH-24-146-20-S	1	/P	Plate, Backing - #1 Side

GT2186-48 Tractor
Brake And Control Pedals

