

A-Frame Hitch Adapter-To Mt Yoke Type Implmt To Trctrs Eqp

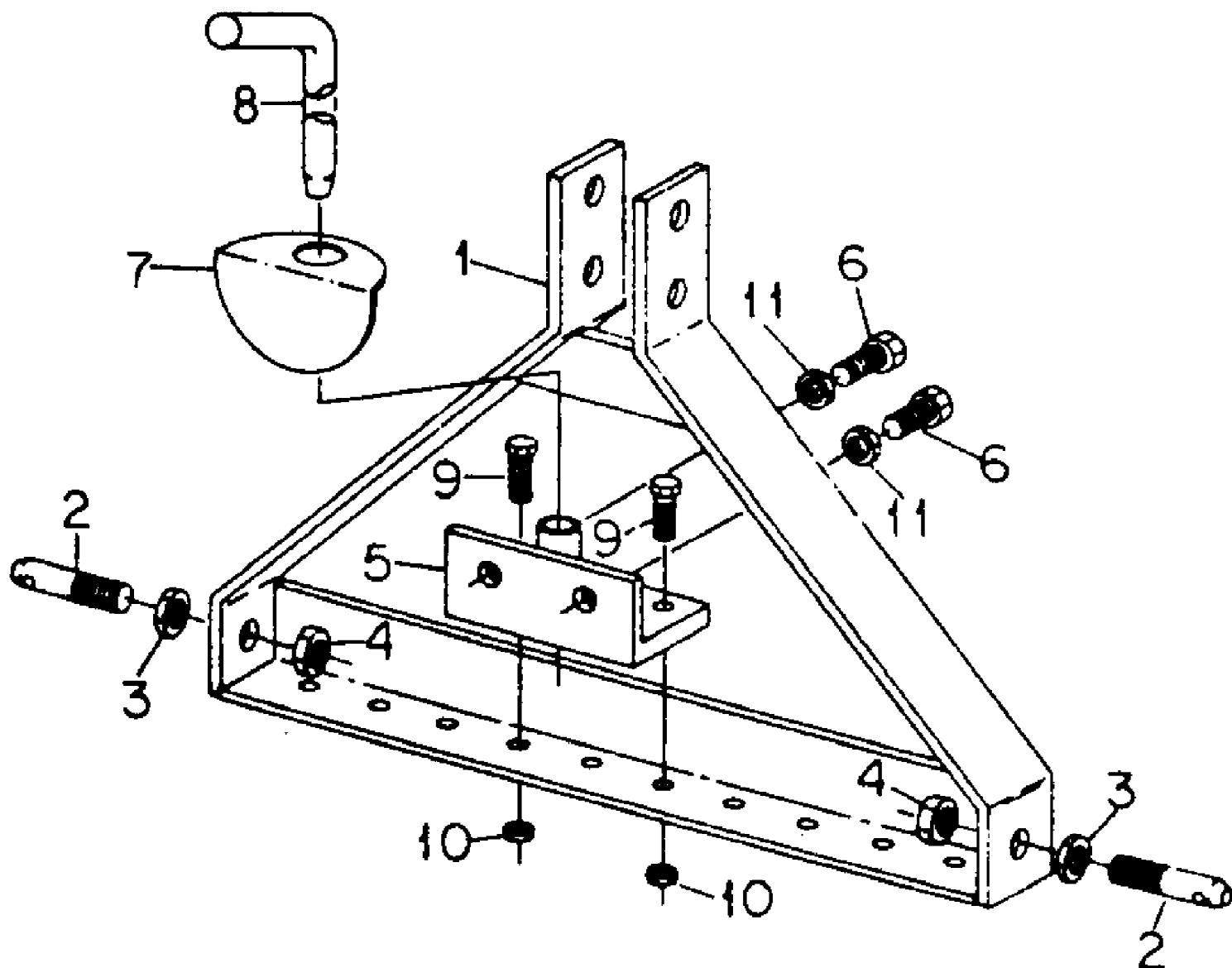

A-Frame Hitch Adapter-To Mt Yoke Type Implmt To Trctrs Eqp

Ref #	Part Number	Qty	S/P/F	Description
1		1		Adapter Pkg, Frame Hitch
2	IH-106998-C1	2		Pin
3	712-3015	2	S	Nut, 5/8 Jam Type 5
4		2		Nut, 5/8 Type 5 (Common Hardware, Purchase Locally)
5	~NLA	1		Adapter, Sleeve
6	BR-IM2032P	2		Bolt, 5/8 X 2 Type 5
7	BR-H-158	1		Plate, Stabilizer
8	BR-H-130P-01	1	S	Pin, Sleeve
9	710-3181	2	/P	Bolt, 1/2 X 1-1/2 Type 5
	736-0921	2	S	Washer, 1/2 Lock
10	712-0206	2	S	Nut, 1/2 Type 5
11	712-3015	2	S	Nut, 5/8 Jam Type 5
	BR-D-146P	2		Package, Quick Attachable Cotters

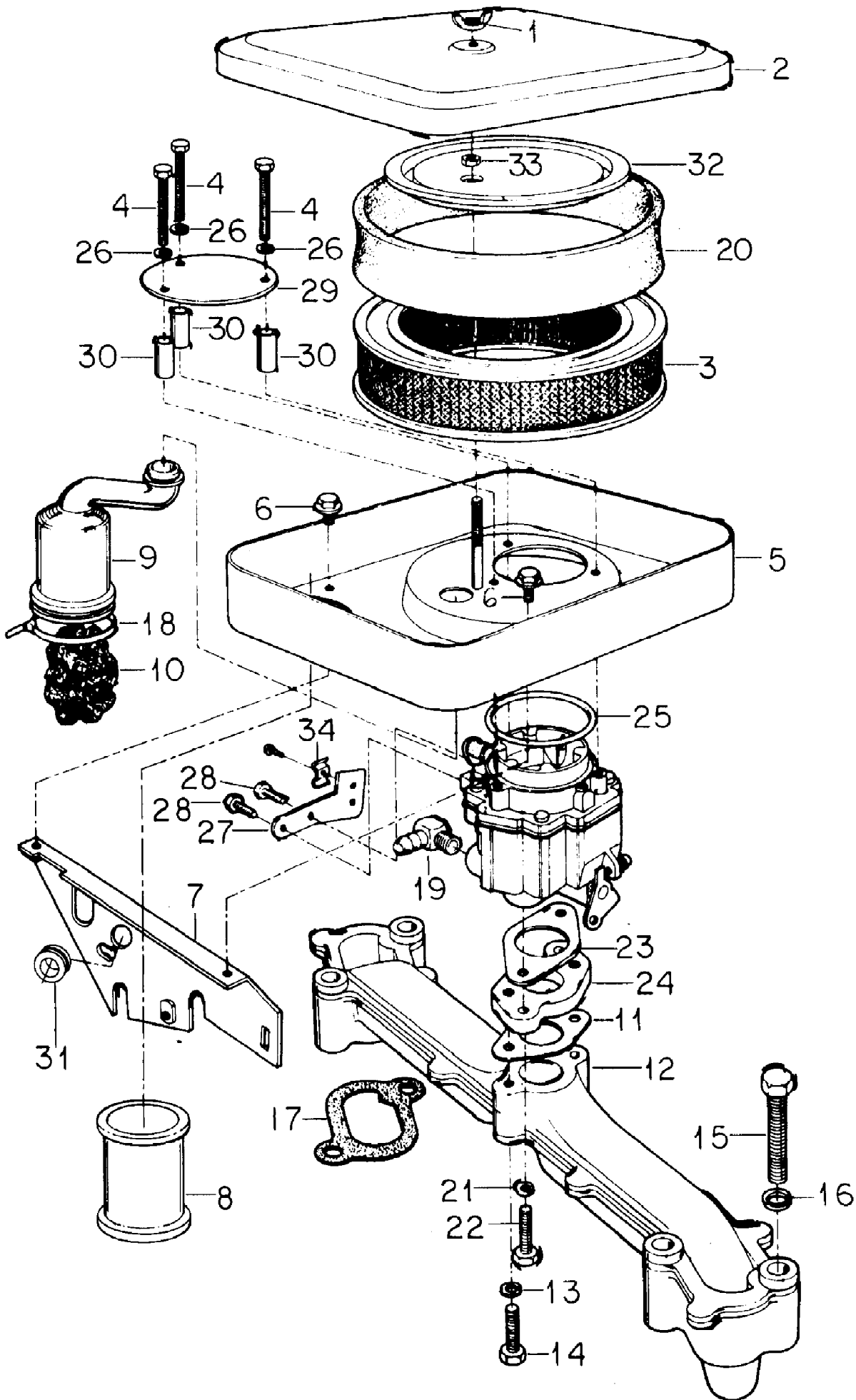

Air Cleaner & Intake Manifold

Ref #	Part Number	Qty	S/P/F	Description
1	712-3044	1		Nut, 1/4 Wing
2	ME-140-1663	1		Cover, Air Cleaner
3	ME-140-2522	1	S	Filter, Air
4	IH-78650-C1	3		Screw, Machine, #10-32 X 1-1/2
5	ME-140-1885	1		Housing, Air Cleaner
6	710-0776A	2	S	Screw, 1/4 X 1/2 Tap
7	ME-140-1961	1		Support, Air Cleaner
8	ME-140-1661	1		Tube, Air Intake
9	ME-123-1429	1	/P	Tube, Crankcase Breather
10	ME-123-1417	1		Filter, Breather Tube
11	ME-145-0438	1	/P	Gasket, Carburetor
12	ME-541-0275	1	S	Manifold, Intake OR
	ME-154-2720	1	S	Manifold, Intake
13	736-0329	2	S	Washer, 1/4 Lock
14		2		Bolt, 1/4 X 1-3/8 Type 5 (Common Hardware, Purchase Locally)
15	710-3103	4	/P	Bolt, 5/16 X 2 Type 5
16	736-0119	4	S	Washer, 5/16 Lock
17	ME-154-2495	2	/P	Gasket, Manifold to Block
18	ME-332-0941	1		Tie, Breather Tube
19	ME-502-0313	1		Elbow, Adapter
20	ME-140-1496	1	S	Element, Air Filter Pre-Cleaner
21	736-0119	2	S	Washer, 5/16 Lock
22	710-3038	2	/P	Bolt, 5/16 X 7/8 Type 5
23	ME-154-0733	1	/P	Gasket, Carb to Adapter
24	ME-154-1977	1		Adapter, Carb Mounting
25	ME-509-0145	1		O-Ring, Carb Air Inlet
26	736-0722	3	S	Washer, No. 10 Lock
27	ME-153-0515	1		Bracket, Choke Cable
28	ME-821-0002	2		Screw, 10-32 X 1/4 Cap
29	ME-145-0521	1		Plate, Carb Air Deflector
30	ME-140-1686	3		Spacer, Deflector Plate
31	ME-508-0021	1		Grommet, Rubber
32	ME-140-1692	1		Cover, Element
33	712-3006	1	/P	Nut, 1/4 Type 5
34	ME-153-0514	1		Clip, Choke Cable

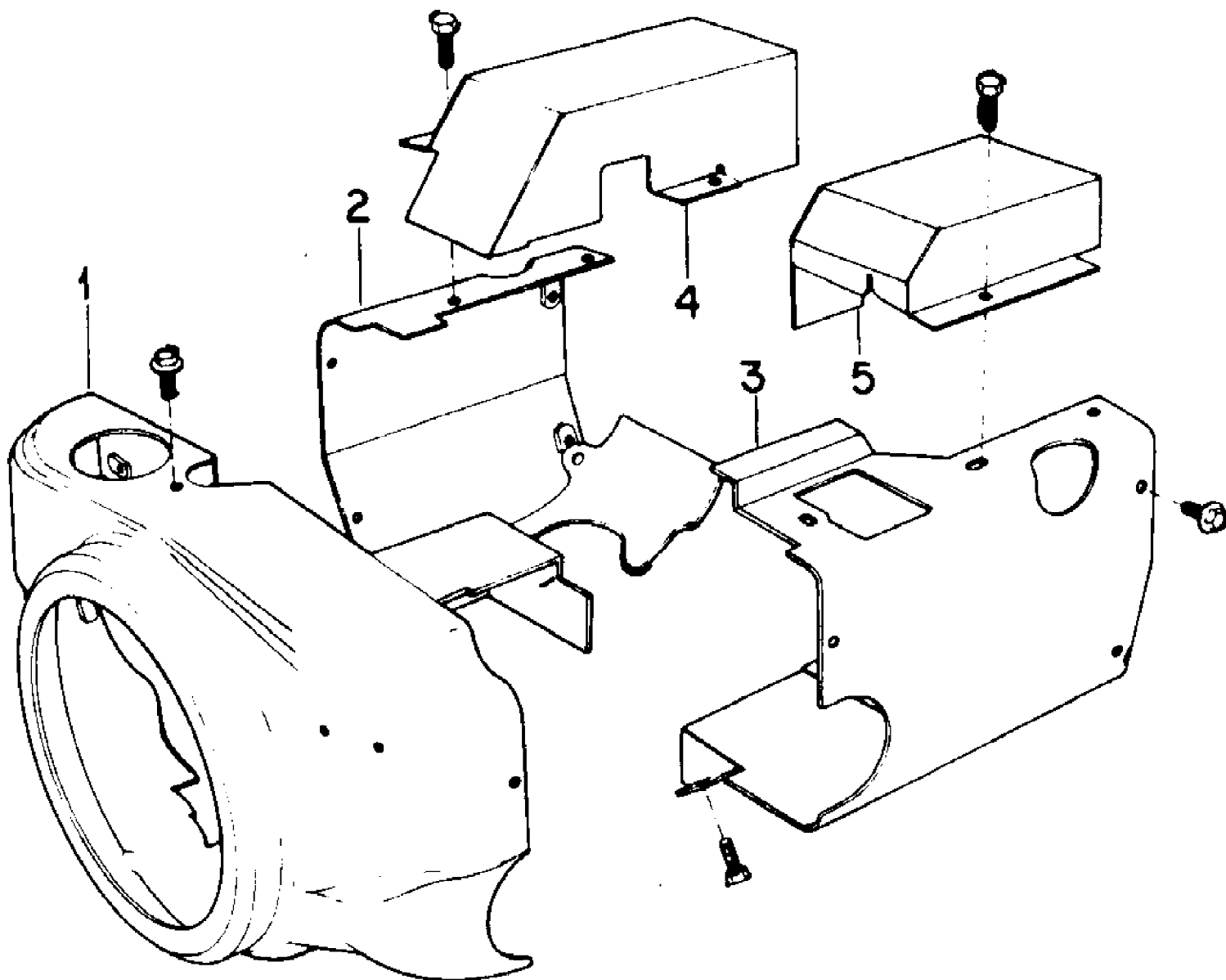

984
Blower Housing

Page 6 of 128

Ref #	Part Number	Qty	S/P/F	Description
1	ME-134-4288	1		Housing, Blower
		2		Bolt, 1/4 X 3/8 Type 5 (Common Hardware, Purchase Locally)
2	ME-134-3803	1		Housing, Cylinder Air, LH
3	ME-134-3800	1		Housing, Cylinder Air, RH
	710-0751	2	/P	Bolt, 1/4 X 5/8 Type 5
	736-0463	2	S	Washer, .281 X .625 X .051
	710-0776A	1	S	Screw, 1/4 X 1/2 H/Whd Tap
4	703-0250	1		Cover, Exhaust Tube, LH
5	703-0252	1		Cover, Exhaust Tube, RH
	ME-821-0008	4		Screw, 1/4-20 X 5/16 Hex Flg Lock
	710-3004	2	S	Screw, 5/16 X 3/4 H/Hd Tap
	ME-526-0018	2		Washer, Flat

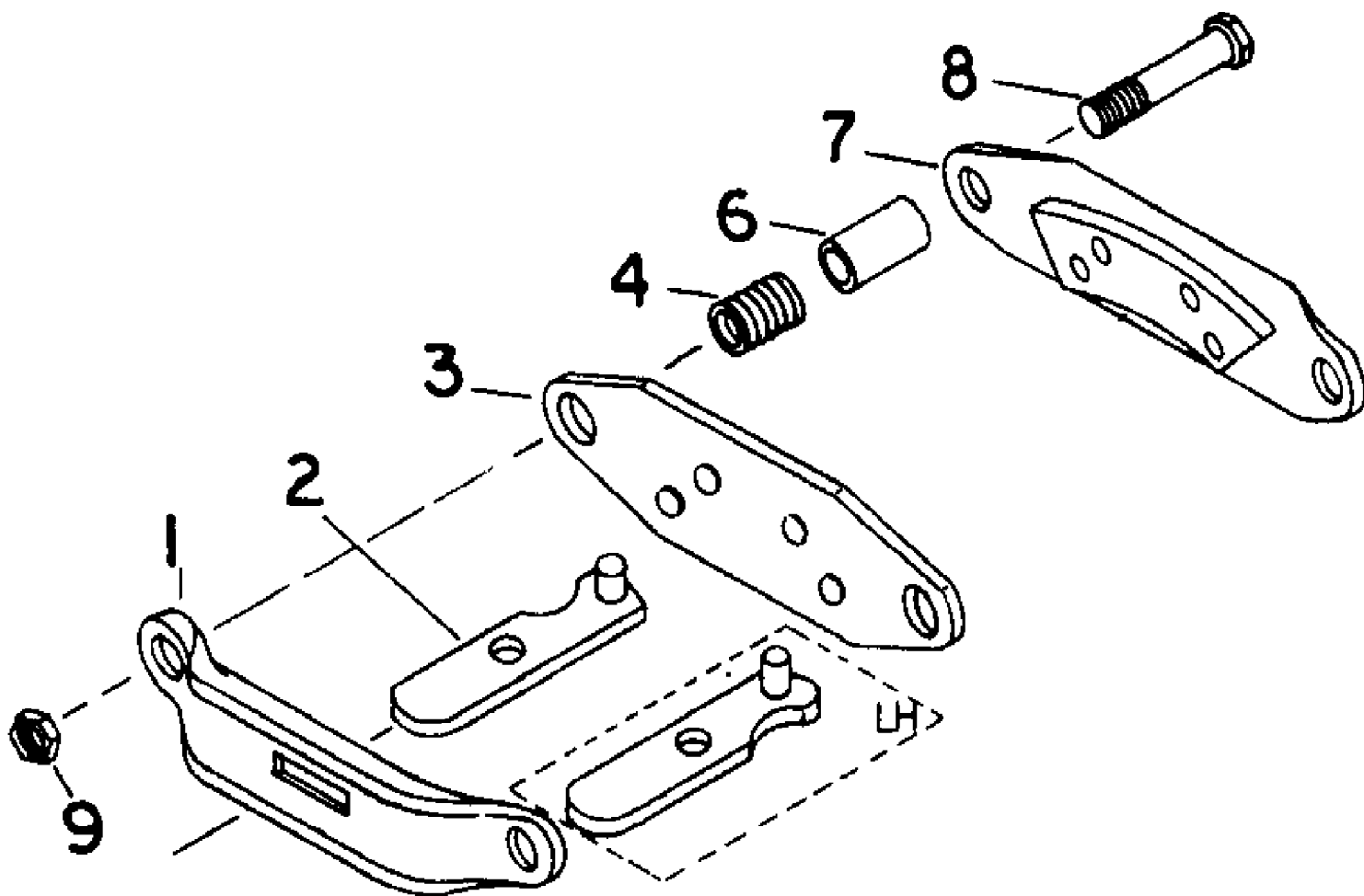

Ref #	Part Number	Qty	S/P/F	Description
	761-3003	1		Brake Assembly
1	~NLA	1		Bracket, Cam Actuator
2	IH-223384-C2	1		Cam
3	IH-223385-C2	1		Plate, Flat Pad Holder
4	IH-223388-C1	2		Spring
6	IH-223389-C2	2		Bushing
7	IH-223386-C3	2		Plate, Ribbed Pad Holder
	IH-37508-D	16		Rivet, 9/64 X 3/8 Brs Pln 150D C/Hd S/T
8	710-0331	2	/P	Bolt, 3/8-NF X 2-1/4 Type 5
9	712-0214	2	S	Nut, 3/8-NF P/T Lock Type 5

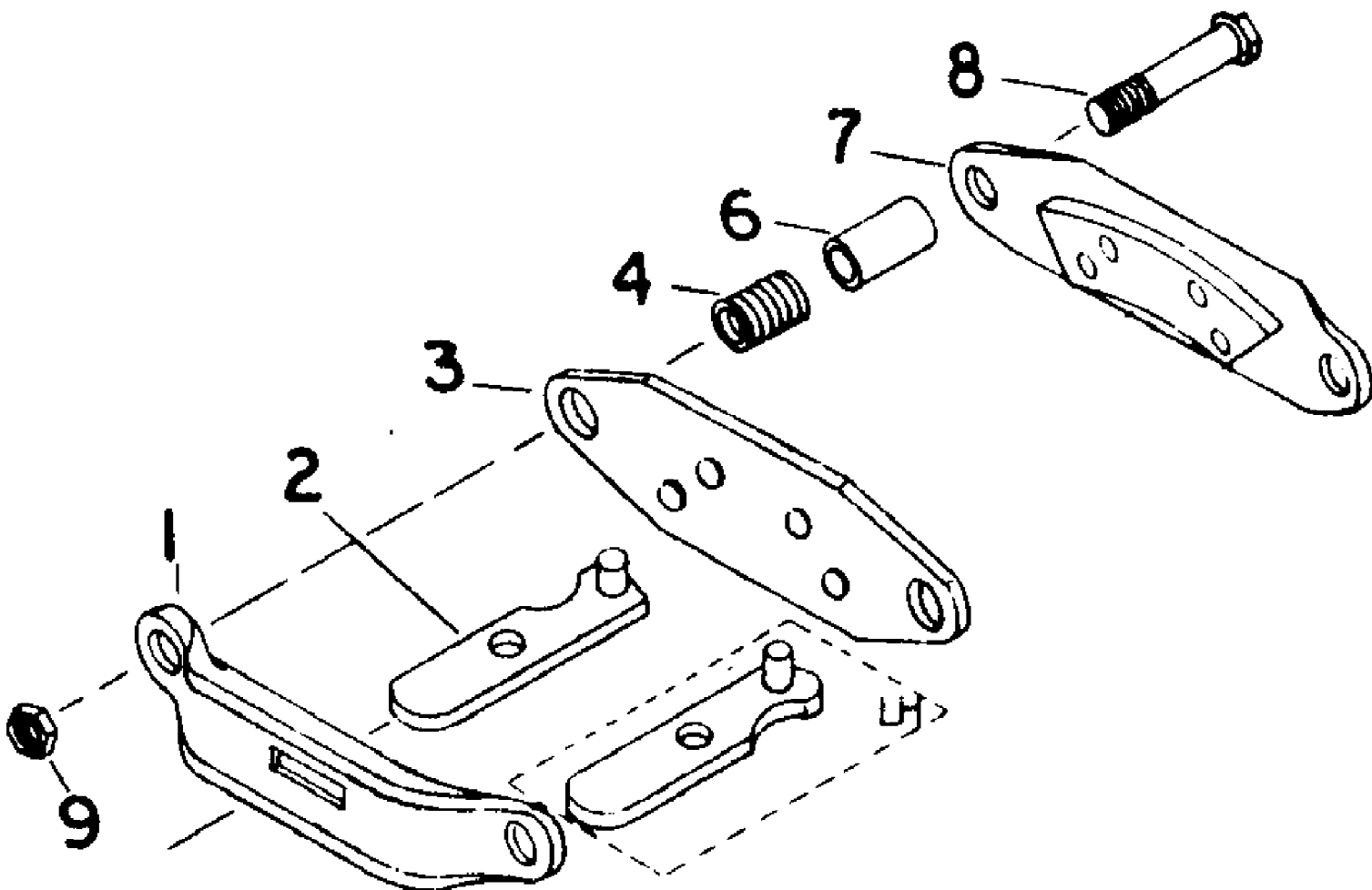

Ref #	Part Number	Qty	S/P/F	Description
	IH-106904-C91	1		Caliper Assy, Brake
1	~NLA	1		Bracket, Cam
2	IH-223384-C2	1		Cam
3		1		Plate, Flat Pad Holder (Furnish Relining Kit IH-107148-C91)
4	IH-223388-C1	2		Spring, Compression
6		2		Bushing (Furnish Relining Kit IH-107148-C91)
7		1		Plate, Ribbed Pad Holder (Furnish Relining Kit IH-107148-C91)
	IH-37508-D	8		Rivet, 9/64 X 3/8 Brs Pln 150D C/Hd S/T
8	710-0331	2	/P	Bolt, 3/8-NF X 2-1/4 Type 5
9	712-0214	2	S	Nut, 3/8-NF P/T Lock Type 5
	IH-107148-C91	1		Kit, Brake Relining Plate Flat Pad Holder Plate, Ribbed Pad Holder Bushing