

7532 Tractor
3 Point Linkage

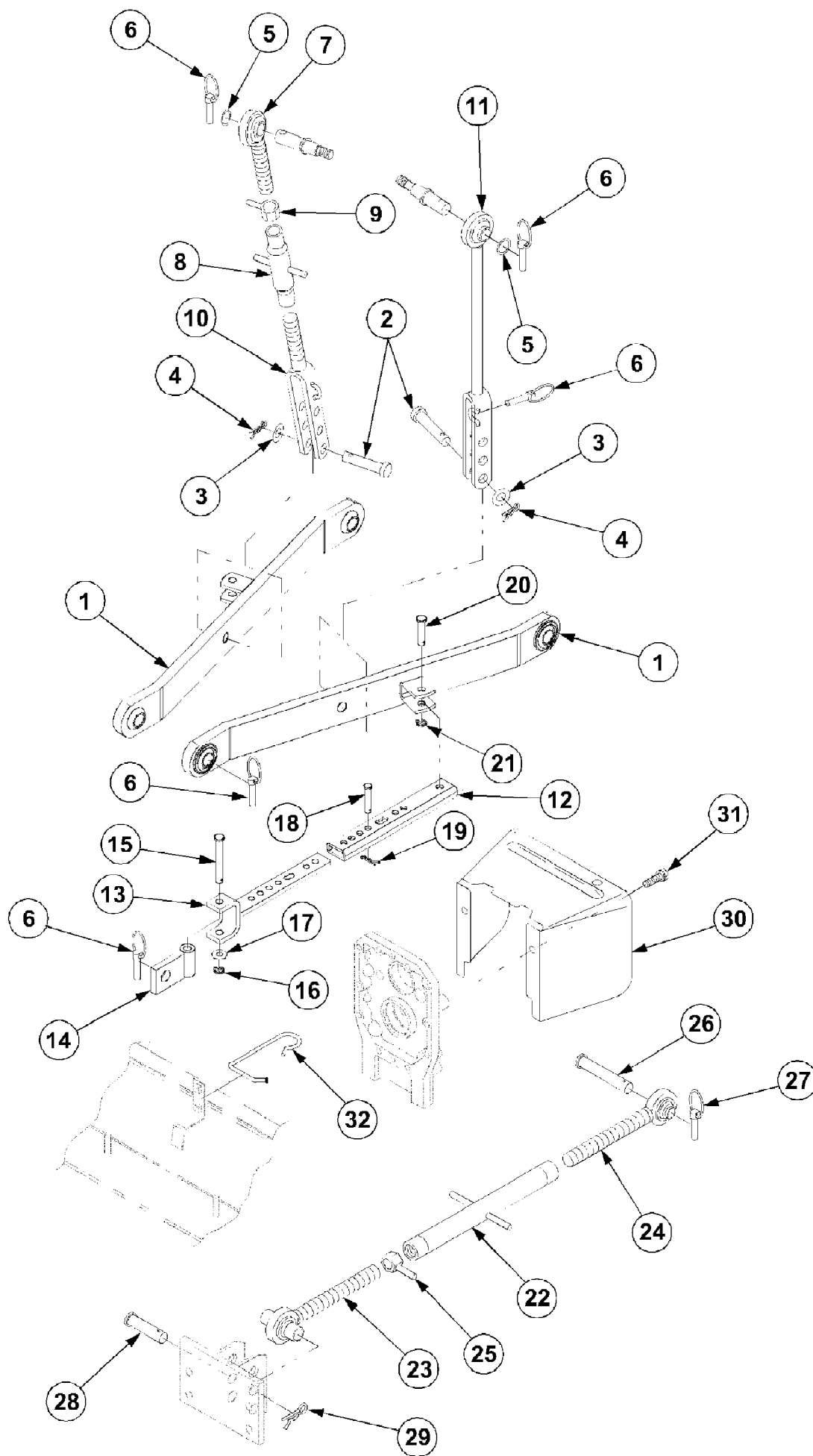

7532 Tractor
3 Point Linkage

Page 2 of 159

Ref #	Part Number	Qty	S/P/F	Description
1	MA-19573016AG0	2		Link,Lower
2	MA-10323018001	2	/P	Pin
3	MA-10323015000	2		Washer
4	MA-10323019000	2		Pin,Snap
5	MA-10323016000	2		Washer
6	MA-10323012000	8		Pin,Linch
	MA-19643011AG0	1	/P	Lift Rod RH Ass Includes 7-10
	MA-19643020000	1		Rod A Sub Assy Includes 7-9
7	MA-19643021000	1		Rod A
8	MA-19643022000	1	S	Lift Rod Middle
9	MA-19643024000	1	/P	Lock Nut
10	MA-19643014000	1	S	Rod B
11	MA-19643007AG0	1	/P	Lift Rod LH
	MA-19573020000	2	S	Stabilizer Assy Includes 12-19
12	MA-19573021000	2	S	Stabilizer,Rear
13	MA-19573022000	2	S	Stabilizer,Fron
14	MA-19693024000	2	S	Joint
15	MA-05621112090	2	S	Pin,Clevis
16	MA-05200130020	2		Pin,Split
17	MA-03500151226	2		Washer
18	MA-05621110050	2		Pin,Clevis
19	MA-05210110000	2		Pin,Snap
20	MA-05600112050	2		Pin,Wheel Tube
21	MA-05200130020	2		Pin,Split
	MA-19643036AG0	1		Top Link Assy Includes 22-25
22	MA-19643037000	1	S	Turn Buckle
23	MA-19643038000	1	S	Adjuster
24	MA-19643041000	1	S	Adjuster
25	MA-19643039000	1		Nut-Lock
26	MA-19633037000	1		Pin,Upper Link
27	MA-10323012000	1		Pin,Linch
28	MA-19633038000	1		Pin
29	MA-19633041000	1		Pin,Snap
30	MA-19633034AG0	1	S	Cover,PTO
31	MA-F1540112025	2		Bolt,w/Washer
32	MA-19633031000	1		Hook,Top Link

7532 Tractor
Accessory

Page 3 of 159

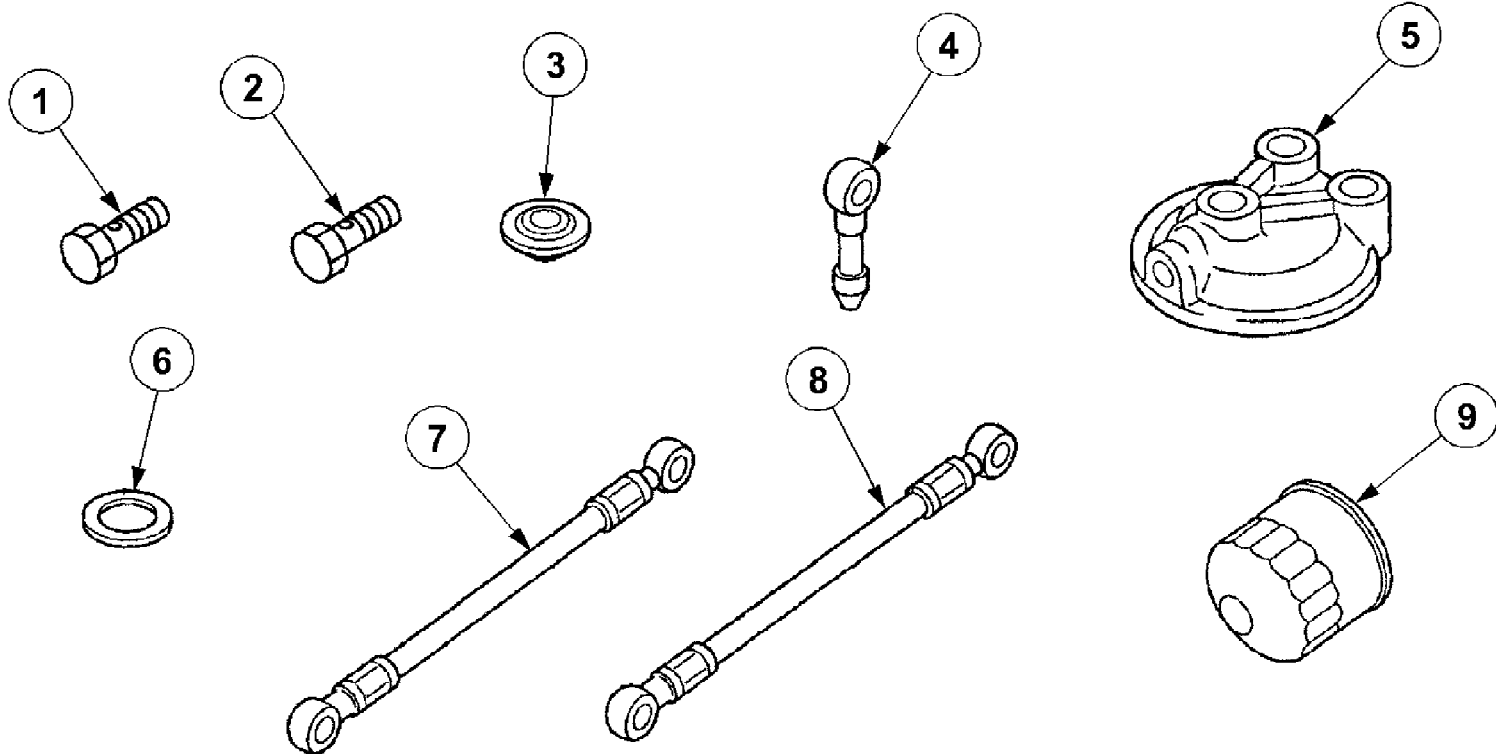

7532 Tractor
Accessory

Page 4 of 159

Ref #	Part Number	Qty	S/P/F	Description
1	MA-MF650102	1		Bolt, Eye
2	MA-MM100094	4		Bolt, eye
3	MA-05946-01001	2	S	Washer, Sealing
4	MA-30407-53900	1		Joint, Eye
5	MA-MM438183	1		Bracket, Oil
6	MA-05946-01601	8		Washer, Sealing
7	MA-30H36-10700	1		Tube Assy, Oil
8	MA-30H36-00600	1		Tube Assy, Oil
9	MA-MD162326	1		Filter Assy, Oil

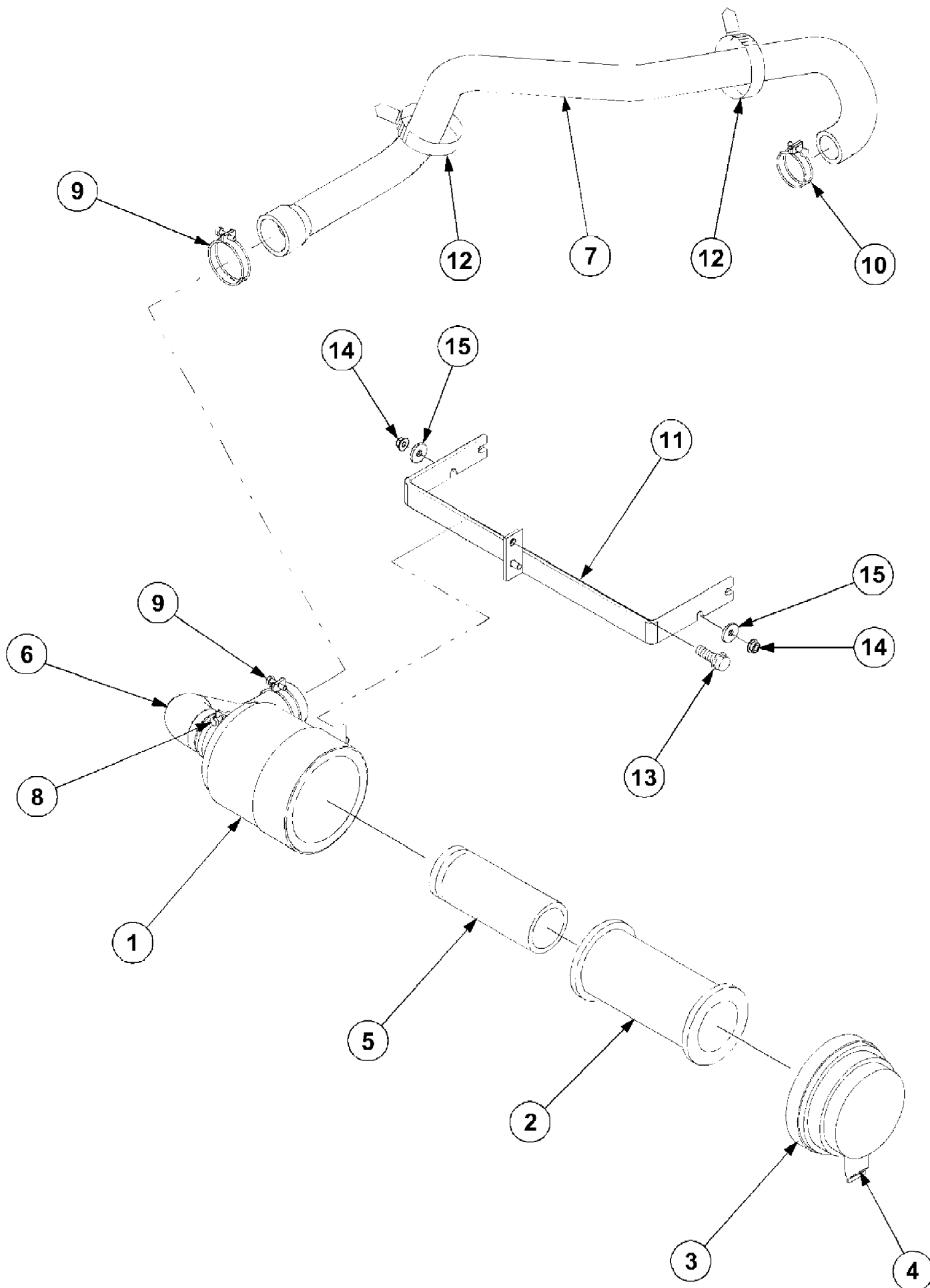

7532 Tractor
Air Cleaner

Ref #	Part Number	Qty	S/P/F	Description
	MA-19690531000	1		Air Cleaner Assembly Includes 1-5
1	MA-10400511100	1		Body Assy
2	MA-10400511200	1		Element Assy
3	MA-10400511300	1		Cover Assy
4	MA-35460501400	1		Valve,Unloader
5	MA-19690531100	1		Element,Inner
6	MA-19570512000	1		Hose,Air
7	MA-19560512000	1		Hose,Air
8	MA-00501100630	1		Clamp,hose
9	MA-00501100600	2		Clamp Hose
10	MA-00501100480	1		Clamp,hose
11	MA-19570515000	1	S	Bracket
12	MA-00511070070	2		Band,Wire
13	MA-H1540108020	1		Bolt,w/Washer
14	MA-F3010108000	4		Nut,Flange
15	MA-03500160826	4		Washer

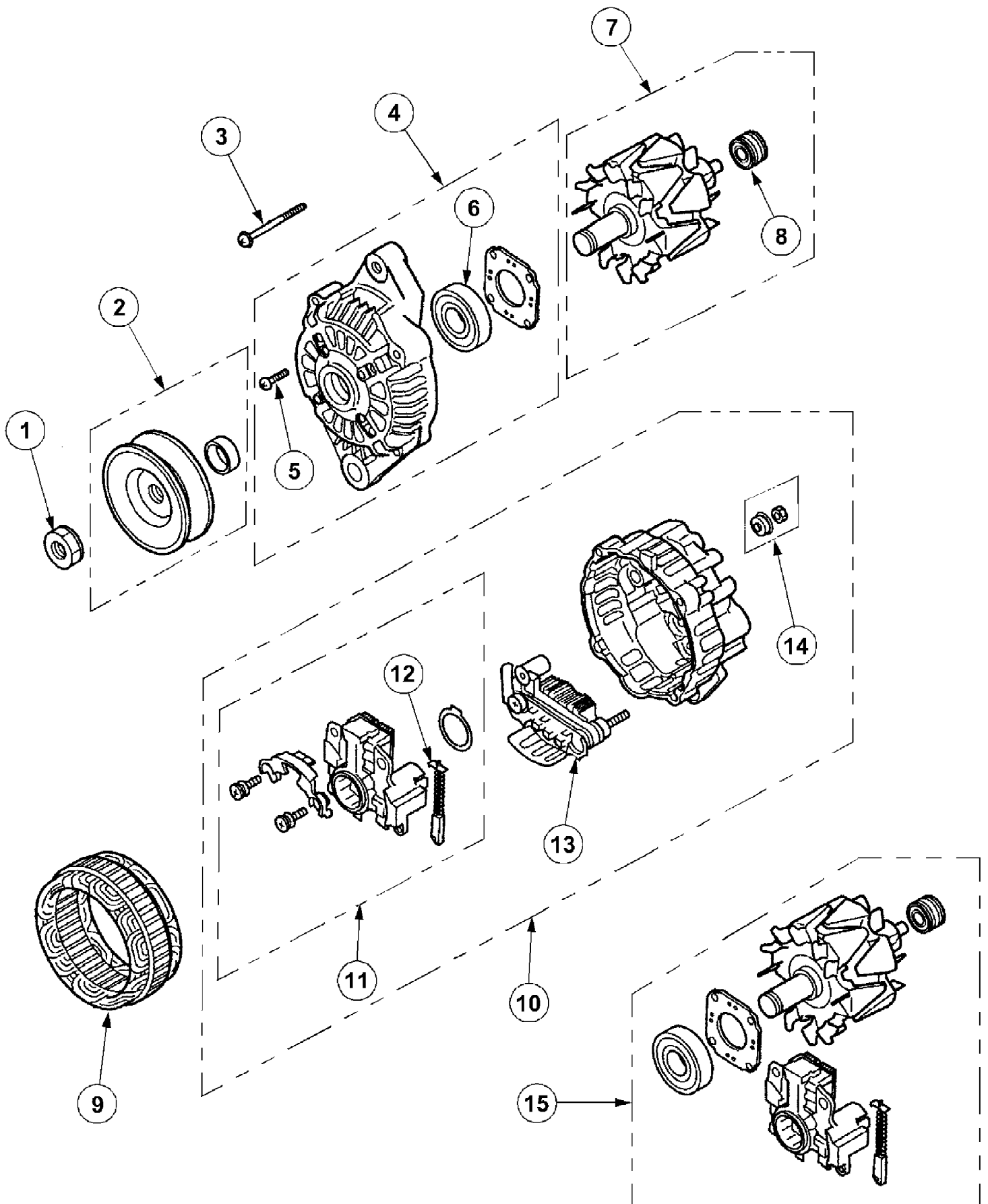

7532 Tractor
Alternator

Page 8 of 159

Ref #	Part Number	Qty	S/P/F	Description
	MA-31A68-00402	1	/P	Alternator Ass'y
1	MA-A981X-20771	1		Nut Set
2	MA-A628T-62170	1		Pulley Ass'y
3	MA-A414X-19271	1		Bolt Set
4	MA-A640X-67070	1	S	Bracket Ass'y
5	MA-A414X-21271	1		Screw Set
6	MA-A930X-94570	1		Bearing,Front
7	MA-A880X-83770	1		Rotor Ass'y
8	MA-S930P-63670	1		Bearing,Rear
9	MA-A383X-56570	1	S	Starter Ass'y
10	MA-A642X-A9970	1	S	Bracket Ass'y
11	MA-A866X-44682	1		Regulator Set
12	MA-A647X-50170	2		Brush Set
13	MA-A860T-40670	1		Rectifier Ass'y
14	MA-A529X-07871	1		Nut Set
15	MA-MM409897	1		Service Kit

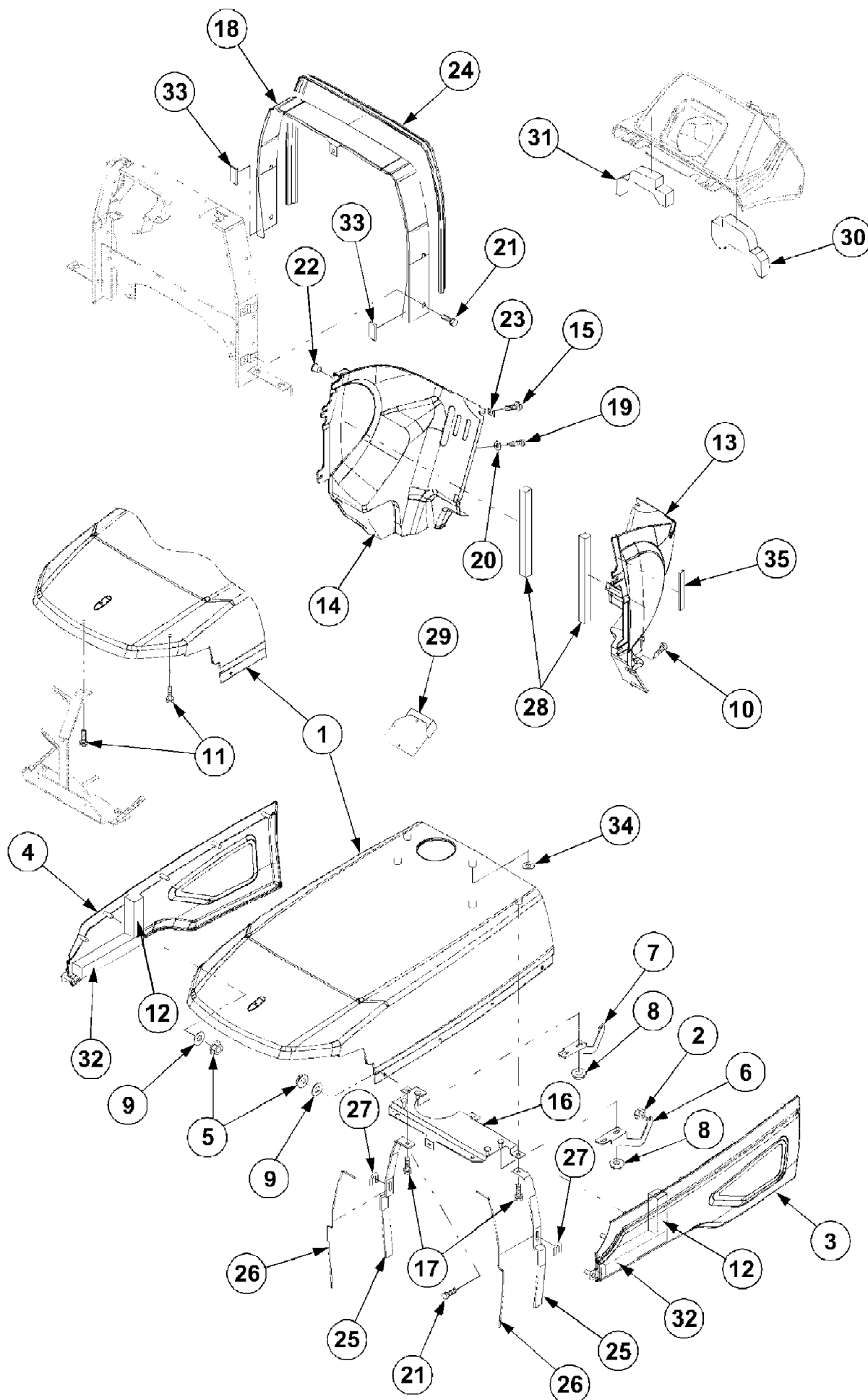

7532 Tractor
Bonnet (Part 1)

Ref #	Part Number	Qty	S/P/F	Description
1	MA-19572631000	1		Hood,Bonnet
2	MA-A3810108000	1		Nut
3	MA-19562621BC0	1		Cover,Side L.H
4	MA-19562622BC0	1		Cover,Side R.H
5	MA-F3000106001	12		Nut,Flange
6	MA-19562677000	1	S	Plate L.H
7	MA-19562678000	1	S	Plate R.H
8	MA-F3010108001	4		Nut,Flange
9	MA-03500140618	12		Washer
10	MA-10406313000	2		Clip
11	MA-H1540108016	3		Bolt,w/Washer
12	MA-19572624000	2		Cushion
13	MA-19572642000	1		Panel,Rear L.H
14	MA-19572643000	1		Panel,Rear R.H
15	MA-H1640406016	6		Bolt,w/Washer
16	MA-19562661000	1	S	Plate
17	MA-H1540108020	2		Bolt,w/Washer
18	MA-19562671BC0	1		Cover
19	MA-35180844000	2		Screw
20	MA-10442675000	2		Washer
21	MA-H1540108016	5		Bolt,w/Washer
22	MA-0553410000	1		Plug
23	MA-10442646000	1		Plate
24	MA-19562681000	1		Weather Strip
25	MA-19562651000	2	S	Plate
26	MA-35187458000	2		Rubber
27	MA-36205314000	A/R	S	Liner
28	MA-19560424000	2		Cushion
29	MA-19562656001	1		Cushion
30	MA-19562657000	1		Cushion LH
31	MA-19562658000	1		Cushion RH
32	MA-19572621000	2		Cushion
33	MA-19562686000	2		Rubber
34	MA-03500140818	1		Washer
35	MA-35593838600	1		Cushion