

7233 Tractor
3-Point Linkage

Page 2 of 165

Ref #	Part Number	Qty	S/P/F	Description
1	MA-19643013AG0	1	/P	Bracket L.H.
2	MA-19643015AG0	1	/P	Bracket R.H.
3	MA-19643001AG0	1		Bracket L.H.
3A	MA-19643002AG0	1		Bracket R.H.
4	MA-A0400114035	12		Bolt
5	MA-A3600101402	12		Washer
	MA-19643005AG0	1		3P Sub Ass'y. Includes items 6-42
6	MA-19643006AG0	2		Link, Lower
7	MA-19643007AG0	1	/P	Rod, Lift L.H.
	MA-19643011AG0	1	/P	Rod, Lift R.H. Ass'y. Includes items 9-12
9	MA-19633012AG0	1	/P	Rod A
?10	MA-10323025AG0	1	/P	Lift Rod Middle
11	MA-19643014AG0	1	/P	Rod B
12	MA-10323024000	1	S	Nut, Lock
	MA-19643016001	2		Check Chain Ass'y. Includes items 14-17
14	MA-19643017000	2		Chain A
15	MA-19643018000	2		Chain B
16	MA-10323027001	2		Turn Buckle
17	MA-A3000114002	2		Nut
20	MA-19643019AG0	2		Washer, Check Chain
21	MA-A3600101802	2	/P	Washer
22	MA-A3030118001	2		Nut
23	MA-19633021000	2		Pin, Clevis
24	MA-05200130020	2		Pin, Split
26	MA-10323018001	2	/P	Pin
27	MA-10323019000	2		Pin Snap
28	MA-19633024000	1		Band
29	MA-10323012000	6		Pin, Linch
30	MA-10323016000	2		Washer
	MA-19643036AG0	1		Top Link Ass'y. Includes items 32-35
32	MA-19643037AG0	1	/P	Turn Buckle
33	MA-19643038AG0	1	/P	Adjuster
34	MA-19643039000	1		Nut - Lock
35	MA-19643041AG0	1	/P	Adjuster
38	MA-19633037000	1		Pin, Upper Link
39	MA-10323012000	1		Linch Pin
41	MA-19633038000	1		Pin
42	MA-19633041000	1		Pin, Snap
44	MA-19633031000	1		Hook, Top Link
45	MA-19633034AG0	1	S	Cover PTO
46	MA-F1540112025	2		Bolt

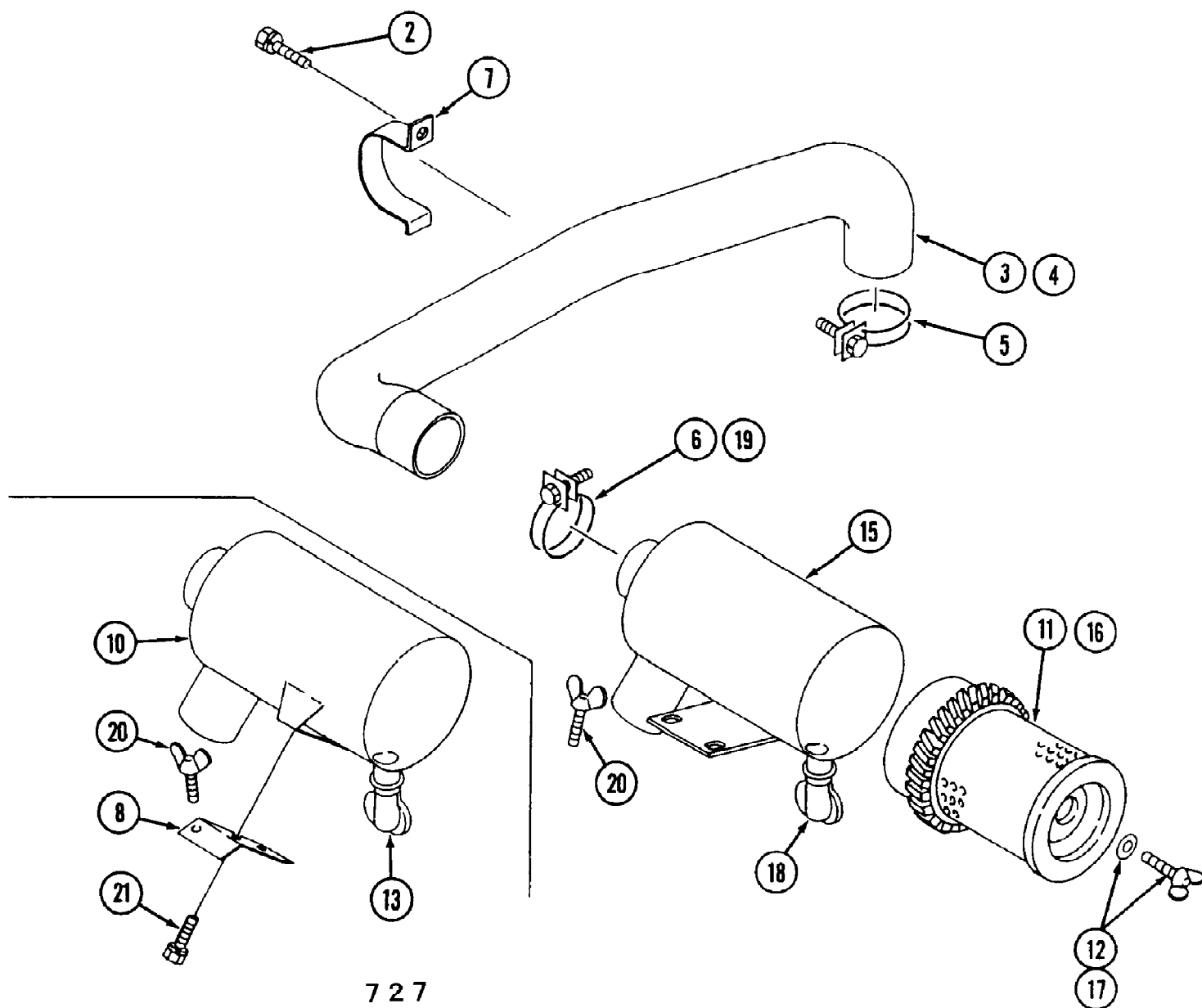

7233 Tractor
Air Cleaner

Ref #	Part Number	Qty	S/P/F	Description
2	MA-F1540108020	1		Bolt
3	MA-19640512000	1		Hose, Air
4		0		Hose, Air Not used on this model
5	MA-00501100530	1		Band, Hose
6		0		Band, Hose Not used on this model
7	MA-19630513000	1		Clamp
8		0		Plate Not used on this model
		0		Air Cleaner Not used on this model
10		0		Case Ass'y. Not used on this model
11		0		Element Not used on this model
12		0		Bolt, Ass'y., Wing Not used on this model
13		0		Valve Not used on this model
	MA-19630511000	1		Air Cleaner Includes items 15-18
15	MA-10320521100	1		Case Ass'y.
16	MA-10300511200	1		Element
17	MA-36610304000	1		Bolt Ass'y., Wing
18	MA-10300511300	1		Valve
19	MA-00501100560	1		Band, Hose
20	MA-14141454000	1		Bolt
21		0		Bolt Not used on this model

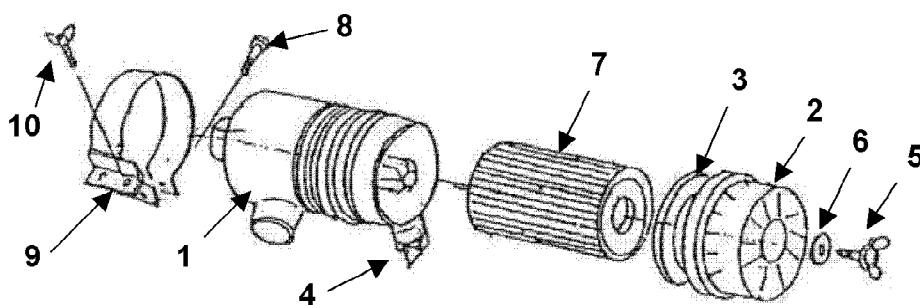

7233 Tractor
Air Cleaner MA-19670511000

Ref #	Part Number	Qty	S/P/F	Description
	MA-19670511000	1		Air Cleaner Assembly MA-19670511000 Air Cleaner Assembly replaces MA-19630511000 when inventory is depleted. All components will change if the air cleaner assembly is replaced. Inventory depletion of component parts for the MA-19630511000 will also necessitate replacement with the MA-19670511000. Refer to Service Adviso
1	MA-19670511100	1		Case (plastic)
2	MA-35460501200	1		Cap
3	MA-35460501300	1		Gasket
4	MA-35460501400	1		Dirt Unloader Valve
5	MA-35460501500	1		Bolt Ass'y
6	MA-35460501600	1		Seal Washer
7	MA-35460501800	1		Element
8	MA-F1540108030	1		Bolt
9	MA-19670512AG0	1		Band
10	MA-14141454000	1		Wing Bolt

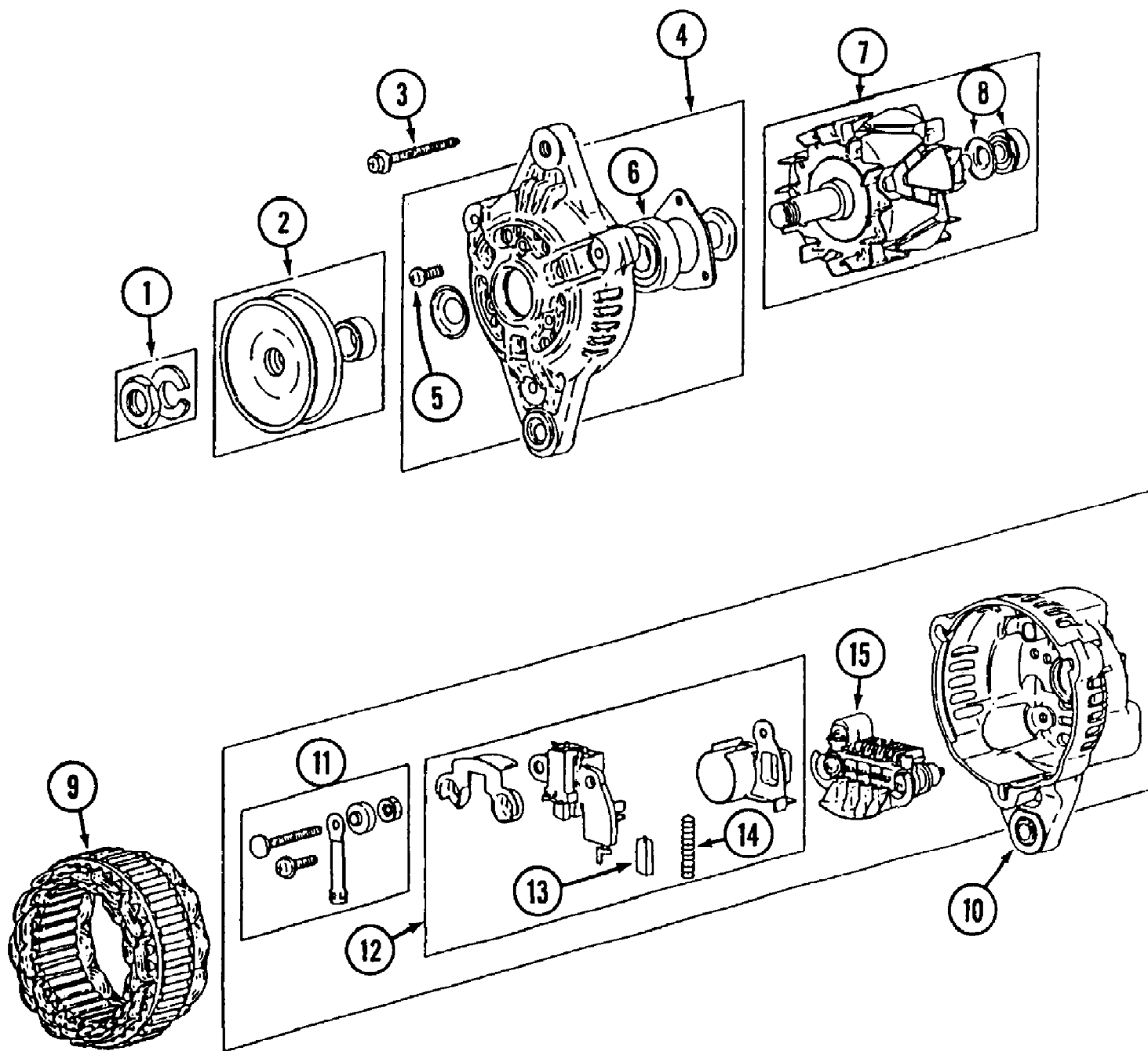

7233 Tractor
Alternator

Page 8 of 165

Ref #	Part Number	Qty	S/P/F	Description
	MA-MM435752	1		Alternator Ass'y.
1	MA-MM502340	1		Nut Set
2	MA-MM502508	1		Pulley Set
3	MA-MD607963	1		Bolt Set
4	MA-MM502504	1		Bracket Ass'y., Front
5	MA-MD611034	1		Screw Set
6	MA-MD611033	1		Bearing, Front
7	MA-MM502505	1		Rotor Ass'y.
8	MA-MD611150	1		Bearing, Rear
9	MA-MM502506	1		Starter Ass'y.
10	MA-MM502533	1		Bracket Ass'y., Rear
11	MA-MD607829	1		Terminal Set
12	MA-MM502532	1		Regulator Ass'y.
13	MA-MD611035	2		Brush
14	MA-MD602227	2		Spring, Brush
15	MA-MM502507	1		Rectifier Ass'y.

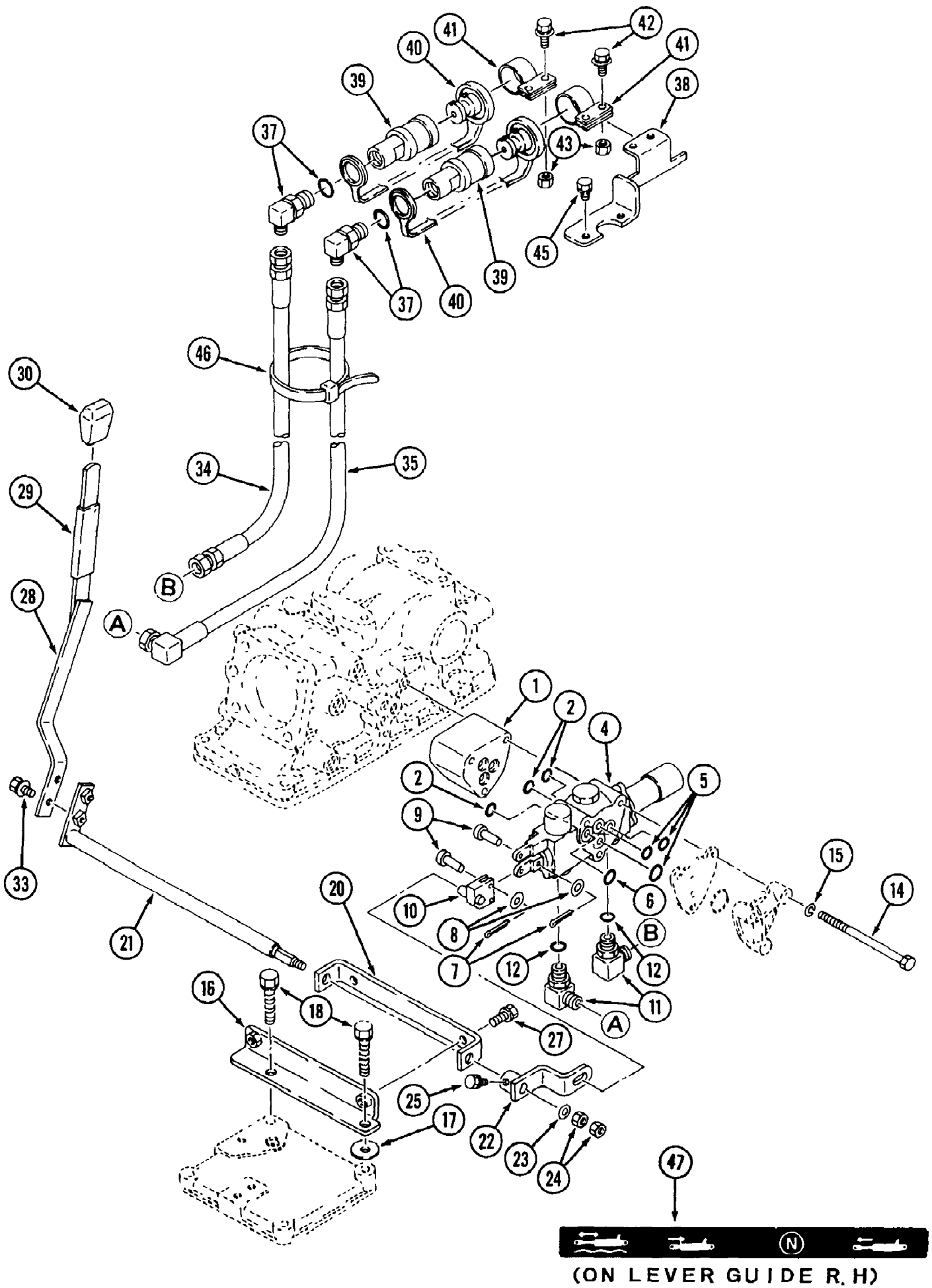

7233 Tractor
Auxiliary Valve Kit

Ref #	Part Number	Qty	S/P/F	Description
1	MA-19642481000	1		Spacer
2	MA-08301100120	3	/P	O-Ring
	MA-19632482AG0	1		Aux. Valve Ass'y.
4		1		Body
5	MA-08300100120	3	S	O-Ring
6	MA-08300100160	1	/P	O-Ring
7	MA-05200125016	3	S	Pin, Split
8	MA-03500130815	3		Washer
9	MA-11556501270	3		Pin, Clevis
10	MA-19642483000	1		Arm
11	MA-35231888100	2	F	Adapter Includes Ref #12
	MA-06313117170	1	F	Elbow 90 Includes Ref #12
12	MA-08300100140	2		O-Ring
14	MA-A0540108140	3		Bolt
15	MA-A3600100802	3		Washer
16	MA-19642484AG0	1		Bracket
17	MA-03500161032	1		Washer
18	MA-F1550110055	2		Bolt
20	MA-19642485AG0	1		Bracket
21	MA-19642486000	1		Shaft
22	MA-19642487000	1		Arm
23	MA-03500140818	1		Washer
24	MA-A3010108002	2		Nut
25	MA-A0500108012	1		Bolt
27	MA-F1540108020	2		Bolt
	MA-19642488AG0	1		Lever Ass'y.
28		1		Lever
29	MA-19632439000	1		Tube
30	MA-11742449000	1		Grip
33	MA-H1540108016	2		Bolt
34	MA-19642492000	1		Hose Ass'y.
35	MA-19642493000	1		Hose Ass'y.
37	MA-19632494000	2		Fitting
38	MA-19632496AG0	1		Bracket
39	727-3093	2	S	Coupling
40	731-3177	2		Plug/A
41	MA-12185264000	2		Clamp, Coupler
42	MA-H1540108020	4		Bolt
43	MA-F3010108001	4		Nut
45	MA-F1540108012	2		Bolt
46	MA-00511070070	1		Band, Wire
47	MA-19632753000	1		Label, Aux. Valve