

**9040 Excavator**

**Operators Manual**

**9-23810**







*THIS SAFETY ALERT SYMBOL INDICATES IMPORTANT SAFETY MESSAGES IN THIS MANUAL. WHEN YOU SEE THIS SYMBOL, CAREFULLY READ THE MESSAGE THAT FOLLOWS AND BE ALERT TO THE POSSIBILITY OF PERSONAL INJURY OR DEATH.*

M171B

If Safety Decals on this machine use the words **Danger, Warning or Caution**, which are defined as follows:

- **DANGER:** Indicates an immediate hazardous situation which if not avoided, will result in death or serious injury. The color associated with Danger is RED.
- **WARNING:** Indicates an potentially hazardous situation which if not avoided, will result in serious injury. The color associated with Warning is ORANGE.
- **CAUTION:** Indicates an potentially hazardous situation which if not avoided, may result in minor or moderate injury. It may also be used to alert against unsafe practices. The color associated with Caution is YELLOW.

If Safety Decals on this machine are ISO two panel Pictorial, decals are defined as follows:

- The first panel indicates the nature of the hazard.
- The second panel indicates the appropriate avoidance of the hazard.
- Background color is YELLOW.
- Prohibition symbols such as   and  if used, are RED.



# WARNING

IMPROPER OPERATION OF THIS MACHINE CAN CAUSE INJURY OR DEATH. BEFORE USING THIS MACHINE, MAKE CERTAIN THAT EVERY OPERATOR:

- Is instructed in safe and proper use of the machine.
- Reads and understands the Manual(s) pertaining to the machine.
- Reads and understands ALL Safety Decals on the machine.
- Clears the area of other persons.
- Learns and practices safe use of machine controls in a safe, clear area before operating this machine on a job site.

It is your responsibility to observe pertinent laws and regulations and follow Case Corporation instructions on machine operation and maintenance.

## GENERAL TABLE OF CONTENTS

To the Owner of a Case Machine .....	2
Identification Numbers/Machine Components .....	3
Safety/Decals/Hand Signals.....	5
Instruments and Controls.....	22
Operating Instructions.....	44
Tracks.....	63
Lubrication/Maintenance Charts .....	66
Lubrication/Filters/Fluids .....	73
Maintenance and Adjustments .....	106
Electrical System.....	109
Specifications .....	112
Machine Storage.....	124
After Delivery Check.....	127
Index.....	130

## TO THE OWNER

Read this manual before you start the engine or operate the machine. Failure to do so can result in personal injury or equipment damage. If you need more information, see your Case dealer.

Your dealer can give you assistance with J I Case Company approved service parts and information. Specially trained J I Case technicians, who know the best methods of repair and maintenance, are available for your machine.



Your Authorized Case Dealer

TO THE OWNER \_\_\_\_\_

## RIGHT, LEFT, FRONT, AND REAR SIDES OF THE MACHINE

Right-hand and left-hand, when used in this manual, indicate the right and left sides of the machine as seen from the operators seat. Before you drive the machine, make sure the drive sprockets are at the rear of the machine. See the following illustration for the correct TRAVEL position.

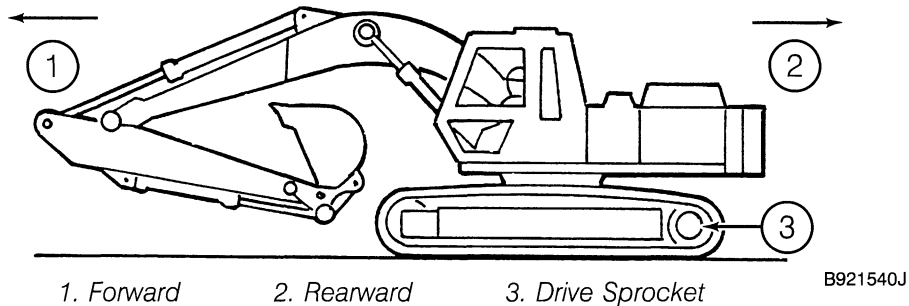

## IDENTIFICATION NUMBERS

Write the Product Identification Number (P.I.N.) and engine serial number on the lines provided below. If needed, give these numbers to your J I Case dealer when you need parts or information for your machine.

Make a record of the numbers. Keep the record and your Manufacturers Statement of Origin in a safe place. If the machine is stolen, report the numbers to your local law enforcement agency.

MACHINE MODEL NUMBER 9040

PRODUCT IDENTIFICATION NUMBER \_\_\_\_\_

ENGINE SERIAL NUMBER \_\_\_\_\_

### Product Identification Number

### Engine Serial Number

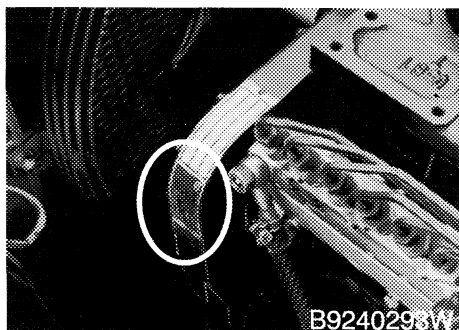
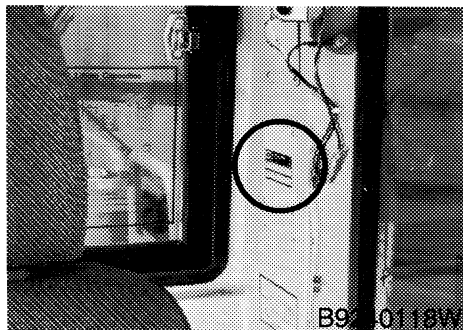

## MACHINE COMPONENTS

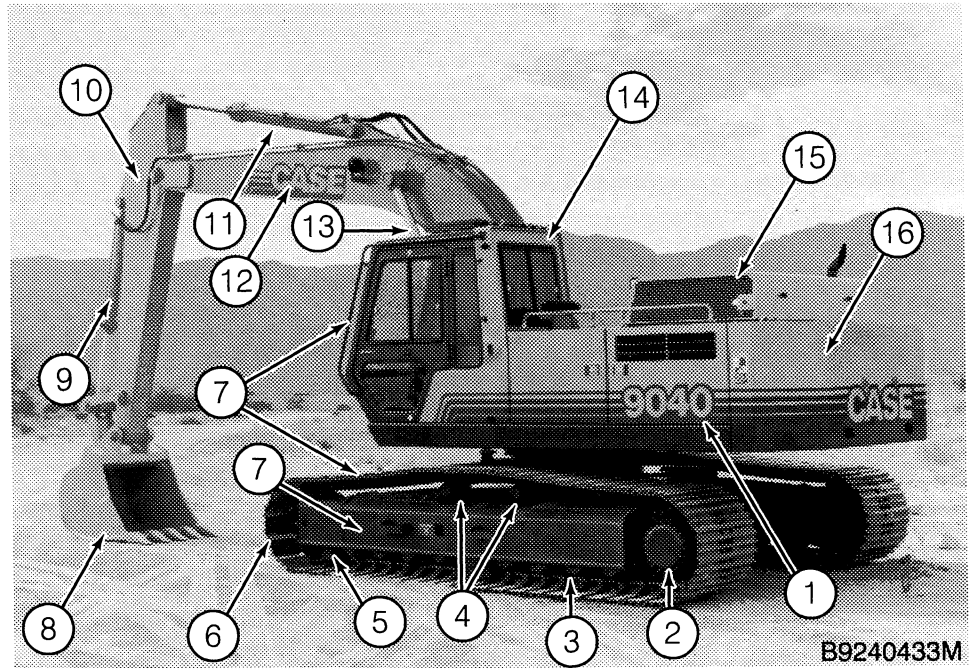

1. Upper Structure
2. Drive Sprocket
3. Track Rollers
4. Track Carrier Rollers
5. Idler
6. Track Chain
7. Hand Rails and Steps
8. Bucket

9. Bucket Cylinder
10. Arm
11. Arm Cylinder
12. Boom
13. Boom Cylinders
14. Operators Cab
15. Engine Compartment
16. Rear Counterweight

 **SAFETY RULES** 

Most accidents involving machine operation and maintenance can be avoided by following basic rules and precautions. Read and understand all the safety messages in this manual, the safety manual, and the safety signs on the machine before you operate or service the machine. See your J I Case dealer if you have any questions.

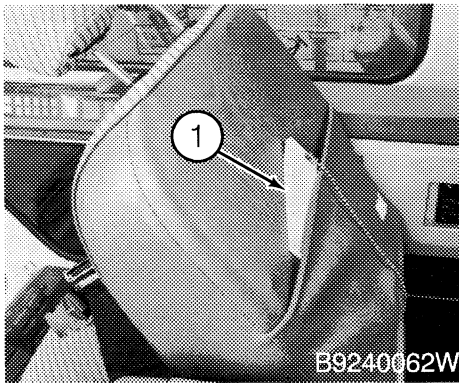

1. *Operators Manual Storage*

READ THIS MANUAL COMPLETELY and make sure you understand the characteristics of speed, stability, steering, and operation of this machine.

Do not remove this manual or the safety manual from the machine. See your J I Case dealer for additional manuals. Also see the inside of the rear cover of this manual for detailed information.

The safety information given in this manual does not replace safety codes, insurance regulations, or federal, state/provincial, or local laws. Make sure your machine has the correct equipment according to these rules or laws.

**IMPORTANT:** *Safety messages in this section point out situations which can be encountered during the normal operation and maintenance of your machine. These safety messages also give possible ways of dealing with these conditions.*

Additional safety messages are used in the text of the manual to indicate specific safety hazards.

 **BEFORE OPERATION** 

- Avoid loose fitting clothing, loose or uncovered long hair, jewelry and loose personal articles.
- Make sure that all windows are clean and that the windshield wipers work correctly.
- Different jobs will require different protective equipment. Items such as hard hats, protective shoes, heavy gloves, reflector type vests, respirators, ear protection, and eye protection can be required. Before you start the job, determine what protective equipment is required. Use this equipment at all times.
- Remove all loose objects from the operators area and cab. Loose objects can jam controls and cause accidents.
- Always face the machine and use the hand rails and steps when getting on or getting off. Do not rush.
- Be prepared for emergencies. Always have a first aid kit and a good working fire extinguisher with you and know how to use each.
- Know the hand signals used on your job. Follow the instructions of the flagman, signs, etc. See pages 19 and 20.
- Check that all doors, guards, and covers are installed correctly and/or closed.
- Foreign material or grease on the steps and hand rails can cause an accident. Keep the steps and hand rails clean.
- Stay away from hazardous areas such as ditches, overhangs, etc. Walk around the work area and look for hazards before you start.
- Before you operate at night, check that all lamps illuminate.





## SAFETY/DECALS/HAND SIGNALS

---

- Before you start each day, walk around the machine and check for oil or fluid leaks. Replace all broken or missing parts and do the required lubrication and maintenance as shown in this manual. Clean all trash and debris from the machine, especially from the engine area.
- Make sure all persons are away from the machine.
- Before you start the engine:
  1. Fasten your seat belt.
  2. Sound the horn to warn all persons that you are going to start the engine.
  3. Make sure the foot and hand controls are in NEUTRAL.
  4. Put the Control Switch in the OFF position.
  5. Put the Engine Throttle Control in the IDLE position.
  6. After the engine is started, put the Control Switch in the ON position.
- Engine exhaust fumes can cause death. If you operate this machine in an enclosed area, use good ventilation to replace the exhaust fumes with fresh air.
- Know the rules, laws, and safety equipment necessary for transporting this machine on a road or highway.

## SAFETY/DECALS/HAND SIGNALS

---



### MACHINE OPERATION



- Check all controls in a clear area and make sure the machine is operating correctly.

- Before you start, know the travel direction (drive sprockets at the rear of the machine).

- Do not allow other persons to ride anywhere on the machine. Other persons can fall or can cause an accident. This is a one person machine.

- Dust, fog, smoke, etc., can decrease or block your vision and cause an accident. Stop the machine or decrease the speed until you can see everything around you in your area. Make sure the machine lamps are ON.

- Contact with high voltage power lines, underground cables, etc., can cause serious injury or death from electrocution.

Before you drive or operate in an area with high voltage lines, cables, or power station, tell the power or utility company what you are going to do. You **MUST HAVE THE POWER DISCONNECTED OR KEEP A SAFE WORKING DISTANCE** from the lines, cables, or power station. You must know the safe working distance from the high voltage power equipment and must know any federal, state/provincial, or local safety codes or regulations that apply to the job site.

If a part of the machine touches high voltage power:

1. Warn other workers **NOT TO TOUCH THE MACHINE** and to stay away from the machine.

2. If you can break contact, reverse the operation that caused contact with the high voltage power, and move the machine away from the danger area. If you can not break contact, stay in the machine until the utility company de-energizes the line and tells you that the power is off.

3. If you have extreme conditions, such as a fire, etc., and you are forced to leave the machine, do not step off the machine. Jump as far from the machine as possible.

4. Then, hop away with your feet together until you are a safe distance from the machine and the electrical current. Do not take large steps. Because of the voltage differential across the ground, one foot can be in a higher voltage area than the other. This difference can kill you.

- Do not operate the machine if you do not feel well. This can be dangerous for you and for the people around you.

- Operate the machine smoothly. Do not make sudden starts or stops.

- If this machine rolls over, you can be injured or killed. You must make a judgment if weather, road, or earth conditions will permit safe operation on a hill, ramp, or rough ground.

- Stay away from hazardous areas such as ditches, overhangs, etc. Walk around the work area before you start and look for hazards. Do not dig a trench too close to the machine.