

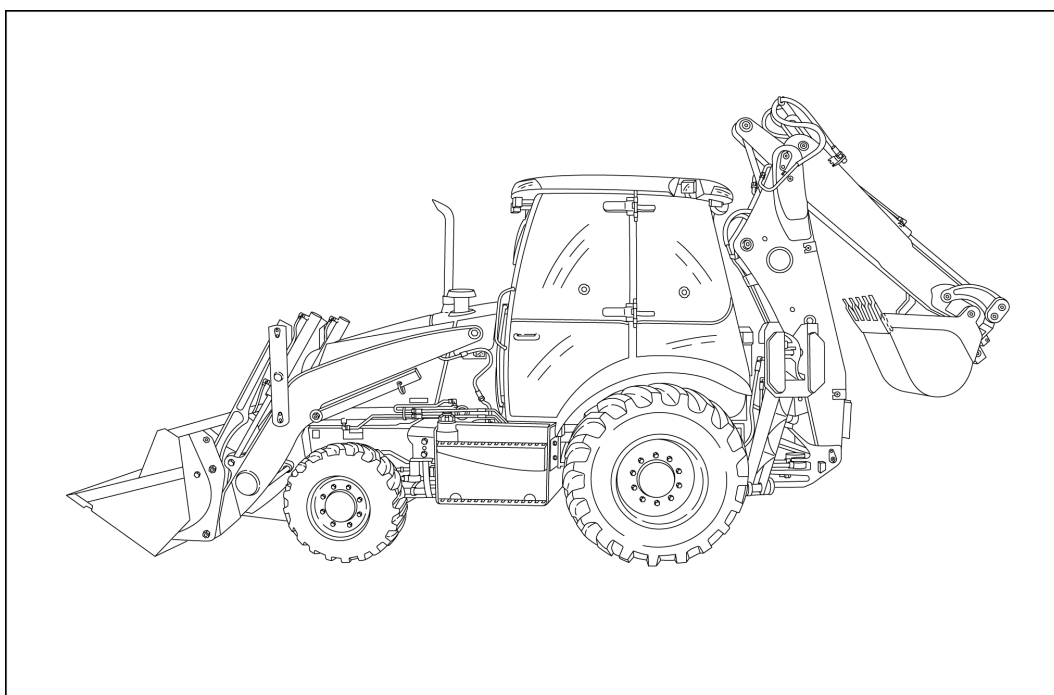

SERVICE MANUAL



580N
580SN WT
580SN
590SN

Contents

INTRODUCTION

Engine.....	10
Engine and crankcase.....	10.001
Fuel tanks	10.216
Engine cooling system	10.400
Exhaust Gas Recirculation (EGR) exhaust treatment.....	10.501
Transmission.....	21
Power Shuttle transmission	21.112
Powershift transmission	21.113
Power Shuttle transmission external controls	21.134
Powershift transmission external controls	21.135
Power Shuttle transmission internal components	21.154
Powershift transmission internal components.....	21.155
Front axle system	25
Powered front axle	25.100
Front bevel gear set and differential.....	25.102
Final drive hub, steering knuckles, and shafts	25.108
Non-powered front axle.....	25.400
Rear axle system.....	27
Powered rear axle	27.100
Rear bevel gear set and differential	27.106
Planetary and final drives.....	27.120
Brakes and controls	33
Parking brake / Parking lock.....	33.110
Hydraulic service brakes	33.202
Hydraulic systems.....	35
Hydraulic systems	35.000

Pump control valves	35.102
Variable displacement pump	35.106
Remote control valves	35.204
Reservoir, cooler, and filters	35.300
Safety and main relief valves	35.350
Main control valve	35.359
Auxiliary hydraulic valves and lines	35.525
Stabilizer hydraulic system	35.703
Front loader bucket hydraulic system	35.723
Excavator and backhoe hydraulic controls	35.726
Boom hydraulic system	35.736
Dipper hydraulic system	35.737
Excavator and backhoe bucket hydraulic system	35.738
Swing arm hydraulic system	35.739
Telescopic arm hydraulic system	35.740
Frames and ballasting	39
Frame	39.100
Stabilizers	39.129
Steering	41
Steering control	41.101
Hydraulic control components	41.200
Cylinders	41.216
Wheels	44
Front wheels	44.511
Rear wheels	44.520
Cab climate control	50
Air conditioning	50.200
Electrical systems	55

Transmission control system	55.024
Harnesses and connectors	55.100
Engine starting system	55.201
Alternator	55.301
Battery	55.302
External lighting	55.404
Warning indicators, alarms, and instruments	55.408
Cab/Platform harnesses and connectors	55.510
Cab engine controls	55.525
FAULT CODES	55.DTC
Front loader and bucket	82
Arm	82.100
Bucket	82.300
Booms, dippers, and buckets	84
Bucket	84.100
Boom pivoting support	84.114
Boom	84.910
Dipper arm	84.912
Platform, cab, bodywork, and decals	90
Machine shields and guards	90.105
Protections - ROPS and FOPS	90.114
Pneumatically-adjusted operator seat	90.124
Cab	90.150
Cab interior	90.151
Cab doors and hatches	90.154



INTRODUCTION

Contents

INTRODUCTION

Safety rules	3
580N NA, 580SN NA, 580SN WT NA, 590SN NA	
Safety rules - Ductile iron	4
580N NA, 580SN NA, 580SN WT NA, 590SN NA	
Safety rules	5
580N NA, 580SN NA, 580SN WT NA, 590SN NA	
Basic instructions - Important notice regarding equipment servicing	6
580N NA, 580SN NA, 580SN WT NA, 590SN NA	
Battery - Basic instructions	7
580N NA T4, 580SN NA T4, 580SN WT NA T4, 590SN NA T4	
Basic instructions - Fuse and relay locations	9
580N NA T4, 580SN NA T4, 580SN WT NA T4, 590SN NA T4	
Basic instructions Fuse, relay and diode icon definitions	13
580N NA T4, 580SN NA T4, 580SN WT NA T4, 590SN NA T4	
Basic instructions - Diagnostic service tool port	20
580N, 580N NA, 580SN, 580SN NA, 580SN WT, 580SN WT NA, 590SN, 590SN NA	
Basic instructions - Welding on the machine	21
580N NA T4, 580SN NA T4, 580SN WT NA T4, 590SN NA T4	
Cab heater - Basic instructions	23
580N NA, 580SN NA, 580SN WT NA, 590SN NA	
Basic instructions	24
580N NA, 580SN NA, 580SN WT NA, 590SN NA	
Torque - Minimum tightening torques for normal assembly	26
580N NA, 580SN NA, 580SN WT NA, 590SN NA	
Torque - Standard torque data for hydraulics	31
580N NA, 580SN NA, 580SN WT NA, 590SN NA	
Abbreviation Measurements	33
580N NA, 580SN NA, 580SN WT NA, 590SN NA	
Capacities	35
580N NA T4, 580SN NA T4, 580SN WT NA T4, 590SN NA T4	
Consumables	37
580N NA T4, 580SN NA T4, 580SN WT NA T4, 590SN NA T4	

Safety rules

580N NA, 580SN NA, 580SN WT NA, 590SN NA

⚠ DANGER

**Improper operation or service of this machine can result in an accident.
Do not operate this machine or perform any lubrication, maintenance, or repair on it until you have read and understood the operation, lubrication, maintenance, and repair information.
Failure to comply will result in death or serious injury.**

D0010A

⚠ WARNING

**Maintenance hazard!
Always perform all service procedures punctually at the intervals stated in this manual. This ensures optimum performance levels and maximum safety during machine operation.
Failure to comply could result in death or serious injury.**

W0132A

⚠ WARNING

**Pressurized system!
Before attempting any service procedure, it is your responsibility to know the number of accumulators on the machine, and the correct procedure for releasing the pressure of each accumulator.
Failure to comply could result in death or serious injury.**

W0136A

NOTICE: *Extreme working and environmental conditions require shortened service intervals.*

Use Case fluids, lubricants, and filters for the best protection and performance of your machine. All fluids, lubricants, and filters must be disposed of in compliance with environmental standards and regulations. Contact your dealer with any questions regarding the service and maintenance of this machine.

Read the safety decals and information decals on the machine. Read the Operator's Manual and safety manual. Understand the operation of the machine before you start any service.

Before you service the machine, put a 'Do Not Operate' tag on the steering wheel or over the key switch. Ensure the tag is at a location where everyone who might operate or service the machine may see clearly. One tag is included with your new machine. Additional tags are available from your dealer.

Plastic and resin parts

- Avoid using gasoline, paint thinner, etc. when cleaning plastic parts, console, instrument cluster, etc.
- Use only water, mild soap, and a soft cloth when you clean these parts.
- Using gasoline, thinners, etc. can cause discoloration, cracking, or deformation of the part being cleaned.

Safety rules - Ductile iron

580N NA, 580SN NA, 580SN WT NA, 590SN NA



⚠ DANGER

**Improper operation or service of this machine can result in an accident.
Any unauthorized modifications made to this machine can have serious consequences. Consult an authorized dealer on changes, additions, or modifications that may be required for this machine. Do not make any unauthorized modifications.
Failure to comply will result in death or serious injury.**

D0030A

Before you weld, cut, or drill holes on any part of this machine, make sure the part is not cast ductile iron. See your dealer if you do not know if a part is cast ductile iron. The following are cast ductile iron parts:

- two wheel drive steering link
- dump links
- front axle
- stabilizers
- extendahoe
- swing
- bucket linkage
- Air Conditioning (A/C) compressor mounting bracket

Unauthorized modifications to cast ductile iron parts can cause injury or death. Welding, cutting, or drilling can cause cast ductile iron to break. Do not weld, cut, or drill to repair or to attach items to cast ductile iron parts on this machine.

Safety rules

580N NA, 580SN NA, 580SN WT NA, 590SN NA

Unless otherwise instructed, always perform these steps before you service the machine:

1. Park the machine on a flat, level surface.
2. Place the backhoe in the transport position with the swing lock pin installed for transport.
3. Place the loader bucket on the ground, with the bottom of the loader bucket parallel to the surface.
4. Place the direction control lever and the transmission in neutral.
5. If you need to open the hood to perform service, raise the loader arms and install the support strut.
6. Shut down the engine.
7. Place a 'Do Not Operate' tag on the key switch so that it is visible to other workers or remove the key.

Basic instructions - Important notice regarding equipment servicing

580N NA, 580SN NA, 580SN WT NA, 590SN NA

All repair and maintenance work listed in this manual must be carried out only by qualified dealership personnel, strictly complying with the instructions given, and using, whenever possible, the special tools.

Anyone who performs repair and maintenance operations without complying with the procedures provided herein shall be responsible for any subsequent damages.

The manufacturer and all the organizations of its distribution chain, including - without limitation - national, regional, or local dealers, reject any responsibility for damages caused by parts and/or components not approved by the manufacturer, including those used for the servicing or repair of the product manufactured or marketed by the manufacturer. In any case, no warranty is given or attributed on the product manufactured or marketed by the manufacturer in case of damages caused by parts and/or components not approved by the manufacturer.

The information in this manual is up-to-date at the date of the publication. It is the policy of the manufacturer for continuous improvement. Some information could not be updated due to modifications of a technical or commercial type, or changes to the laws and regulations of different countries.

In case of questions, refer to your CASE CONSTRUCTION Sales and Service Networks.

Battery - Basic instructions

580N NA T4, 580SN NA T4, 580SN WT NA T4, 590SN NA T4

⚠ WARNING

Explosive gas!

Batteries emit explosive hydrogen gas and other fumes while charging. Ventilate the charging area. Keep the battery away from sparks, open flames, and other ignition sources. Never charge a frozen battery.

Failure to comply could result in death or serious injury.

W0005A

⚠ WARNING

Hazardous chemicals!

Battery electrolyte contains sulfuric acid. Contact with skin and eyes could result in severe irritation and burns. Always wear splash-proof goggles and protective clothing (gloves and aprons). Wash hands after handling.

Failure to comply could result in death or serious injury.

W0006A

- Do not run the engine with the alternator wires disconnected.
- Before using an electric welder, disconnect the alternator wires, instrument cluster and batteries. Disconnect the ECU connectors.
- Do not use a steam cleaner or a cleaning solvent to clean the alternator.
- Keep the battery vents clean. Ensure the battery vents are not restricted.

Disconnect battery

1. Remove the battery cover hardware.

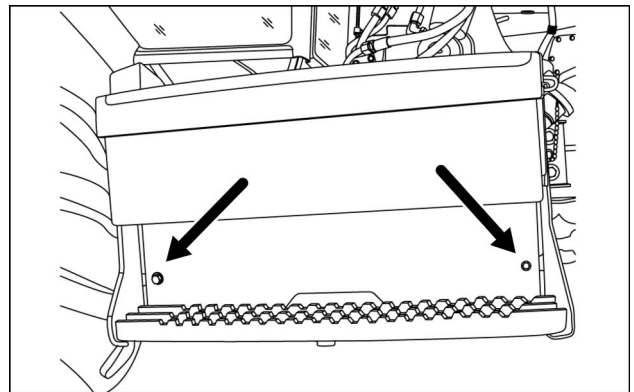

RCPH11TLB001AAM 1

2. Remove the battery cover.

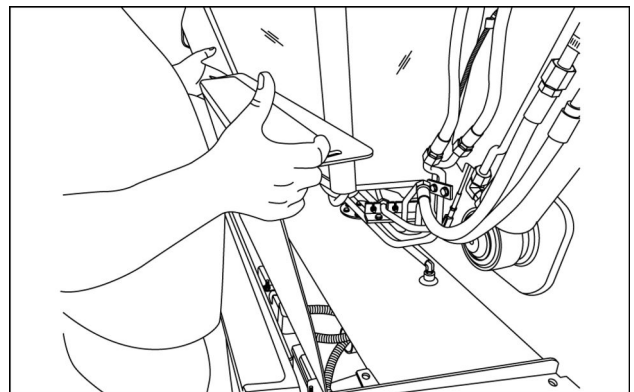

RCPH11TLB002AAM 2

3. Disconnect the negative battery cable from the negative battery terminal.

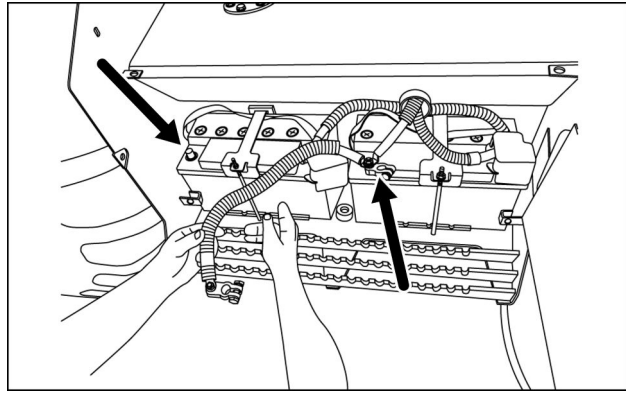

RCPH11TLB003AAM 3

Master disconnect switch (if equipped)

Enable or disable electrical power from the machine batteries to the electrical components using the master disconnect switch, located on the right hand side of the engine.

NOTICE: Wait at least 60 seconds after ignition key is placed in the OFF position before turning master disconnect switch to OFF. This allows the machine controllers to shutdown properly.

NOTICE: Some machine service procedures require an actual terminal disconnect of the batteries. Do not use the master disconnect for those types of procedures, such as welding on the machine.

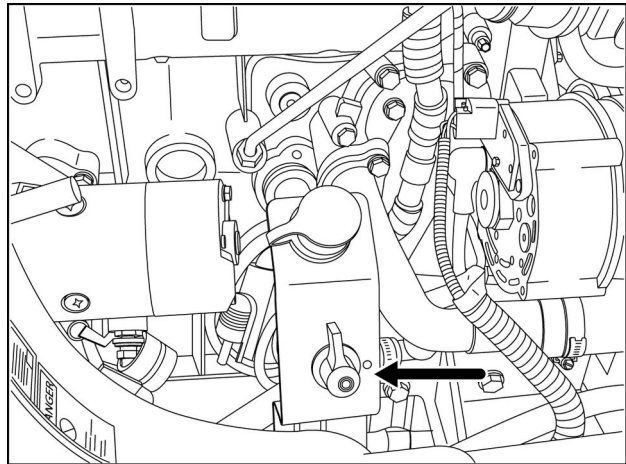

RCPH11TLB002BAD 4

Basic instructions - Fuse and relay locations

580N NA T4, 580SN NA T4, 580SN WT NA T4, 590SN NA T4

The machine is equipped with four fuse box locations. Two locations in the front console, a side console box and an external location.

Front console box

1. Turn the thumb screw (1) to loosen the panel cover (2) for the fuse box. Remove the panel cover.

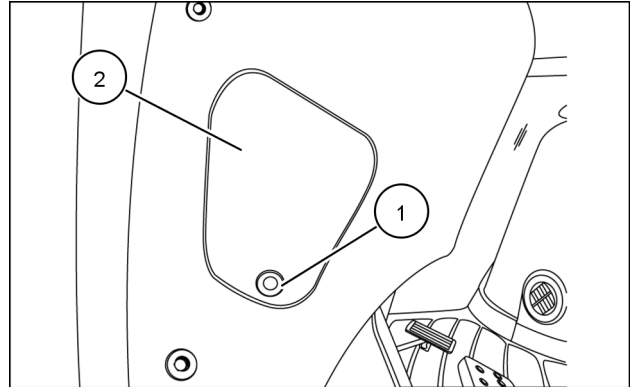

RCPH10TLB320AAF 1

2. Remove the fuse box cover.

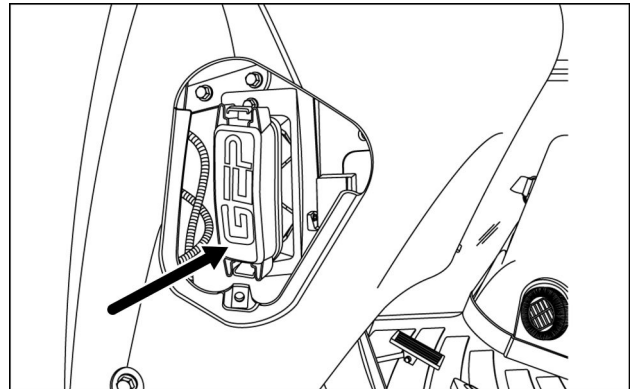

RCPH10TLB307AAF 2

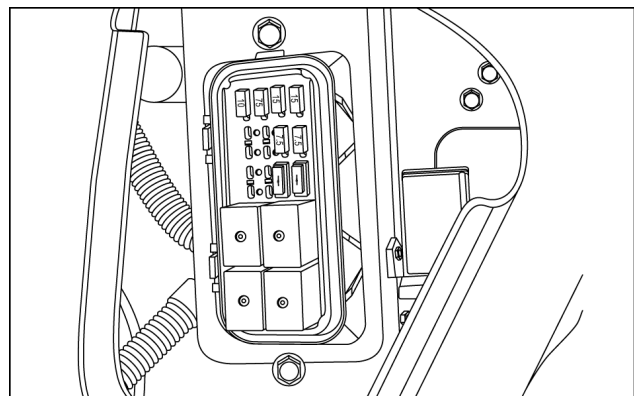

RCPH10TLB303AAF 3

3. Refer to the decal on the interior side of the panel cover for fuse, relay, and/or diode functions.

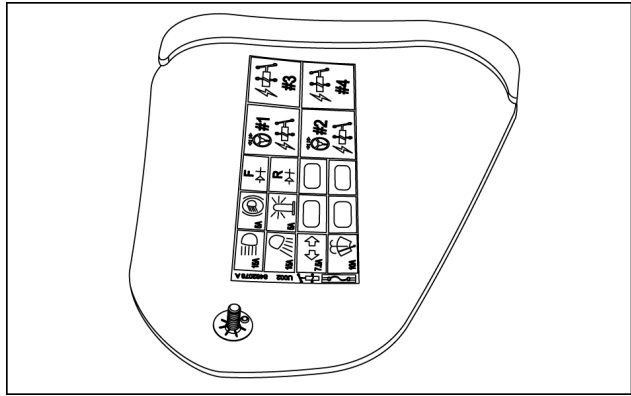

RCPH10TLB310AAF 4

Front console ECU fuse and relay

1. Remove the cover from the steering column shroud.

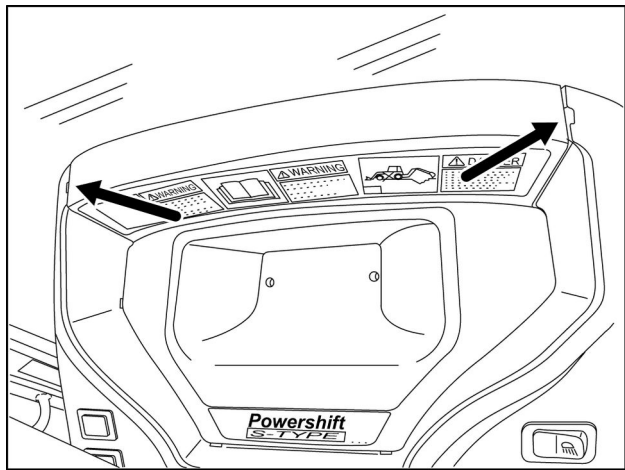

RCPH11TLB012BAD 5

Fuse or relay reference	Designation
(1)	ECU B+ relay
(2)	ECU B+ 20 A fuse
(3)	ECU B+ 7.5 A fuse
(4)	LAMBDA SENSOR B+ 7.5 A fuse

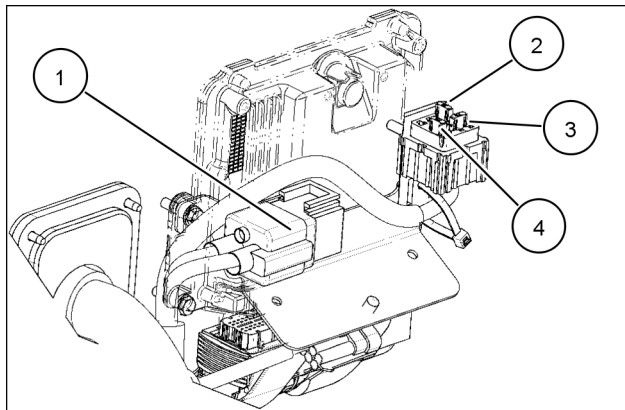

RAPH12TLB0016BA 6

Side console box

1. Turn the thumb screws (1) to loosen the panel cover (2) for the fuse box. Remove the panel cover.

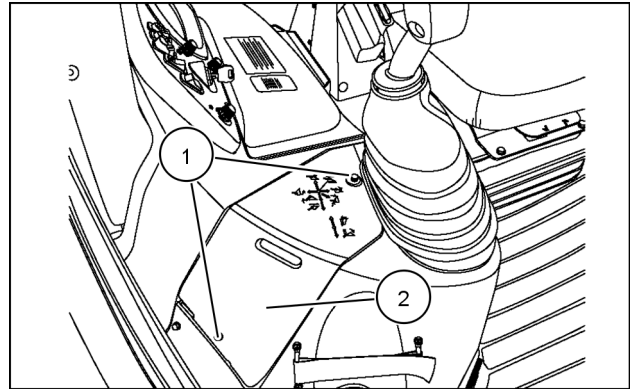

RCPH10TLB437AAF 7

2. Remove the fuse box covers as needed.

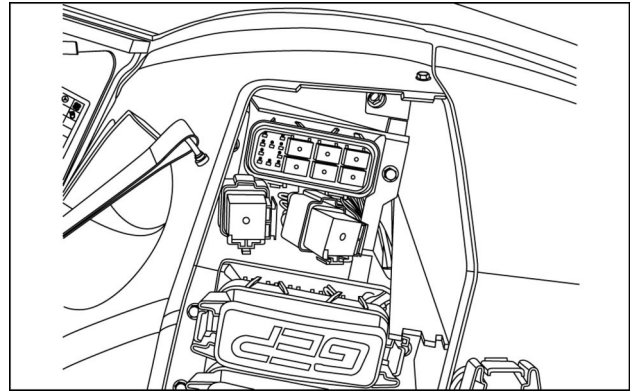

RCPH10TLB301AAF 8

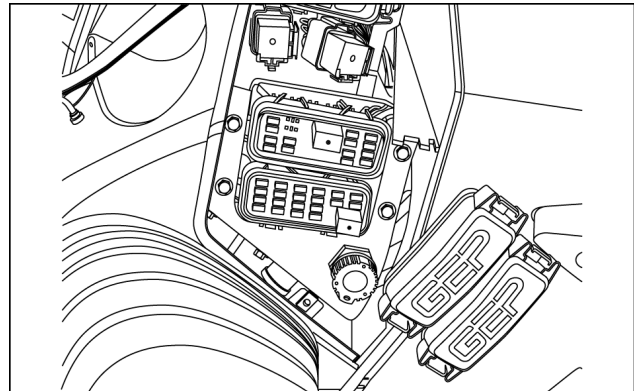

RCPH10TLB302AAF 9

3. Refer to the decal on the interior side of the panel cover for fuse, relay, and/or diode functions.

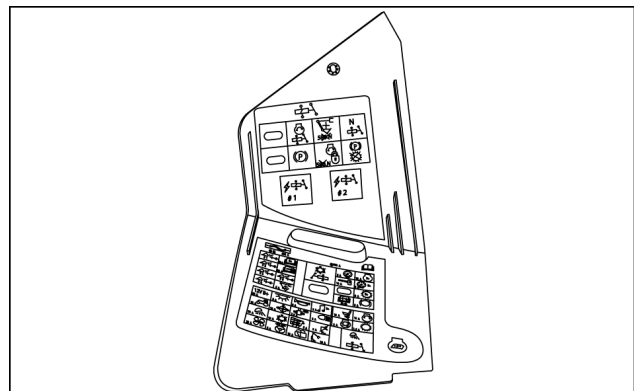

RCPH10TLB319AAF 10

Glow-plug Control Unit (GCU) fuse

1. Raise the loader arm and engage the safety support.
2. Lift the engine hood.
3. Locate the **60 A** fuse box for the GCU on the right hand side of the engine attached to the cab frame.

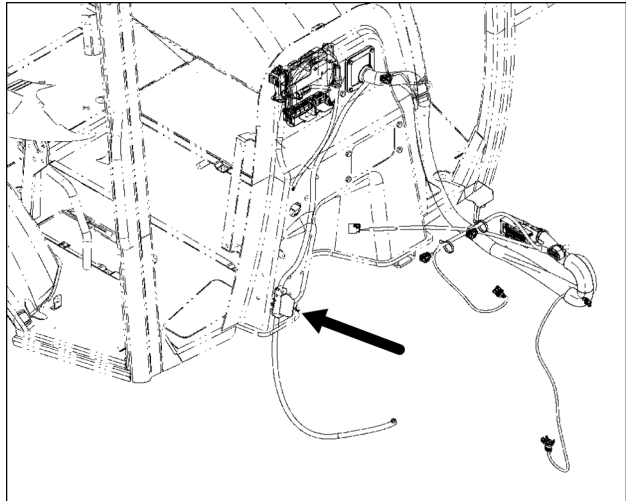

RAPH12TLB0017BA 11

Basic instructions Fuse, relay and diode icon definitions

580N NA T4, 580SN NA T4, 580SN WT NA T4, 590SN NA T4



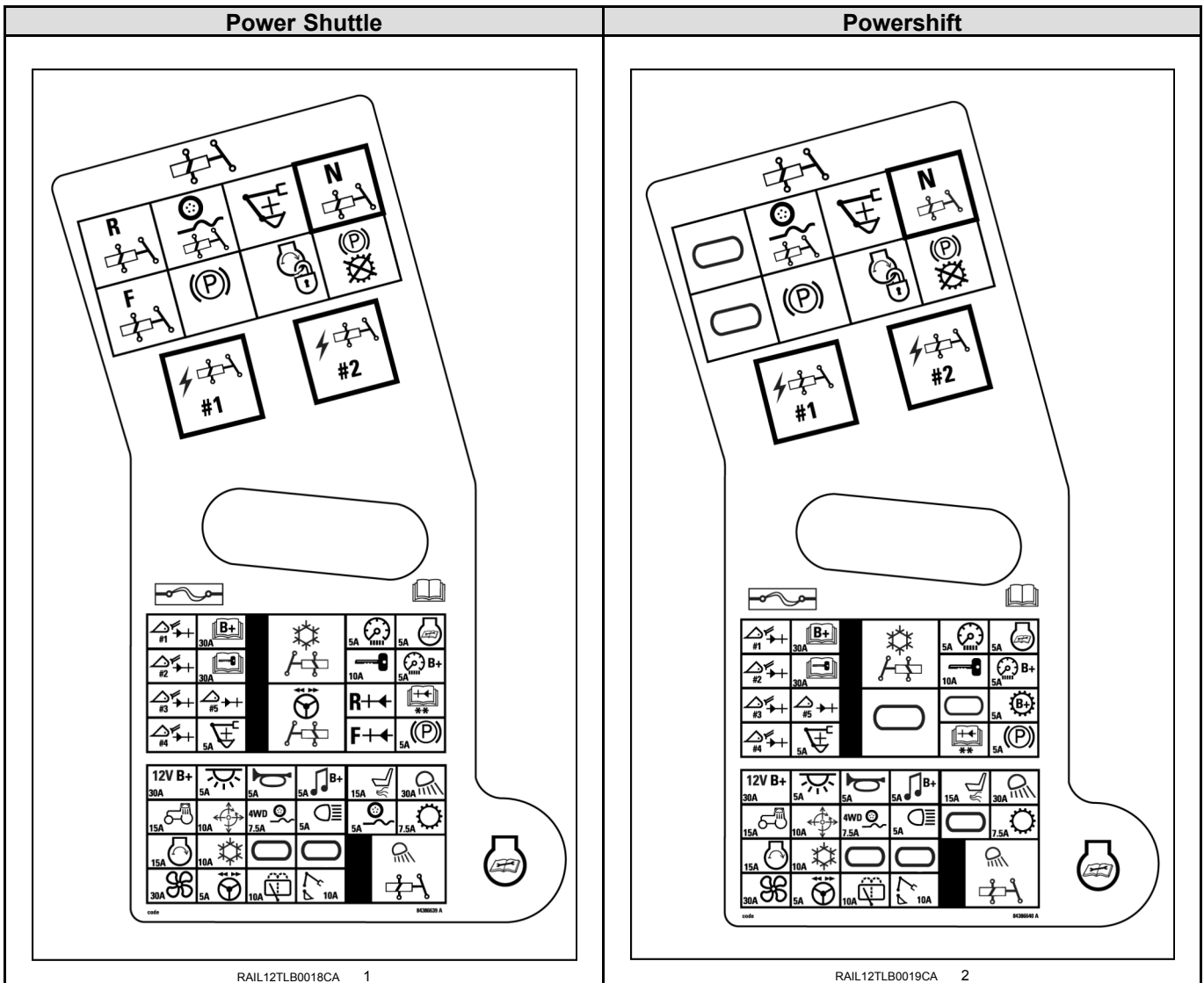











Right hand side console panel







Fuse icon definitions

Symbol	Function
	ECU B+
	Instrument cluster key ON
	Instrument cluster B+



INTRODUCTION



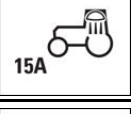
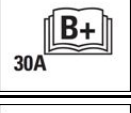
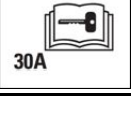

Symbol	Function
	Rear lights
	Rear wipers/washers
	Transmission differential lock
	Tail lights
	Pilot controls
	Cigarette lighter plugs
	4WD, Auto Ride Control
	Dome light
	Radio B+
	Horn
	Blower motor
	A/C
	TRAX B+
	Key switch
	Air seat

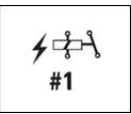
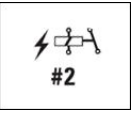
INTRODUCTION

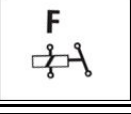
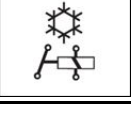

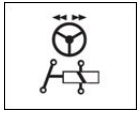
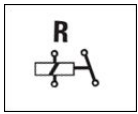
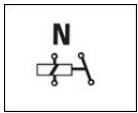
Symbol	Function
 5A	2WD, Ride Control
 10A	Quick coupler, EH Clam, Radio Key ON
 5A	SAHR brake
 5A	Comfort Steer
 5A	PowerLift
 15A	Side lights
 30A	Customer B+
 30A	Customer key ON

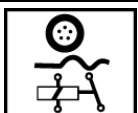
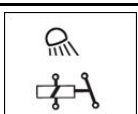
Relay icon definitions

Symbol	Function
 #1	Power relay #1
 #2	Power relay #2
 (P)	SAHR park brake relay
 (P)	SAHR park brake transmission cutout relay
 F	Forward relay (Power Shuttle only)
	A/C relay

Symbol	Function
	Comfort Steer relay (Power Shuttle only)
	Reverse relay (Power Shuttle only)
	Neutral relay
	Starter interlock relay
	Auto Ride Control relay
	Rear light relay
	PowerLift relay

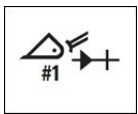
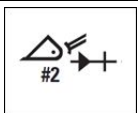
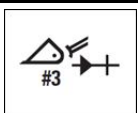
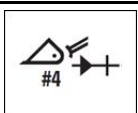
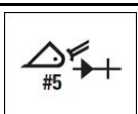
Diode icon definitions

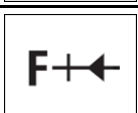
Symbol	Function
	Quick coupler diode #1
	Quick coupler diode #2
	Quick coupler diode #3
	Quick coupler diode #4
	Quick coupler diode #5
	Reverse signal diode (Power Shuttle only)
	Forward signal diode (Power Shuttle only)