



Electrical troubleshooting manual

Series 3 – E36 (316i, 318i, 318is, 320i, 323i, 328i, M3, 318tds, 325td, 325tds incl. Convertible and Touring)

Schematics

Model year 1998

0100.0	Index	2460.5	Electronic transmission control (EGS A5S 310Z Diesel)
0110.0	Introduction	2460.11	Electronic transmission control (EGS A5S 300J M52)
0140.0	Symbols	2460.12	Sequential M–transmission (SMG)
0670.0	Power distribution chart	3234.0	Airbag (AB)
0670.1	Fuse chart	3450.0	Antilock brake system (ABS)
0670.2	Power distribution	3450.1	Automatic stability control (ASC)
0670.3	Fuse details	5116.0	Power mirrors
0670.4	Ground distribution	5120.0	Door lock heating (ZKE/TSH)
0670.5	Diagnostic link	5120.1	Door lock heating (ZVM/TSH)
1210.17	Engine management MS41.0 (6–cylinder M52)	5126.0	Central locking system (ZKE/ZV)
1210.19	Digital motor electronics (DME M1.7.3, 4–cylinder M43)	5126.2	Central locking module II (ZVM II)
1210.20	Digital motor electronics (DME M5.2, 4–cylinder M44)	5133.0	Power windows (ZKE/FH)
1210.21	Digital motor electronics (DME MSS50, 6–cylinder S50 B32)	5200.2	Electric seat adjustment and lumbar support
1220.0	Preheating system	5203.0	Heated seats
1230.0	Alternator	5410.1	Power tilt/slide sunroof (SHD)
1240.0	Starter	5430.1	Electrical convertible soft top
1360.2	Digital diesel electronics (DDE 2.1, 6–cylinder M51)	6100.0	Central body electronics (ZKE IV)
1360.3	Digital diesel electronics (DDE 2.1, 4–cylinder M41)	6133.0	Horn
2460.2	Electronic transmission control (EGS A4S 310R)	6135.0	Electronic immobiliser (EWS II)
2460.3	Electronic transmission control (EGS A4S 270R Diesel)	6160.1	Wipe/wash module (WWM)
2460.4	Electronic transmission control (EGS A5S 310Z)	6167.1	Headlight washer system (SRA)
		6169.0	Windscreen washer jet heaters
		6211.0	Instrument cluster
		6213.1	Analogue clock
		6213.2	Multi–function clock
		6214.0	On–board display

Schematics

6300.0	Light switch	6450.7	Automatic climate control (IHKA E36)
6312.0	Headlight/fog light	6510.0	Radio/Stereo
6313.0	Turn signal/hazard warning system	6510.1	Radio/HiFi/Top Hifi
6314.0	Park/tail/underhood lights	6561.0	Cellular telephone
6320.0	Licence plate/luggage compartment lights	6571.0	Cruise control
6322.0	Reversing lights	6581.2	On-board computer (BC V)
6325.0	Brake lights	6610.2	Remote control ZV/DWA
6328.1	Trailer coupling	6621.0	Park distance control (PDC)
6330.3	Interior lights	7000.0	Component location chart
6332.0	Interior	7100.0	Component location views
6350.0	Crash and alarm sensor	8000.0	Connector location views (soldering spots and comb-type connectors)
6410.5	Automatic heating control (HR)	8500.0	Connector views
6412.10	Independent ventilation with HR		
6412.20	Independent ventilation with IHKA E36		
6424.0	Rear window defogger/antenna		



A/C compressor relay, K19	6450.7-04
A/C fan II switch, S2138	6450.7-07
ABS control unit, A7	3450.0-00
ABS hydraulic unit, Y1	3450.0-01
ABS hydraulic unit, Y1	3450.1-01
ABS overvoltage protection relay, K10	3450.0-00
ABS overvoltage protection relay, K10	3450.1-00
ABS pump motor relay, K75	3450.0-00
ABS pump motor relay, K75	3450.1-01
ABS pump motor relay, timed, K125	3450.1-06
ABS travel sensor, S123	3450.1-01
ABS/ASC control unit, A52	3450.1-00
Acceleration sensor, lateral, A139	2460.12-09
Acceleration sensor, longitudinal, B49	2460.12-09
ADS actuator, M93	3450.1-02
Air flow meter, B6233	1210.19-06
Air pump, Y6133	1210.21-04
Airbag (AB)	3234.0
Airbag diagnostic module, A12	3234.0-00
Alternator	1230.0
Alternator cut-out relay, K2200	1230.0-00
Alternator, G2023	1230.0
Alternator, G6509	1230.0
AM/FM antenna amplifier, N8	6424.0-00
Analogue clock	6213.1
Analogue clock, N5	6213.1-00
Antilock brake system (ABS)	3450.0
Antitheft (DWA) LED, V5	6100.0-03
Antitheft (DWA) radio microswitch, S20	6100.0-02
Antitheft horn (DWA), H1	6100.0-03
ASC diode, V7	3450.1-00
ASC switch, S6	3450.1-02
ASC throttle potentiometer, R6253	3450.1-04
AUC sensor, B414	6450.7-01
Automatic climate control (IHKA E36)	6450.7

Automatic climate control unit, A115	6450.7-00
Automatic heating control (HR)	6410.5
Automatic stability control (ASC)	3450.1
Auxiliary fan motor, M9	6450.7
Auxiliary fan stage 1 relay, K21	6450.7
Auxiliary fan stage 2 relay, K22	6450.7
Auxiliary fuse box, P95	0670.2-06
Auxiliary fuse box, P97	0670.2
Auxiliary relay box, P92	0670.2
B+ external start terminal point, G6430	0670.2
Battery, G1	0670.2
Blower ballast resistor, R11	6410.5-01
Blower ballast resistor, R11	6412.10-01
Blower motor, M30	6410.5-01
Blower motor, M30	6412.10-01
Blower motor, M30	6450.7-00
Blower switch, S75	6410.5-01
Blower switch, S75	6412.10-00
Brake fluid level switch, B18	6211.0-00
Brake light switch, S29	6325.0-02
Brake light switch, S30	6325.0-00
Brake lights	6325.0
Camshaft sensor, B6204	1210
Capacitor, C1	6330.3-01
Cassette box light, E45y	6332.0-00
CD changer, N22	6510.1-00
Cellular telephone	6561.0
Central body electronics (ZKE IV)	6100.0
Central locking (ZV) drive driver's door, M12	5126
Central locking (ZV) drive passenger's door, M13	5126
Central locking drive (ZV) glovebox, M107	5126.0-03
Central locking drive rear left, M15	5126
Central locking drive rear lid, M17	5126
Central locking drive rear right, M14	5126
Central locking module (ZVM), A30	5126.2



Central locking module II (ZVM II)	5126.2
Central locking switch, S302y	6100.0-01
Central locking system (ZKE/ZV)	5126.0
Central power window switch, S40y	5133.0-04
Changeover valve for exhaust gas recirculation (AGR), B2017	1360.3-02
Changeover valve I, Y6131	1210.19-01
Changeover valve I, Y6131	1210.20-01
Charcoal filter valve, Y6120	1210
Charge air temperature sensor, B2012	1360
Charge pressure sensor, B2014	1360
Charge socket, X779	6322.0-00
Check control module, A4	6581.2-04
Child safety lock (centre console), S130	5133.0-02
Circulation air flap motor, M40	6450.7-03
Clutch switch, S32	6571.0-01
Comfort relay, K114	5133.0-06
Comfort relay, K114	5410.1-00
Component location chart	7000.0
Component location views	7100.0
Conductor loop hinged window left, R28	6100.0-07
Conductor loop hinged window right, R27	6100.0-07
Connector location views (soldering spots and comb-type connectors)	8000.0
Connector views	8500.0
Contact rear left door, S125	6100.0-04
Control unit, remote control, A194y	6610.2
Convertible soft top deadpoint microswitch, S164	5430.1-01
Convertible soft top drive, M101	5430.1-02
Convertible soft top flap drive, M100	5430.1-02
Convertible soft top flap lock, M43	5430.1-02
Convertible soft top flap microswitch, S214	5430.1-04
Convertible soft top microswitch, S165	5430.1-01
Convertible soft top module, A96	5430.1
Coolant level switch, S63	6581.2-03
Coolant temperature sensor, B2015	1360

Crankshaft sensor, B6203	1210
Crash actuator, left, Y85	5430.1-03
Crash actuator, right, Y86	5430.1-03
Crash alarm sensor, N17	6350.0-01
Crash and alarm sensor	6350.0
Cruise control	6571.0
Cruise control actuator (Tempomat), M25	6571.0-01
Cruise control module, A8	6571.0-00
Cruise control switch, S28	6571.0-00
DDE relay, K2003	1360
DDE2 control unit, A2019	1360
Decoupling diode lighting, V9	6312.0-01
Decoupling diode, V9501	1230.0-01
Defroster flap motor, M35	6450.7-03
Delivery pump relay, K2081	1360.3-00
Diagnostic connector, D100	0670.5-00
Diagnostic link	0670.5
Digital diesel electronics (DDE 2.1, 4-cylinder M41)	1360.3
Digital diesel electronics (DDE 2.1, 6-cylinder M51)	1360.2
Digital motor electronics (DME M1.7.3, 4-cylinder M43)	1210.19
Digital motor electronics (DME M5.2, 4-cylinder M44)	1210.20
Digital motor electronics (DME MSS50, 6-cylinder S50 B32)	1210.21
Dimmer, N3	6300.0-00
DME control unit, A6000	1210
DME relay, K6300	1210
Door lock heating (ZKE/TSH)	5120.0
Door lock heating (ZVM/TSH)	5120.1
Door lock heating relay, K54	5120.1-00
Door lock heating, E48	5120
Driver's airbag gas generator, G5	3234.0-00
Driver's backrest heating, E56	5203.0-00
Driver's backrest recliner motor, M53	5200.2-00
Driver's door contact switch, S14	5126.2-04
Driver's door contact switch, S14	6100.0-04
Driver's door handle switch, S48	5126.0



Driver's door lock switch, S47	5126
Driver's door power window switch, S126y	5133.0-00
Driver's lumbar support switch, S52	5200.2-02
Driver's lumbar support/compressor valve, M55z	5200.2-02
Driver's make-up mirror light, E35	6330.3-00
Driver's make-up mirror switch, S77	6330.3-00
Driver's power mirror switch, S17	5116.0-00
Driver's seat adjustment switch, S51	5200.2-00
Driver's seat belt buckle switch, S58	6211.0-01
Driver's seat cushion tilt motor, M50	5200.2-00
Driver's seat heating switch, S53	5203.0-00
Driver's seat heating, E57	5203.0-00
Driver's seat height adjustment motor, M52	5200.2-00
Driver's seat movement motor, M51	5200.2-00
Driver's side impact sensor, B78	3234.0-01
Driver's window monitoring switch (DWA), S100	6100.0-06
Driver's window motor, M21	5133.0-01
Dual temperature sensor (coolant temperature), B6256	1210.17-02
Dual temperature sensor (coolant temperature), B6256	1210.21-05
Dual temperature sensor, B2232	1220.0-00
Dual temperature sensor, B2232	1360.3-05
Dual temperature sensor, B2232	6211.0-05
Dual temperature switch 80 °C/88 °C, S36y	6450.7
Dual temperature switch 91 °C/99 °C, S36	6450.7
EGS control unit, A2120	2460.3
EGS control unit, A2154	2460.5
EGS control unit, A7000	2460.11
EGS control unit, A7000	2460.4
EGS control unit, A8500	2460.2
EJECT box telephone, A117	6561.0-00
EKP and start detector relay, K6307	1210.21-02
Electric cutout, Y2009	1360
Electric seat adjustment and lumbar support	5200.2
Electrical convertible soft top	5430.1
Electrical fuel pump relay, K6301	1210

Electrochromatic rear view mirror, A22z	5116.0-02
Electronic gear indicator, A133	2460.12
Electronic immobiliser (EWS II)	6135.0
Electronic immobiliser control unit (EWS II), A836	6135.0
Electronic seat control, A113	3234.0-00
Electronic transmission control (EGS A4S 270R Diesel)	2460.3
Electronic transmission control (EGS A4S 310R)	2460.2
Electronic transmission control (EGS A5S 300J M52)	2460.11
Electronic transmission control (EGS A5S 310Z Diesel)	2460.5
Electronic transmission control (EGS A5S 310Z)	2460.4
Engine management MS41.0 (6-cylinder M52)	1210.17
Engine speed sensor, B2013	1360
Evaporator sensor, B14	6450.7-02
Exhaust return actuator, B2244	1360
Exhaust-gas flap valve, Y198	1210.17-04
Feed pump relay, K2002	1360
Fog light relay, K47	6312.0
Fog light switch, S10	6312.0-00
Fog light switch, S82	6312.0-02
Foot and rear flap regulating motor, M46	6450.7-03
Fresh air flap motor, M36	6450.7-00
Front ashtray light, E25	6332.0-00
Front cigar lighter light, E29	6332.0-00
Front cigar lighter, E28	6332.0-00
Front left ABS sensor, B2	3450.0-02
Front left ABS sensor, B2	3450.1
Front left auxiliary flasher unit, H9	6313.0-02
Front left brake pad sensor, B16	6211.0-01
Front left flasher unit, H7	6313.0-02
Front left footwell light, E61	6330.3-02
Front lid microswitch, S21	6100.0-02
Front lid switch, left, S138y	2460.12-10
Front lid switch, right, S137y	2460.12-10
Front power distribution box, P90	0670.2
Front right ABS sensor, B1	3450.0-02



Front right ABS sensor, B1	3450.1
Front right auxiliary flasher unit, H8	6313.0-02
Front right flasher unit, H4	6313.0-02
Front right footwell light, E62	6330.3-02
Fuel heating, E2000	1360
Fuel injector 1, Y6101	1210
Fuel injector 2, Y6102	1210
Fuel injector 3, Y6103	1210
Fuel injector 4, Y6104	1210
Fuel injector 5, Y6105	1210
Fuel injector 6, Y6106	1210
Fuel pump (EKP I), M2	1210
Fuel pump (EKP I), M2	1360
Fuse chart	0670.1
Fuse details	0670.3
Fuse link, F97	0670.2
Gas generator, left side airbag, G14	3234.0-01
Gas generator, right side airbag, G15	3234.0-01
Gear indicator light, E82	6300.0-02
Gear indicator, centre console, A135	2460.12
Gear indicator, instrument cluster, A141	2460.12-07
Gear recognition potentiometer, R5140	2460.12-04
Gear selector lever switch, S3	2460
Gear shift unit, Y2153	2460.5-01
Gear-shift unit, Y8505	2460
Gearshift unit, Y8505y	2460.2-02
Gearshift unit, Y8505y	2460.4-01
Glovebox light/switch, E42y	6332.0-00
Glow plug cyl. 1, X2091	1220.0
Glow plug cyl. 2, X2092	1220.0
Glow plug cyl. 3, X2093	1220.0
Glow plug cyl. 4, X2094	1220.0
Glow plug cyl. 5, X2095	1220.0
Glow plug cyl. 6, X2096	1220.0
Gong I, H10	6213.2-01

Gong I, H10	6581.2-02
Gradient monitor (DWA), B28	6100.0-03
Ground distribution	0670.4
Hall sensor, camshaft, B6209	1210.20-03
Handbrake switch, S31	6211.0-00
Hardtop mount, left, E99	5430.1-00
Hardtop mount, right, E100y	6330.3-05
Hardtop mount, right, E100y	6424.0-02
Hazard flasher relay, K16	6313.0-00
Hazard warning switch, S18	6313.0-01
Headlight beam angle adjust potentiometer, R13	6312.0-04
Headlight relay, K48	6312.0-03
Headlight washer pump, M7	6167.1-00
Headlight washer system (SRA)	6167.1
Headlight/fog light	6312.0
Heated oxygen sensor, B6200	1210
Heated seats	5203.0
Heater plug relay, K2000	1220.0-01
Heating blower relay, K4	6410.5-00
Heating blower relay, K4	6412.10-00
Heating blower relay, K4	6450.7-00
Hifi amplifier, A18	6510.1-00
High beam relay, K46	6312.0-03
High-mounted brake lamp/rear spoiler, H34z	6325.0-02
Hinged window relay, K113	5133.0-06
Hinged window switch LH, S182	5133.0-06
Hinged window switch RH, S183	5133.0-06
Horn	6133.0
Horn relay, K2	6133.0-00
Horn switch, S4	6133.0-00
Hot film air mass meter, B6217	1210
Hot film air mass meter, B6217	1360.2-08
Hot-film air mass meter, B6207	1210.17-05
Hydraulic pump relay, K5360	2460.12-00
Hydraulic unit, Y1z	2460.12



Idle actuator, Y6130	1210
Ignition coil 1, T6151	1210
Ignition coil 2, T6152	1210
Ignition coil 3, T6153	1210
Ignition coil 4, T6154	1210
Ignition coil 5, T6155	1210
Ignition coil 6, T6156	1210
Ignition switch, S2	0670.2-07
Immersion tube sensor II, B25y	6211.0-08
Immersion tube sensor, B6	6211.0-07
Independent ventilation relay, K450	6412.10-01
Independent ventilation relay, K450	6412.20-00
Independent ventilation with HR	6412.10
Independent ventilation with IHKA E36	6412.20
Index	0100.0
Injection quantity control unit, Y2010	1360
Instrument cluster	6211.0
Instrument cluster, A2w	6211.0
Intake air temperature sensor, B6205	1210
Interior	6332.0
Interior light, left rear, E39	6330.3-00
Interior light, right rear, E40	6330.3-00
Interior lights	6330.3
Interior/reading lamp, front, E34	6330.3-00
Introduction	0110.0
Kick-down switch, S8507	2460
Knock sensor 1 (cyl. 1 and 2), B6241	1210.21-05
Knock sensor 1, B6241z	1210.19-06
Knock sensor 2 (cyl. 3 and 4), B6242	1210.21-05
Knock sensor 3 (cyl. 5 and 6), B6243	1210.21-05
Knock sensor, B6240	1210.17-06
Knock sensor, B6240	1210.20-04
Knock sensor, B6240	1210.20-05
Left brake light, H24	6325.0-01
Left catalytic converter thermal sensor, B23	6211.0-09

Left fog light, E26	6312.0-00
Left front high range speaker, H59	6510.0-00
Left front high range speaker, H59	6510.1-03
Left front low range speaker, H58	6510.0-00
Left front low range speaker, H58	6510.1-03
Left front mid-range speaker, H55	6510.1-03
Left headlight beam angle adjust actuator, M80	6312.0-04
Left headlight, E13	6312.0-03
Left headlight, E7	6312.0-03
Left headlight, E7	6314.0-01
Left heat exchanger sensor, B11	6450.7-02
Left high beam, E11	6312.0-03
Left horn, H2	6133.0-00
Left licence plate light, E43	6320.0-00
Left mid-range/high range speaker, H42	6510.1-04
Left outside mirror, Y5	5116.0-01
Left parking light relay, K26	6314.0-02
Left parking light, E15	6314.0-01
Left rear fog light, H26	6312.0-02
Left rear high range speaker, H56	6510.1-03
Left rear lid light, E46	6312.0-02
Left rear lid light, E46	6313.0-03
Left rear lid light, E46	6314.0-01
Left rear lid light, E46	6314.0-04
Left rear lid light, E46	6322.0-00
Left rear lid light, E46	6325.0-01
Left rear lid light, E46	6325.0-02
Left rear low range speaker, H57	6510.1-03
Left reversing light, H27	6322.0-00
Left speaker, H41	6561.0-00
Left tail light, H37	6314.0-01
Left vent window motor, M103	5133.0-06
Left windscreen washer jet heater, E51	6169.0-00
Licence plate/luggage compartment lights	6320.0
Light switch	6300.0



Light switch, S8	6300.0-00
Lockout relay, C900	6424.0-01
Luggage compartment light switch, S61y	6320.0-01
Luggage compartment light, E32	6320.0-00
Luggage compartment light, E32	6330.3-00
Luggage compartment light, left, E101	6320.0-02
Luggage compartment light, right, E102	6320.0-02
Motor, windscreen cowl panel lock, M132	5430.1-00
Multi-function clock	6213.2
Multi-function clock, N10	6213.2-00
Needle motion sensor, Y2008	1360
Oil level switch, thermal, B6254	1210.21-07
Oil level, B6230	6211.0
Oil pressure switch, B2008	6211.0
Oil pressure switch, B6231	6211.0
Oil temperature sensor, B6238	6211.0-02
On-board computer (BC V)	6581.2
On-board computer temperature sensor, B21	6581.2-00
On-board computer, N4	6581.2-00
On-board display	6214.0
On-board display, A35	6214.0-00
Output stage, N2	6450.7-00
Outside temperature sensor, B13	6450.7-02
Oxygen sensor and air pump relays, K6309	1210.21-00
Oxygen sensor I in front of catalytic converter, B62101	1210.21-04
Oxygen sensor II in front of catalytic converter, B62201	1210.21-04
Oxygen sensor in front of catalytic converter, B62001	1210.20-03
Oxygen sensor relay, K6303	1210
Park distance control (PDC)	6621.0
Park/tail/underhood lights	6314.0
Parking aid control unit, A81	6621.0-00
Parking aid speaker, H40	6621.0-00
Passenger's airbag gas generator, G6	3234.0-00
Passenger's backrest heating, E59	5203.0-00
Passenger's backrest recliner motor, M58	5200.2-01

Passenger's door contact switch, S13	5126.2-04
Passenger's door contact switch, S13	6100.0-04
Passenger's door lock switch, S49	5126
Passenger's door power window switch, S127y	5133.0-00
Passenger's make-up mirror light, E36	6330.3-00
Passenger's make-up mirror switch, S78	6330.3-00
Passenger's seat adjustment switch, S56	5200.2-01
Passenger's seat cushion tilt motor, M61	5200.2-01
Passenger's seat heating switch, S54	5203.0-00
Passenger's seat heating, E58	5203.0-00
Passenger's seat height adjustment motor, M59	5200.2-01
Passenger's seat movement motor, M60	5200.2-01
Passenger's side impact sensor, B79	3234.0-01
Passenger's window monitoring switch (DWA), S99	6100.0-06
Passenger's window motor, M23	5133.0-01
Pedal value sensor, R10	1360
Plug socket, left reading light, X18262x	6332.0-01
Plug socket, right reading light, X18262y	6332.0-01
Power distribution	0670.2
Power distribution chart	0670.0
Power mirrors	5116.0
Power tilt/slide sunroof (SHD)	5410.1
Power window motor, rear left, M20	5133.0-02
Power window motor, rear right, M22	5133.0-02
Power windows (ZKE/FH)	5133.0
Preheating system	1220.0
Pressure switch, B8y	6450.7
Pressure switch, B8y	6450.7
Pressure switch, B9508	6450.7
Pressure switch, B9508	6450.7
Pressure switch, B9y	6450.7
Pressure switch, B9y	6450.7
Program switch, A136	2460.12-08
Program switch, S8503	2460
Radio, N9	6510.0-00



Radio, N9	6510.1-00
Radio/HiFi/Top Hifi	6510.1
Radio/Stereo	6510.0
Raised brake light, H34	6325.0
Reading lights relay, K127y	6332.0-01
Rear ashtray light, E28y	6332.0-00
Rear centre left converter, B35	6621.0-01
Rear centre right converter, B36	6621.0-01
Rear defogger relay, K13	6424.0
Rear defogger/antenna, E10	6424.0-01
Rear left ABS sensor, B4	3450.0-02
Rear left ABS sensor, B4	3450.1
Rear left converter, B34	6621.0-01
Rear left door DWA conductor loop, R21	6100.0-06
Rear left flasher unit, H6	6313.0-03
Rear left power window motor, M98	5133.0-05
Rear left power window switch, S128z	5133.0-04
Rear left speaker, H46	6510.0-00
Rear left speaker, H46	6510.1-03
Rear left window monitoring switch (DWA), S102	6100.0-06
Rear LH door contact switch, S16	5126.2-04
Rear lid lock relay, K117	5126.0-03
Rear lid microswitch, S213	5430.1-02
Rear RH door contact switch, S15	5126.2-04
Rear right ABS sensor, B3	3450.0-02
Rear right ABS sensor, B3	3450.1
Rear right brake pad sensor, B17	6211.0-01
Rear right converter, B37	6621.0-01
Rear right door contact, S124	6100.0-04
Rear right door DWA conductor loop, R22	6100.0-06
Rear right flasher unit, H5	6313.0-03
Rear right power window motor, M99	5133.0-05
Rear right power window, S129z	5133.0-04
Rear right speaker, H45	6510.0-00
Rear right speaker, H45	6510.1-02

Rear right window monitoring switch (DWA), S101	6100.0-06
Rear window blower microswitch, S196	6424.0-02
Rear window blower motor, M105	6424.0-02
Rear window blower relay, K99	6424.0-02
Rear window defogger I, E9	6424.0-01
Rear window defogger/antenna	6424.0
Rear wipe/wash interval control unit, A36	6160.1
Relay module, A5	5133.0-02
Remote control ZV/DWA	6610.2
Remote thermometer sensor, B2009	1220.0-00
Remote thermometer sensor, B6232	1210
Remote thermometer sensor, B6232	6211.0
Reversing light switch, S2113	6322.0-00
Reversing light switch, S8511	6322.0-00
Reversing lights	6322.0
Right brake light, H31	6325.0-01
Right catalytic converter thermal sensor, B24	6211.0-09
Right fog light, E27	6312.0-00
Right front high range speaker, H50	6510.0-00
Right front high range speaker, H50	6510.1-02
Right front low range speaker, H51	6510.0-00
Right front low range speaker, H51	6510.1-02
Right front mid-range speaker, H54	6510.1-04
Right headlight beam angle adjust actuator, M81	6312.0-04
Right headlight, E14	6312.0-03
Right headlight, E8	6312.0-03
Right headlight, E8	6314.0-01
Right heat exchanger sensor, B12	6450.7-02
Right high beam, E12	6312.0-03
Right horn, H3	6133.0-00
Right licence plate light, E44	6320.0-00
Right mid-range/high range speaker, H43	6510.1-04
Right outside mirror, Y6	5116.0-01
Right parking light, E19	6314.0-01
Right parking light/licence plate light relay, K25	6314.0-02



Right rear high range speaker, H53	6510.1-04
Right rear lid light, E47	6313.0-03
Right rear lid light, E47	6314.0-01
Right rear lid light, E47	6314.0-04
Right rear lid light, E47	6322.0-00
Right rear lid light, E47	6325.0-01
Right rear lid light, E47	6325.0-02
Right rear low range speaker, H52	6510.1-04
Right reversing light, H28	6322.0-00
Right tail light, H39	6314.0-01
Right vent window motor, M104	5133.0-06
Right windscreen washer jet heater, E52	6169.0-00
Rollover sensor, N24	5430.1-03
Selector lever potentiometer, A140	2460.12-09
Shift lock selector lever lock, Y19	2460.11-00
SMG selector lever, S1134	2460.12
Solenoid clutch, Y2	6450.7-04
Solenoid valve, injection timing device, B2011	1360
Speed sensor EGS, Y8516	2460.12-04
Speedometer reed contact, B10	6211.0-07
Starter	1240.0
Starter, M2025	1240.0-01
Starter, M6510	1240.0-01
Switch for electrically operated convertible soft top, S143	5430.1-01
Symbols	0140.0
Tail light, left, H25	6314.0-01
Tail light, right, H30	6314.0-01
Temperature regulator, A32y	6410.5-00
Temperature sensor, transmission oil, B5238	2460.12-04
Thermal switch (LA Japan), K20	6211.0-09
Thermal switch, heated jets, S198	6169.0-00
Throttle heating, E104	3450.1-02
Throttle potentiometer, R6252	1210
Tilt/slide sunroof control unit, A56	5410.1
Tilt/slide sunroof switch (SHD), S38	5410.1-00

Top Hifi switch, S303y	6510.1-01
Trailer coupling	6328.1
Transmission shift unit, Y2121	2460.3-01
Transmission switch, Y8551	2460.11-01
Transmit/receive module (EWS II), A835	6135.0-00
Turn indicator/low beam selector, S7	6312.0-00
Turn signal/hazard warning system	6313.0
Unloader relay terminal 15, K9	5203.0-00
Unloader relay, terminal 15, K6326	1210
Valve for secondary air pump, Y6164	1210.21-04
VANOS sensor 1 (inlet), B6277	1210.21-06
VANOS sensor 2 (exhaust), B6278	1210.21-06
VANOS valve 1 and 2 (exhaust), Y5220	1210.21-06
VANOS valve 1 and 2 (inlet), Y5210	1210.21-06
VANOS valve 1, Y6275	1210.17-05
Ventilation flap regulating motor, M44	6450.7-03
Volute spring, C101	3234.0-00
Wash water level switch, S64	6581.2-03
Washer pump, M4	6160.1-01
Water valves, Y4	6410.5-00
Window lifter door rear LH (centre console), S128y	5133.0-03
Window lifter door rear LH (door), S41y	5133.0-03
Window lifter door rear RH (centre console), S129y	5133.0-03
Window lifter door rear RH (door), S42y	5133.0-02
Windscreen cowl panel lock microswitch, S231	5430.1-00
Windscreen washer jet heaters	6169.0
Windscreen wiper switch, S5	6160.1-01
Wipe-wash module (Low II), A64	6160.1-03
Wipe/wash module (WWM)	6160.1
Wipe/wash module, A51	6160.1
Wiper motor, M3	6160.1-00
ZKE control unit, A104	6100.0
ZV drive tank flap, M16	5126

Schematics

The schematics divide the entire vehicle electrical system into individual circuits. Interacting electrical components are shown on one common schematic.

Switches and other components are represented in such a way that their general layout and function are self-explicit. They are arranged on the sheet such that the current path can be followed from positive (top) to negative (bottom).

Important: The components and wires are not drawn to scale. For instance, a lead with a length of over 1m can be shown as a lead which is only a few cm long. To ensure clear arrangement, all connectors, line branches and connected components from the fuses to the component and from the component to ground connection are not shown within the individual cells. If required, reference can be made to the cells **0670.3 Fuse Details** and **0670.4 Ground Distribution** where all lines are illustrated with all plug connections, line branches and connected components.

All circuit symbols used are listed and explained in the cell **0140.0 Symbols**.

In cell **7000.0 Component Location Chart** all important connectors, ground points and components are listed in tabular form. It provides a precise description of the component locations in the vehicle.

In cell **7100.0 Component Location Views** the locations of the connectors and components which are difficult to locate are shown in line arts or illustrations. In cell **8000.0 Solder Connector Location Views** all splices are listed in numerical order and illustrations are provided to assist in locating splices on larger harnesses. In cell **8500.0 Connector Views** diagrams of connectors with more than 2 pins are illustrated.

Example

General conventions can be explained based on the following schematic example.

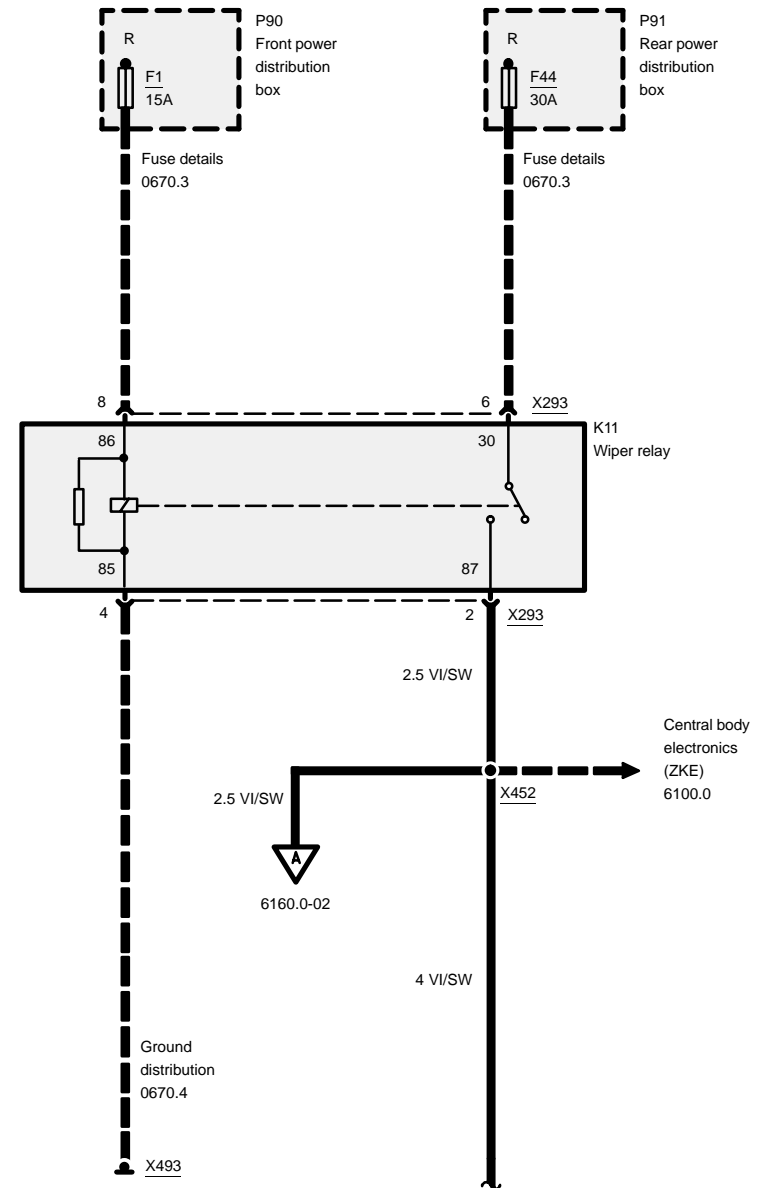



General conventions

1. Switches and relays are always shown in rest position (e.g. K11).
2. A component shown in a dashed frame signifies that the component is illustrated only in part (e.g. P90 and P94).
3. A component shown in a completely drawn frame signifies that the component is illustrated in full (e.g.K11).
4. The dashed line between pin 8 and pin 6 at the connector X293 indicates that both pins belong to the connector X293.
5. The dashed line from fuse 1 to pin 8 of the connector X293 shows the positive supply of the relay K11. If required, refer to cell **0670.3 Fuse details** at fuse F1 for the complete line progression with all plug connections, line branches, wire colours and cross sections.
6. The dashed line with arrow at the connector X452 indicates that several wires lead to the connector X452. All lines leading to the connection are illustrated in cell **6100.0 Central body electronics (ZKE)**. An uninterrupted line with arrow indicates that only this one line leads to another circuit.
7. The dashed line from pin 4 of connector X293 to ground X493 shows the ground supply of the relay K11. If required, refer to cell **0670.4 Ground distribution** at ground X493 for the complete line progression with all plug connections, line branches, wire colours and cross sections.
8. The uninterrupted line from connector X452 with an **A** in the open arrow is continued on Page 6160.0–02.
Termination of the wire 4 VI/SW from connector X452 with a wavy line indicates that the wire is continued on the opposite page.



0140.0 Symbols

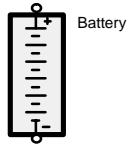

Battery

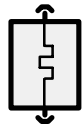

Heating element



Potentiometer Wiper moved by external force

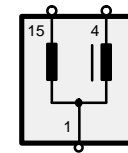

Ignition coil



Fuses



motor with blower or fan



Potentiometer Change by pressure or temperature



Control/performance electronics



Fuse link



Bulb



Diode Current flows in direction of arrow only



Radio



Variable resistor



Z-diode for voltage control



Hall-effect sensor



Automatic cut-out



Overtemperature protection



LED



Transistor switch



Solenoid coil



Permanent magnet motor one speed



Knock sensor



Solenoid valve



Permanent magnet motor two speeds



Oxygen sensor



Heating element

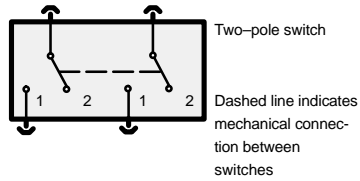
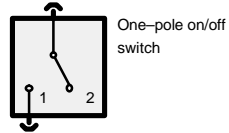
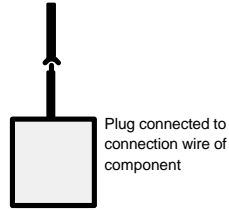
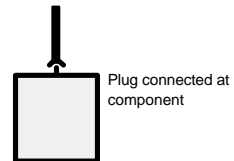
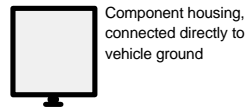
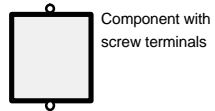
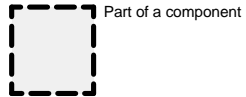
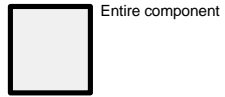

Wire colour	
BL	blue
BR	brown
GE	yellow
GN	green
GR	grey
OR	orange
RS	pink
RT	red
SW	black
VI	violet
WS	white
TR	transparent

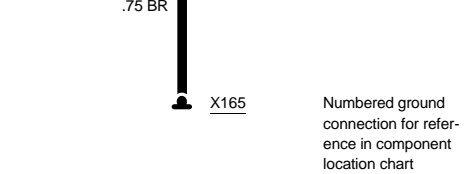
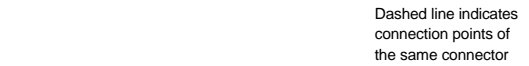
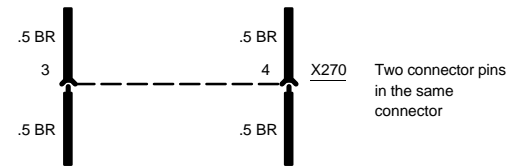
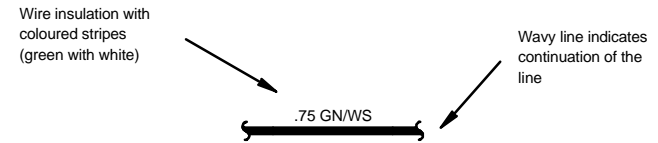
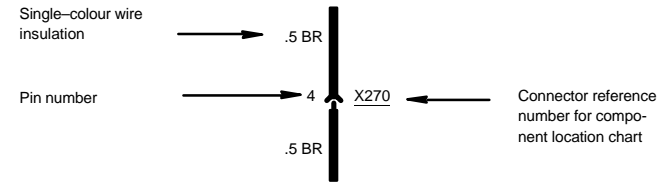

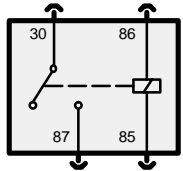

Contact relay

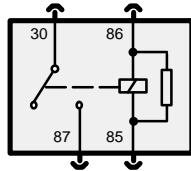

Contact relay with protective resistor

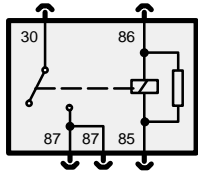

Contact relay with 2 outputs

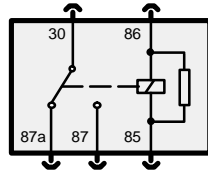

Centre-zero relay with 2 outputs

Terminal number	Designation
30	Relay input
85	Relay output (coil)
86	Relay input (coil)
87	Relay output (switched)
87a	Relay output (non-switched)

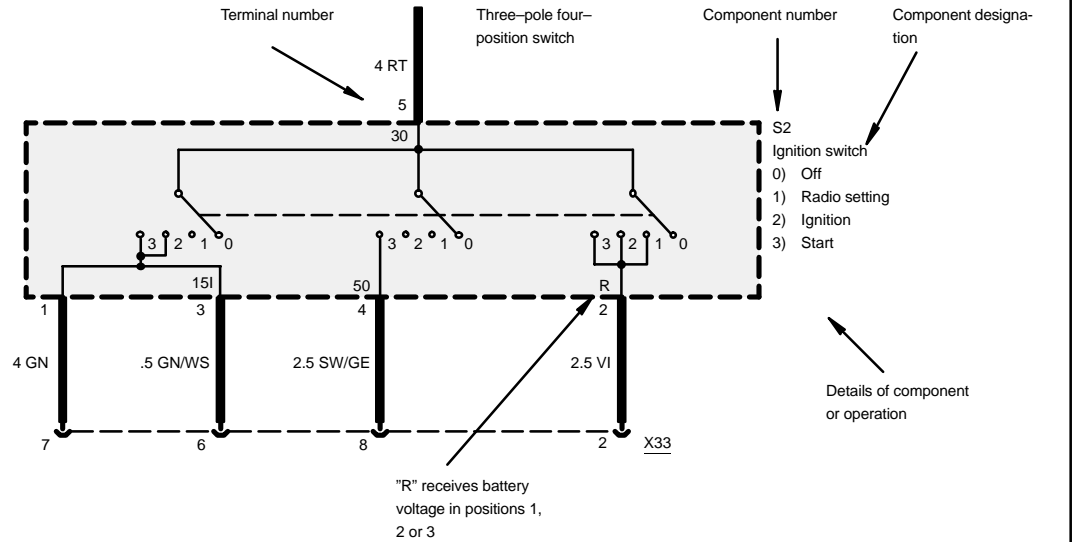

Terminal number	Designation	Terminal number	Designation
50	Battery voltage: Ignition switch in position 3	15I	Battery voltage: Ignition switch in position 2
30	Battery voltage: Supplied constantly	R	Battery voltage: Ignition switch in position 1, 2 or 3
15	Battery voltage: Ignition switch in position 2 or 3	31	Ground

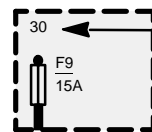

Fuse constantly connected in current path

Terminal number	Designation
30	Battery voltage: Supplied constantly
15	Battery voltage: Ignition switch in position 2 or 3
R	Battery voltage: Ignition switch in position 1, 2 or 3



Symbols

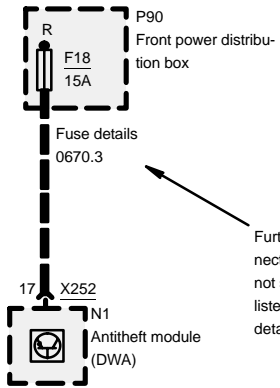

Further circuits connected to fuse 18 are not shown but are listed under "fuse details"

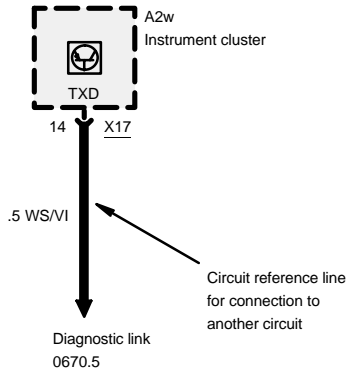

Circuit reference line for connection to another circuit

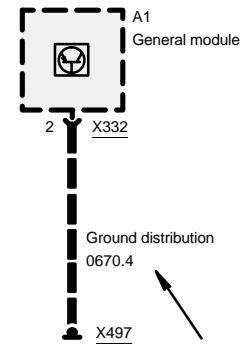

Further circuits connected at ground X497 are not shown but are listed under "ground distribution"

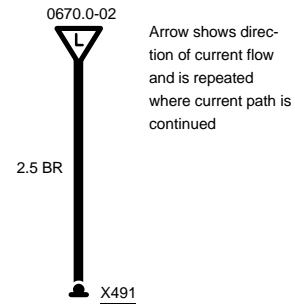
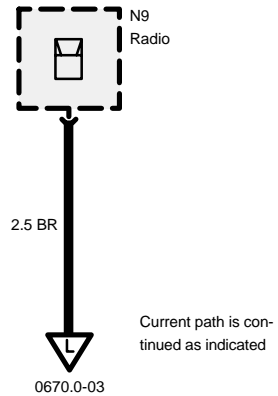



Symbols

Block diagram

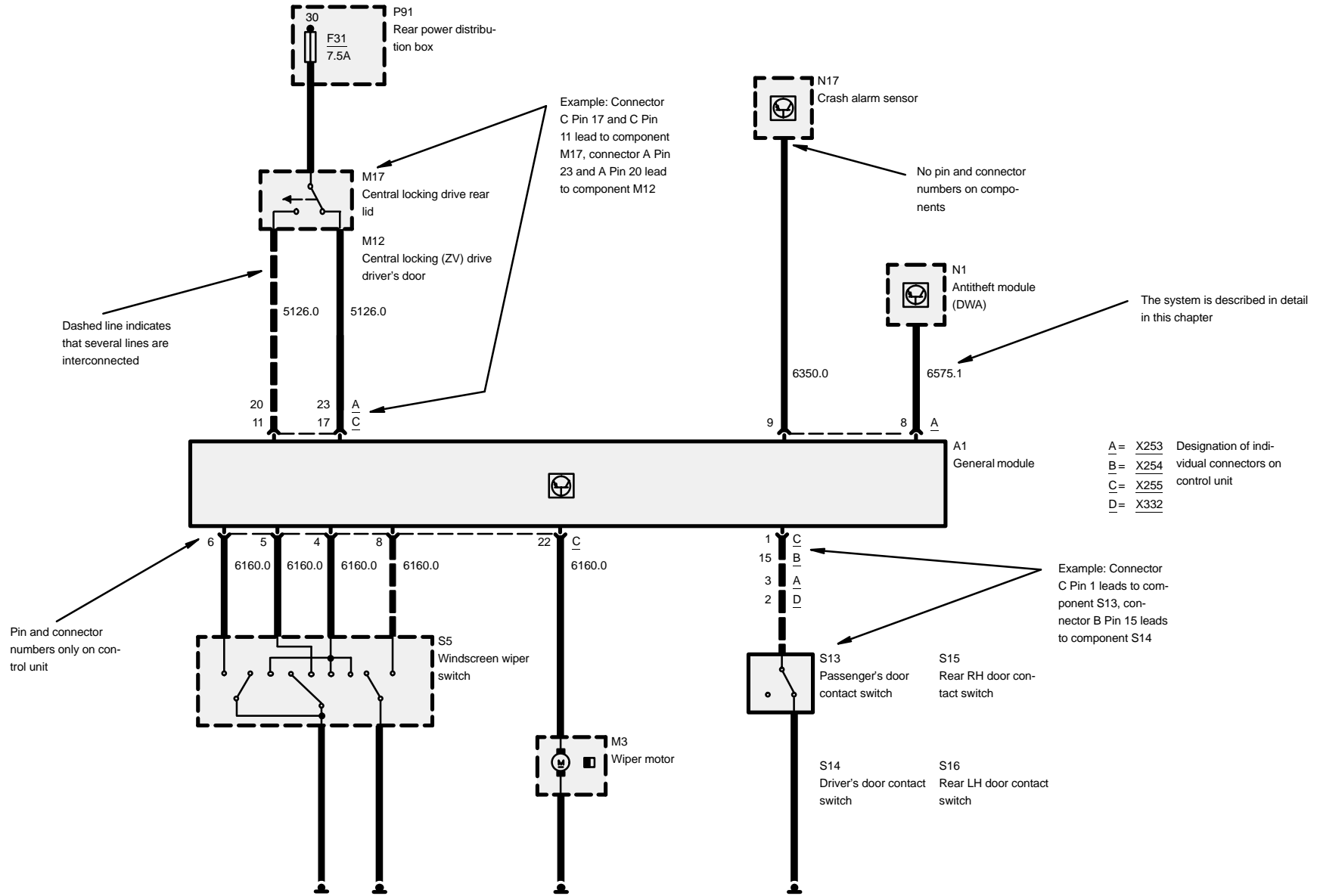



0670.0 Power distribution chart

Petrol-driven vehicle

Front power distribution box

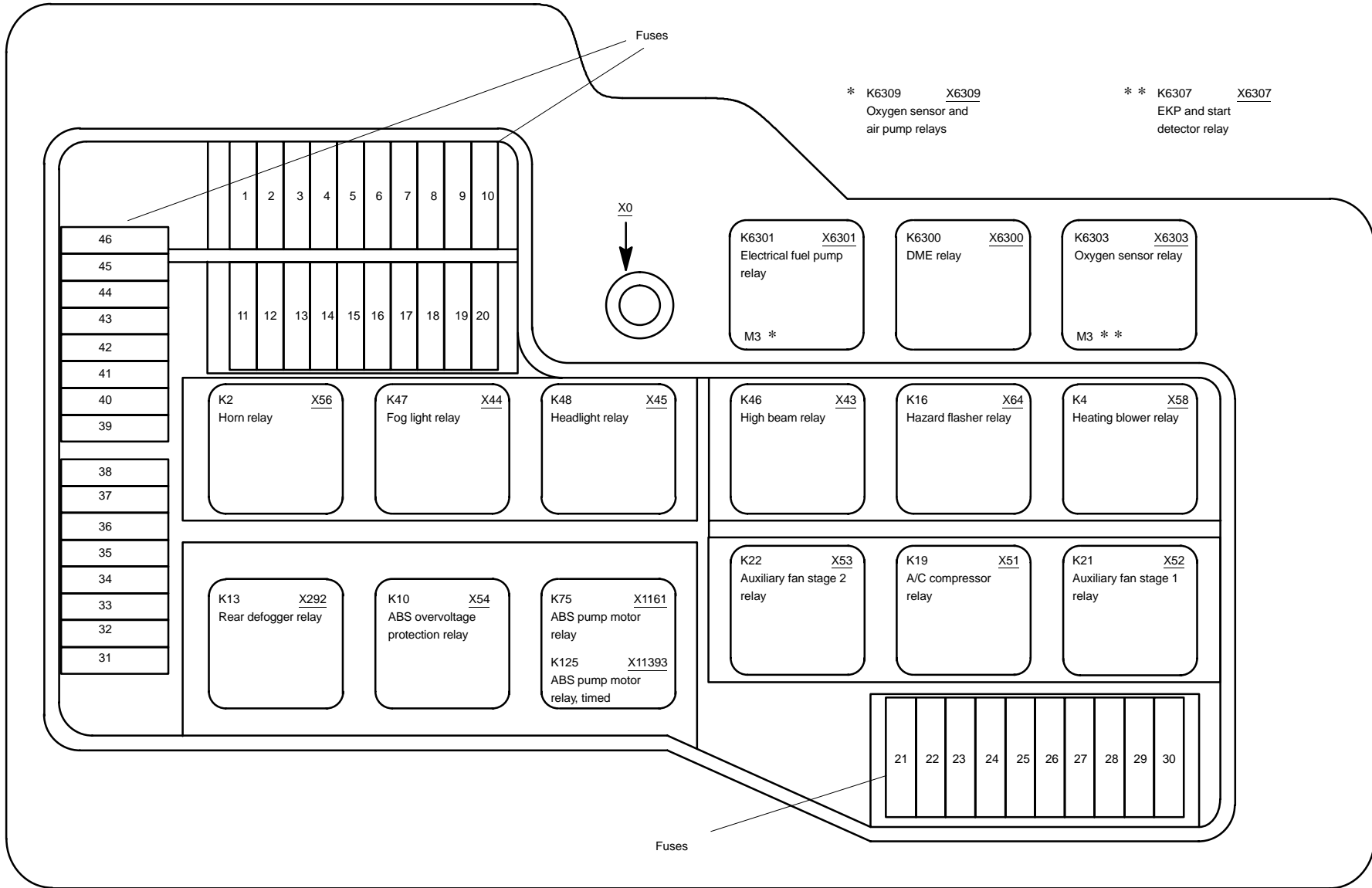



Power distribution chart

Diesel

Front power distribution box

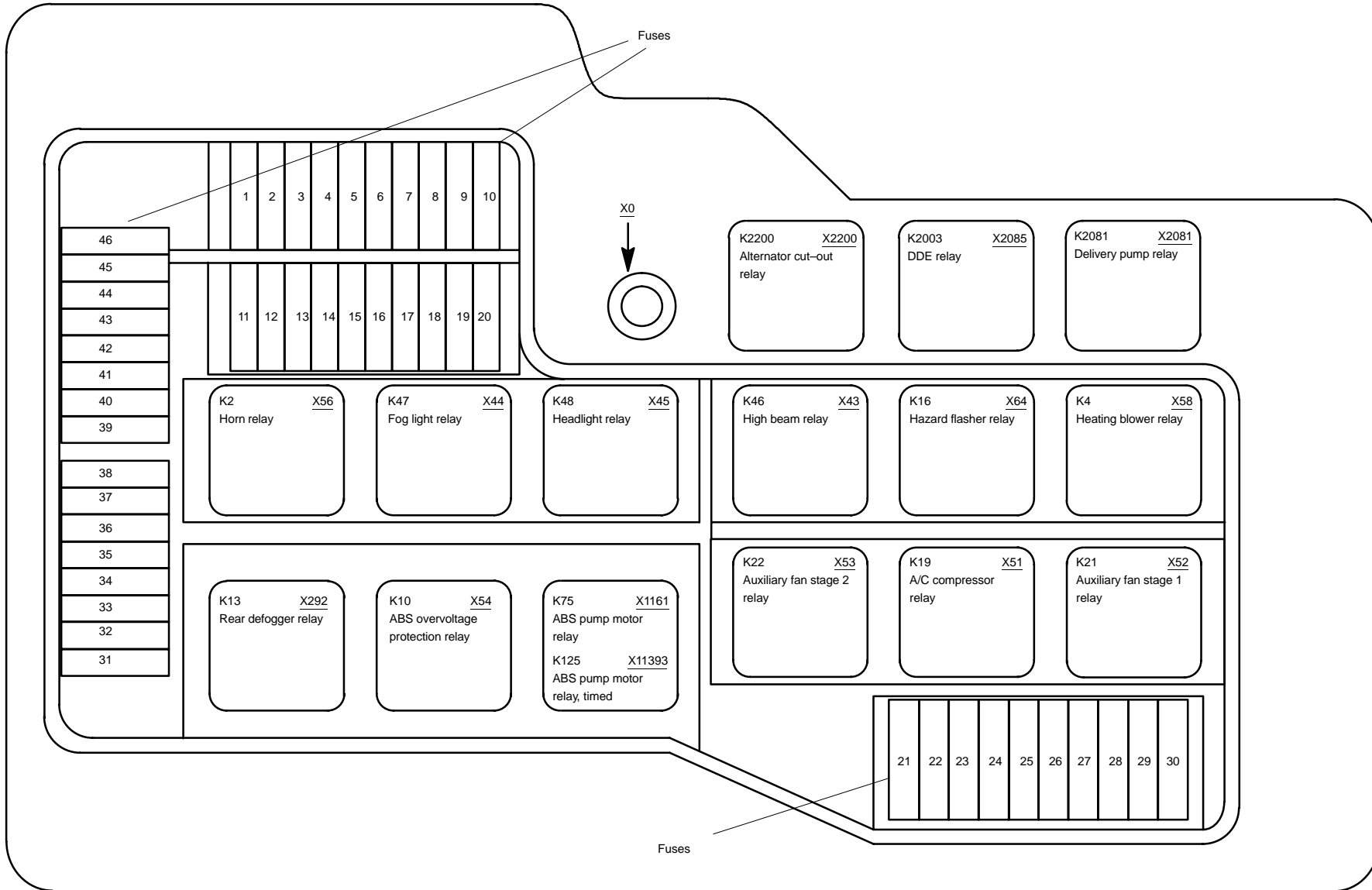



Power distribution chart

Relay carrier under LH side of dash

