

---

---

## FOREWORD

---



This Arctic Cat Service Manual contains service, maintenance, and troubleshooting information for certain 2011 Arctic Cat ATV models (see cover). The complete manual is designed to aid service personnel in service-oriented applications.

Arctic Cat offers additional publications (when they become available) to aid in servicing other ATV models. To service models not included in this manual, please refer to the following publications:

- **2011 Y-12+ Service Manual**
- **2011 T-14 Service Manual**
- **2011 300 DVX/Utility Service Manual**
- **2011 366 Service Manual**
- **2011 700 Diesel Service Manual**

This manual is divided into sections. Each section covers a specific ATV component or system and, in addition to the standard service procedures, includes disassembling, inspecting, and assembling instructions. When using this manual as a guide, the technician should use discretion as to how much disassembly is needed to correct any given condition.

The service technician should become familiar with the operation and construction of each component or system by carefully studying the complete manual. This manual will assist the service technician in becoming more aware of and efficient with servicing procedures. Such efficiency not only helps build consumer confidence but also saves time and labor.

All Arctic Cat ATV publications and decals display the words Warning, Caution, Note, and At This Point to emphasize important information. The symbol  **WARNING** identifies personal safety-related information. Be sure to follow the directive because it deals with the possibility of severe personal injury or even death. A **CAUTION** identifies unsafe practices which may result in ATV-related damage. Follow the directive because it deals with the possibility of damaging part or parts of the ATV. The symbol  **NOTE:** identifies supplementary information worthy of particular attention. The symbol  **AT THIS POINT** directs the technician to certain and specific procedures to promote efficiency and to improve clarity.

At the time of publication, all information, photographs, and illustrations were technically correct. Some photographs used in this manual are used for clarity purposes only and are not designed to depict actual conditions. Because Arctic Cat Inc. constantly refines and improves its products, no retroactive obligation is incurred.

All materials and specifications are subject to change without notice.

Keep this manual accessible in the shop area for reference.

**Product Service and  
Warranty Department  
Arctic Cat Inc.**

## **TABLE OF CONTENTS**

Note: To navigate through this manual, use the PAGE UP/PAGE DOWN buttons on the keyboard, click on the Table of Contents bookmarks on the left side of the screen, or click the blue text below. To return to this page, click the Manual Table of Contents button at the bottom of each page.

### **Section**

**1. General Information/Specifications**

**2. Periodic Maintenance**

**3. Engine/Transmission**

**4. Fuel/Lubrication/Cooling**

**5. Electrical System**

**6. Drive System**

**7. Suspension**

**8. Steering/Frame**

**9. Controls/Indicators**

450  
550  
650  
700  
1000  
**1**

**2**

**3**

**4**

**5**

**6**

**7**

**8**

**9**





# SECTION 1 - GENERAL INFORMATION/ SPECIFICATIONS

---

---

## TABLE OF CONTENTS

---

General Specifications .....	1-2
Torque Specifications .....	1-3
Torque Conversions (ft-lb/N-m) .....	1-5
Tightening Torque (General Bolts) .....	1-5
Break-In Procedure .....	1-5
Gasoline - Oil - Lubricant .....	1-5
Genuine Parts .....	1-6
Preparation For Storage .....	1-6
Preparation After Storage.....	1-7

## General Specifications

450	
CHASSIS	
Brake Type	Hydraulic w/Brake Lever Lock and Auxiliary Brake
Tire Size	Front - 25 x 8-12 Rear - 25 x 10-12
Tire Inflation Pressure	0.35 kg/cm <sup>2</sup> (5 psi)
MISCELLANY	
Gas Tank Capacity	21.6 L (5.7 U.S. gal.) - FIS 20.0 L (5.3 U.S. gal.) - TRV
Coolant Capacity	2.9 L (3.0 U.S. qt)
Rear Drive Capacity	250 ml (8.5 fl oz)*
Front Differential Capacity	275 ml (9.3 fl oz)**
Engine Oil Capacity	2.85 L (3.0 U.S. qt) - Overhaul 2.50 L (2.6 U.S. qt) - Change
Gasoline (recommended)	87 Octane Regular Unleaded
Engine Oil (recommended)	Arctic Cat ACX All Weather (Synthetic)
Differential/Rear Drive Lubricant	SAE Approved 80W-90 Hypoid
Drive Belt Width (minimum)	28.5 mm (1.12 in.)
Brake Fluid	DOT 4
Taillight/Brakelight	12V/8W/27W
Headlight	12V/37W (2)
550/650/700	
CHASSIS	
Brake Type	Hydraulic w/Brake Lever Lock and Auxiliary Brake
Tire Size	Front - 25 x 8-12 Rear - 25 x 10-12 (650 Mud Pro) Front - 28 x 9-14 (650 Mud Pro) Rear - 28 x 9-14 (700 Mud Pro) Front - 28 x 9-14 (700 Mud Pro) Rear - 28 x 11-14
Tire Inflation Pressure	0.35 kg/cm <sup>2</sup> (5 psi)
MISCELLANY	
Gas Tank Capacity	21.6 L (5.7 U.S. gal.) - FIS 21.9 L (5.8 U.S. gal.) - TBX 20.0 L (5.3 U.S. gal.) - TRV/ Cruiser
Coolant Capacity	2.9 L (3.0 U.S. qt)
Differential Capacity	275 ml (9.3 fl oz)*
Rear Drive Capacity	250 ml (8.5 fl oz)**
Engine Oil Capacity	2.5 L (2.6 U.S. qt) - Overhaul 1.9 L (2.0 U.S. qt) - Change
Gasoline (recommended)	87 Octane Regular Unleaded
Engine Oil (recommended)	Arctic Cat ACX All Weather (Synthetic)
Differential/Rear Drive Lubricant	SAE Approved 80W-90 Hypoid
Drive Belt Width (minimum)	35.6 mm (1.40 in.)
Brake Fluid	DOT 4
Taillight/Brakelight	12V/8W/27W
Headlight	12V/27W (2)

1000	
CHASSIS	
Brake Type	Hydraulic w/Brake Lever Lock and Auxiliary Brake
Tire Size	Front - 26 x 9-12 Rear - 26 x 11-12 (Mud Pro) Front - 28 x 9-14 (Mud Pro) Rear - 28 x 11-14 (Cruiser) Front - 25 x 8-12 (Cruiser) Rear - 25 x 10-12
Tire Inflation Pressure	0.35 kg/cm <sup>2</sup> (5 psi)
MISCELLANY	
Gas Tank Capacity	21.6 L (5.7 U.S. gal.) - FIS 20.0 L (5.3 U.S. gal.) - Cruiser/TRV
Coolant Capacity	3.3 L (3.5 U.S. qt)
Differential Capacity	275 ml (9.3 fl oz)*
Rear Drive Capacity	250 ml (8.5 fl oz)**
Engine Oil Capacity	2.6 L (2.75 U.S. qt) - Overhaul 2.1 L (2.25 U.S. qt) - Change
Gasoline (recommended)	87 Octane Regular Unleaded
Engine Oil (recommended)	Arctic Cat ACX All Weather (Synthetic)
Front Differential/Rear Drive Lubricant	SAE Approved 80W-90 Hypoid
Drive Belt Width (minimum)	35.6 mm (1.40 in.)
Brake Fluid	DOT 4
Taillight/Brakelight	12V/8W/27W
Headlight	12V/27W (2)

Specifications subject to change without notice.

\* One inch below plug threads.

\*\* At the plug threads.

## Torque Specifications

EXHAUST COMPONENTS			
Part	Part Bolted To	Torque	
		ft-lb	N-m
Exhaust Pipe	Engine	20	27
Spark Arrester	Muffler	48 in.-lb	5.5
ELECTRICAL COMPONENTS			
Engine/Harness Ground Cap Screw	Crankcase	8	11
Coil (650)*	Frame	12	16
Coil (EFI)	Air Filter Housing	7	10
STEERING COMPONENTS			
Steering Post Bearing Housing	Frame	20	27
Steering Post Bearing Flange	Frame	20	27
Lower Steering Bearing Washer Cap Screw***	Steering Post	40	54
Tie Rod End	Knuckle/Steering Post	30	41
BRAKE COMPONENTS			
Brake Disc*	Hub	15	20
Brake Hose	Caliper	20	27
Brake Hose	Master Cylinder	20	27
Brake Hose	Auxiliary Brake Cylinder	20	27
Master Cylinder (Rear)	Frame	12	16
Hydraulic Caliper	Knuckle (w/"Patch-Lock")	20	27
Master Cylinder Clamp	Master Cylinder	6	8
Brake Pedal	Brake Pedal Axle	25	34
CHASSIS COMPONENTS			
Footrest	Frame (8 mm)	20	27
Footrest	Frame (10 mm)	40	54
SUSPENSION COMPONENTS (Front)			
A-Arm	Frame	50	68
Knuckle	Ball Joint	35	47
Shock Absorber	Frame/Upper A-Arm	50	68
Knuckle	A-Arm	50	68
SUSPENSION COMPONENTS (Rear)			
Shock Absorber (Upper)	Frame	50	68
Shock Absorber (Lower)	Lower A-Arm	20	27
A-Arm	Frame	50	68
Knuckle	A-Arm	35	47
Knuckle (H2)	A-Arm	50	68

DRIVE TRAIN COMPONENTS (450)			
Part	Part Bolted To	Torque	
		ft-lb	N-m
Engine Mounting Through-Bolt	Frame	35	47
Front Differential	Frame/Differential Bracket	38	52
Output Flange	Rear Flange Output Joint	20	27
Pinion Housing	Differential Housing	23	31
Differential Housing Cover***	Differential Housing	23	31
Drive Bevel Gear Nut**	Shaft	72	98
Lock Collar	Differential Housing	125	169
Hub Nut	Shaft/Axle (max)	200	272
Oil Drain Plug	Front Differential/ Rear Drive	45 in.-lb	5
Oil Fill Plug	Front Differential/ Rear Drive	16	22
Oil Drain Plug	Engine	16	22
Rear Drive Input Shaft/Housing	Differential Housing	23	31
Wheel	Hub	40	54
Rear Drive Gear Case	Frame	38	52
Engine Output Shaft**	Rear Gear Case Input Flange	20	27
DRIVE TRAIN COMPONENTS (550/650/700)			
Engine Mounting Through-Bolt	Frame	40	54
Engine (TRV)	Engine Cradle	40	54
Engine Cradle (TRV)**	Rubber Mount	25	34
Rubber Mount (TRV)	Frame Bracket	35	47
Front Differential*	Frame/Differential Bracket	38	52
Output Flange	Rear Flange Output Joint	20	27
Pinion Housing	Differential Housing	23	31
Differential Housing Cover***	Differential Housing	23	31
Drive Bevel Gear Nut***	Shaft	72	98
Differential Gear Case***	Hub	19	26
Lock Collar	Differential Housing	125	169
Hub Nut	Shaft/Axle (max)	200	272
Oil Drain Plug	Front Differential/ Rear Drive	45 in.-lb	5
Oil Fill Plug	Front Differential/ Rear Drive	16	22
Oil Drain Plug	Engine	16	22
Rear Drive Input Shaft/Housing	Differential Housing	23	31
Wheel	Hub	40	54
Rear Drive Gear Case	Frame	38	52
Engine Output Shaft **	Rear Gear Case Input Flange	20	27

\* w/Blue Loctite #243

\*\* w/Red Loctite #271

\*\*\* w/Green Loctite #609

1

DRIVE TRAIN COMPONENTS (1000)			
Part	Part Bolted To	Torque	
		ft-lb	N-m
Engine Mount (Rear)	Frame	45	61
Front Differential	Frame/Differential Bracket	38	52
Rear Gear Case	Frame	38	52
Pinion Housing	Differential Housing	23	31
Differential Housing Cover***	Differential Housing	23	31
Lock Collar	Differential Housing	125	169
Hub Nut	Shaft/Axle (max)	200	272
Oil Drain Plug	Front Differential/ Rear Drive	45 in.-lb	5
Oil Fill Plug	Front Differential/ Rear Drive	16	22
Oil Drain Plug	Engine	16	22
Wheel	Hub	40	54
Rear Drive Input Shaft/Housing	Differential Housing	23	31
Rear Output Drive Flange	Rear Yoke Flange	20	27
Shift Cam Stopper	Shift Stopper	8	11
Shift Cam Plate	Shift Cam Shaft	8	11
Shifter Housing	Crankcase	8	11
Engine Output Shaft**	Rear Gear Case Input Flange	20	27

ENGINE/TRANSMISSION (450)			
Clutch Shoe**	Crankshaft	147	199
Clutch Cover/Housing Assembly	Crankcase	8	11
Left-Side Cover	Crankcase	8	11
Crankcase Half (6 mm)	Crankcase Half	10	13.5
Crankcase Half (8 mm)	Crankcase Half	21	28
Cylinder Nut	Crankcase Half	8	11
Cylinder Head (Cap Screw)	Crankcase	28	38
Cylinder Head Nut	Cylinder	20	27
Valve Cover****	Cylinder Head	8	11
Oil Pump Drive Gear**	Crankshaft	63	86
Driven Pulley Nut**	Driveshaft	147	199
Ground Cable	Engine	8	11
Output Shaft Flange Nut	Output Shaft	59	80
Magneto Rotor Nut	Crankshaft	107	146
Cam Sprocket**	Camshaft	11	15
Cam Chain Tensioner Guide	Cylinder	11	15
Starter Motor	Crankcase	8	11
V-Belt Cover	Crankcase	8	11
Valve Adjuster Jam Nut	Valve Adjuster	7	9.5
Oil Fitting	Engine	8	11
Oil Pump**	Crankcase	8	11
Tappet Cover	Valve Cover	8	11
Cam Chain Tensioner	Cylinder	10	13.5
Magneto Cover	Crankcase	8	11
Rear Driveline	Output Drive Flange	20	27
Movable Drive Face Nut**	Clutch Shaft	147	199
Water Pump Cover/Housing	Magneto Cover	8	11
Water Pump Drive Gear	Crankshaft	28	38

\* w/Blue Loctite #243  
 \*\* w/Red Loctite #271  
 \*\*\* w/Green Loctite #609  
 \*\*\*\* w/Three Bond Sealant

ENGINE/TRANSMISSION (550/650/700)			
Part	Part Bolted To	Torque	
		ft-lb	N-m
Crankshaft Spacer	Crankshaft	25	34
Speed Sensor Housing	Crankcase	8	11
Clutch Shoe**	Crankshaft	221	300
Clutch Cover/Housing Assembly	Crankcase	8	11
Crankcase Half (6 mm)	Crankcase Half	8	11
Crankcase Half (8 mm)	Crankcase Half	20	27
Cylinder Head (Cap Screw)	Crankcase	40	54
Cylinder Head Nut (6 mm)	Cylinder	8	11
Cylinder Head Nut (8 mm)	Cylinder	18	24
Valve Cover****	Cylinder Head	8.5	11.5
Driven Pulley Nut	Driveshaft	80	108
Ground Wire	Engine	8	11
Magneto Cover	Crankcase	8	11
Oil Pump Drive Gear**	Crank Balancer Shaft	63	85
Output Shaft Nut	Output Shaft	59	80
Outer Magneto Cover	Left-Side Cover	6	8
Magneto Rotor Nut	Crankshaft	107	145
Cam Sprocket**	Camshaft	10	13.5
Starter Motor	Crankcase	8	11
V-Belt Cover	Clutch Cover	8	11
Drive Pulley Nut**	Clutch Shaft	165	224
Movable Drive Face Nut**	Clutch Shaft	165	224
Output Yoke Nut	Driven Output Shaft	74	100
Secondary Shaft Bearing Housing	Crankcase Half	28	38

ENGINE/TRANSMISSION (1000)			
Clutch Shoe**	Crankshaft	221	300
Clutch Cover/Housing Assembly	Crankcase	8	11
Crankcase Half	Crankcase Half	8	11
Crankcase Lower Cover (6 mm)	Crankcase	8	11
Crankcase Lower Cover (8 mm)	Crankcase	20	27
Cylinder Head (Cap Screw)	Crankcase	37	50
Cylinder Head (6 mm)	Cylinder	8	11
Cylinder Head (8 mm)	Cylinder	18	24
Cylinder Head Cover	Cylinder Head	8.5	11.5
Driven Pulley Nut**	Driveshaft	80	108
Ground Wire	Engine	8	11
Magneto Cover	Crankcase	8	11
Oil Filler Cover	Crankcase	8	11
Speed Sensor Housing	Crankcase	8	11
Starter Motor	Crankcase	8	11
V-Belt Housing	Crankcase	8	11
Intake Manifold	Cylinder	8	11
Output Shaft Yoke Nut	Output Shaft	59	80
Rotor/Flywheel Nut	Crankshaft	107	145
Cam Sprocket**	Camshaft	10	13.5
V-Belt Cover	Clutch Cover	8	11
Movable Drive Face Nut**	Clutch Shaft	165	224
Oil Pump Cover*	Crankcase	8	11
Oil Strainer Cap	Crankcase	8	11
Shift Cam Stopper	Crankcase	8	11
Shift Cam Stopper Spring	Shift Cam Stopper	8	11
Shift Cam Plate	Shift Cam Shaft	8	11
Shifter Housing	Crankcase	8	11
Secondary Drive Gear Nut	Gear	74	100
Output Yoke Nut	Output Shaft	74	100

\* w/Blue Loctite #243 \*\* w/Red Loctite #271  
 \*\*\* w/Green Loctite #609 \*\*\*\*w/Bond Sealant



## Torque Conversions (ft-lb/N-m)

ft-lb	N-m	ft-lb	N-m	ft-lb	N-m	ft-lb	N-m
1	1.4	26	35.4	51	69.4	76	103.4
2	2.7	27	36.7	52	70.7	77	104.7
3	4.1	28	38.1	53	72.1	78	106.1
4	5.4	29	39.4	54	73.4	79	107.4
5	6.8	30	40.8	55	74.8	80	108.8
6	8.2	31	42.2	56	76.2	81	110.2
7	9.5	32	43.5	57	77.5	82	111.5
8	10.9	33	44.9	58	78.9	83	112.9
9	12.2	34	46.2	59	80.2	84	114.2
10	13.6	35	47.6	60	81.6	85	115.6
11	15	36	49	61	83	86	117
12	16.3	37	50.3	62	84.3	87	118.3
13	17.7	38	51.7	63	85.7	88	119.7
14	19	39	53	64	87	89	121
15	20.4	40	54.4	65	88.4	90	122.4
16	21.8	41	55.8	66	89.8	91	123.8
17	23.1	42	57.1	67	91.1	92	125.1
18	24.5	43	58.5	68	92.5	93	126.5
19	25.8	44	59.8	69	93.8	94	127.8
20	27.2	45	61.2	70	95.2	95	129.2
21	28.6	46	62.6	71	96.6	96	130.6
22	29.9	47	63.9	72	97.9	97	131.9
23	31.3	48	65.3	73	99.3	98	133.3
24	32.6	49	66.6	74	100.6	99	134.6
25	34	50	68	75	102	100	136

## Tightening Torque (General Bolts)

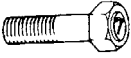
Type of Bolt	Thread Diameter A (mm)	Tightening Torque
(Conventional or 4 Marked Bolt) 	5	12-36 in.-lb
	6	36-60 in.-lb
	8	7-11 ft-lb
	10	16-25 ft-lb
(7 Marked Bolt) 	5	24-48 in.-lb
	6	6-8 ft-lb
	8	13-20 ft-lb
	10	29-43 ft-lb

## Break-In Procedure

A new ATV and an overhauled ATV engine require a “break-in” period. The first 10 hours (or 200 miles) are most critical to the life of this ATV. Proper operation during this break-in period will help assure maximum life and performance from the ATV.

During the first 10 hours (or 200 miles) of operation, always use less than 1/2 throttle. Varying the engine RPM during the break-in period allows the components to “load” (aiding the mating process) and then “unload” (allowing components to cool). Although it is essential to place some stress on the engine components during break-in, care should be taken not to overload the engine too often. Do not pull a trailer or carry heavy loads during the 10-hour break-in period.

When the engine starts, allow it to warm up properly. Idle the engine several minutes until the engine has reached normal operating temperature. Do not idle the engine for excessively long periods of time.

During the break-in period, a maximum of 1/2 throttle is recommended; however, brief full-throttle accelerations and variations in driving speeds contribute to good engine break-in.

After the completion of the break-in period, the engine oil and oil filter should be changed. Other maintenance after break-in should include checking of all prescribed adjustments and tightening of all fasteners (see Periodic Maintenance Chart in Section 1).

## Gasoline - Oil - Lubricant

### RECOMMENDED GASOLINE

The recommended gasoline to use is 87 minimum octane regular unleaded. In many areas, oxygenates (either ethanol or MTBE) are added to the gasoline. Oxygenated gasolines containing up to 10% ethanol, 5% methane, or 5% MTBE are acceptable gasolines.

When using ethanol blended gasoline, it is not necessary to add a gasoline antifreeze since ethanol will prevent the accumulation of moisture in the fuel system.

### CAUTION

Do not use white gas. Only Arctic Cat approved gasoline additives should be used.

## RECOMMENDED ENGINE/ TRANSMISSION OIL

### CAUTION

Any oil used in place of the recommended oil could cause serious engine damage. Do not use oils which contain graphite or molybdenum additives. These oils can adversely affect clutch operation. Also, not recommended are racing, vegetable, non-detergent, and castor-based oils.

The recommended oil to use is Arctic Cat ACX All Weather synthetic engine oil, which has been specifically formulated for use in this Arctic Cat engine. Although Arctic Cat ACX All Weather synthetic engine oil is the only oil recommended for use in this engine, use of any API certified SM 5W-50 oil is acceptable.

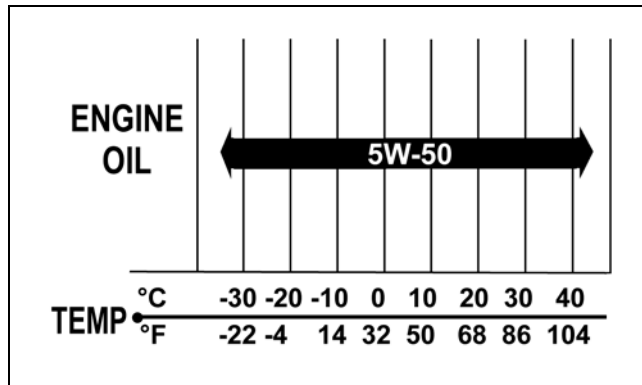

OILCHART1

## RECOMMENDED FRONT DIFFERENTIAL/REAR DRIVE LUBRICANT

The recommended lubricant is Arctic Cat Gear Lube or an equivalent gear lube which is SAE approved 80W-90 hypoid. This lubricant meets all of the lubrication requirements of the Arctic Cat ATV front differentials and rear drives.

### CAUTION

Any lubricant used in place of the recommended lubricant could cause serious front differential/rear drive damage.

## FILLING GAS TANK

### ⚠ WARNING

Always fill the gas tank in a well-ventilated area. Never add fuel to the ATV gas tank near any open flames or with the engine running. DO NOT SMOKE while filling the gas tank.

Since gasoline expands as its temperature rises, the gas tank must be filled to its rated capacity only. Expansion room must be maintained in the tank particularly if the tank is filled with cold gasoline and then moved to a warm area.

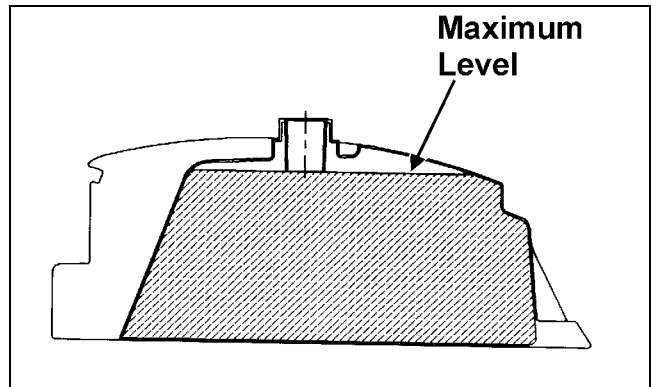

ATV0049B

### ⚠ WARNING

Do not overflow gasoline when filling the gas tank. A fire hazard could materialize. Always allow the engine to cool before filling the gas tank.

### ⚠ WARNING

Do not over-fill the gas tank.

Tighten the gas tank cap securely after filling the tank.

## Genuine Parts

When replacement of parts is necessary, use only genuine Arctic Cat ATV parts. They are precision-made to ensure high quality and correct fit. Refer to the appropriate Illustrated Parts Manual for the correct part number, quantity, and description.

## Preparation For Storage

### CAUTION

Prior to storing the ATV, it must be properly serviced to prevent rusting and component deterioration.

Arctic Cat recommends the following procedure to prepare the ATV for storage.

1. Clean the seat cushion (cover and base) with a damp cloth and allow it to dry.
2. Clean the ATV thoroughly by washing dirt, oil, grass, and other foreign matter from the entire ATV. Allow the ATV to dry thoroughly. DO NOT get water into any part of the engine or air intake.
3. Either drain the gas tank or add Fuel Stabilizer to the gas in the gas tank. Remove the air filter housing cover and air filter. Start the engine and allow it to idle; then using Arctic Cat Engine Storage Preserver, rapidly inject the preserver into the air filter opening for a period of 10 to 20 seconds; then stop the engine. Install the air filter and housing cover.

**CAUTION**

If the interior of the air filter housing is dirty, clean the area before starting the engine.

4. On the 650 drain the carburetor float chamber.
5. Plug the exhaust hole in the exhaust system with a clean cloth.
6. Apply light oil to the upper steering post bushing and plungers of the shock absorbers.
7. Tighten all nuts, bolts, cap screws, and screws. Make sure rivets holding components together are tight. Replace all loose rivets. Care must be taken that all calibrated nuts, cap screws, and bolts are tightened to specifications.
8. Fill the cooling system to the bottom of the stand pipe in the radiator neck with properly mixed coolant.
9. Disconnect the battery cables; then remove the battery, clean the battery posts and cables, and store in a clean, dry area.
10. Store the ATV indoors in a level position.

**CAUTION**

Avoid storing outside in direct sunlight and avoid using a plastic cover as moisture will collect on the ATV causing rusting.

---

## Preparation After Storage

---

Taking the ATV out of storage and correctly preparing it will assure many miles and hours of trouble-free riding. Arctic Cat recommends the following procedure to prepare the ATV.

1. Clean the ATV thoroughly.
2. Clean the engine. Remove the cloth from the exhaust system.
3. Check all control wires and cables for signs of wear or fraying. Replace if necessary.
4. Change the engine/transmission oil and filter.
5. Check the coolant level and add properly mixed coolant as necessary.
6. Charge the battery; then install. Connect the battery cables.

**CAUTION**

The ignition switch must be in the OFF position prior to installing the battery or damage may occur to the ignition system.

**CAUTION**

Connect the positive battery cable first; then the negative.

7. Check the entire brake systems (fluid level, pads, etc.), all controls, headlights, taillight, brakelight, and headlight aim; adjust or replace as necessary.
8. Tighten all nuts, bolts, cap screws, and screws making sure all calibrated nuts, cap screws, and bolts are tightened to specifications.
9. Check tire pressure. Inflate to recommended pressure as necessary.
10. Make sure the steering moves freely and does not bind.
11. Check the spark plug(s). Clean or replace as necessary.

1

# SECTION 2 - PERIODIC MAINTENANCE

---

---

## TABLE OF CONTENTS

---

Periodic Maintenance Chart.....	2-2
Periodic Maintenance.....	2-3
Lubrication Points.....	2-3
Air Filter.....	2-3
Valve/Tappet Clearance.....	2-4
Testing Engine Compression.....	2-5
Spark Plug(s).....	2-6
Muffler/Spark Arrester.....	2-6
Engine/Transmission Oil - Filter - Strainer.....	2-6
Liquid Cooling System.....	2-8
Front Differential/Rear Drive Lubricant.....	2-9
Nuts/Bolts/Cap Screws.....	2-10
Headlights/Taillight-Brakelight.....	2-10
Shift Lever.....	2-12
Frame/Welds/Racks.....	2-12
Hydraulic Brake Systems.....	2-12
Burnishing Brake Pads.....	2-14
Checking/Replacing V-Belt.....	2-14



## Periodic Maintenance Chart

A = Adjust I = Inspect  
 C = Clean L = Lubricate  
 D = Drain R = Replace  
 T = Tighten

Item	Initial Service After Break-In (First Month or 100 Miles)	Every Day	Every Month or Every 100 Miles	Every 3 Months or Every 300 Miles	Every 6 Months or Every 500 Miles	Every Year or Every 1500 Miles	As Needed
Battery	I		I				C
Fuses				I			R
Air Filter/Drain Tube	I	I	C*				R
Valve/Tappet Clearance	I				I		A
Engine Compression						I	
Spark Plug(s)	I			I			R (4000 Mi or 18 Mo)
Muffler/Spark Arrester					C		R
Gas/Vent Hoses	I	I					R (2 Yrs)
Throttle Cable	I	I			C-L		A-R
Carburetor Float Chamber (650)				D*			
Engine Idle RPM (650)	I				I		A
Engine-Transmission Oil Level		I					A
Engine-Transmission Oil/Filter	R			R*/R**/R***			R
Oil Strainer	I				I		C
Front Differential/Rear Drive Lubricant	I		I				R (4 Yrs)
Tires/Air Pressure	I	I					R
Steering Components	I	I		I			R
V-Belt	I				I		R
Suspension (Ball joint boots, drive axle boots front and rear, tie rods, differential and rear drive bellows)	I	I					R
Nuts/Cap Screws/Screws	I		I				T
Ignition Timing						I	
Headlight/Taillight-Brakelight	I	I					R
Switches	I	I					R
Shift Lever					I		A-L
Handlebar Grips		I					R
Handlebar	I	I					R
Gauges/Indicators	I	I					R
Frame/Welds/Racks	I				I		
Electrical Connections	I				I		C
Complete Brake System (Hydraulic & Auxiliary)	I	I		C			L-R
Brake Pads	I			I*			R
Brake Fluid	I			I			R (2 Yrs)
Brake Hoses	I			I			R (4 Yrs)
Coolant/Cooling System	I		I				R (2 Yrs)

\* Service/Inspect more frequently when operating in adverse conditions.

\*\* When using an API certified SM 5W-50 oil.

\*\*\* When using Arctic Cat ACX All Weather synthetic oil, oil change interval and strainer inspection can be increased to every 1,000 miles or every year.

## Periodic Maintenance

This section has been organized into sub-sections which show common maintenance procedures for the Arctic Cat ATV.

■NOTE: Arctic Cat recommends the use of new gaskets, lock nuts, and seals and lubricating all internal components when servicing the engine/transmission.

■NOTE: Some photographs and illustrations used in this section are used for clarity purposes only and are not designed to depict actual conditions.

■NOTE: Critical torque specifications are located in Section 1.

### SPECIAL TOOLS

A number of special tools must be available to the technician when performing service procedures in this section.

Description	p/n
Compression Tester Kit	0444-213
Oil Filter Wrench	0644-389
Tachometer	0644-275
Timing Light	0644-296
Valve Clearance Adjuster	0444-255

■NOTE: Special tools are available from the Arctic Cat Service Parts Department.

## Lubrication Points

It is advisable to lubricate certain components periodically to ensure free movement. Apply light oil to the components using the following list as reference.

- A. Throttle Lever Pivot/Cable Ends
- B. Brake Lever Pivot/Cable Ends
- C. Auxiliary Brake Cable Ends
- D. Shift Lever Cable End
- E. Idle RPM Screw (650)

## Air Filter

Use the following procedure to remove the filter and inspect and/or clean it.

1. Remove the fasteners securing the storage compartment and remove the storage compartment.
2. Remove the air filter housing cover and the air filter/frame assembly.

3. Remove the foam element from the frame making sure not to tear the element.

450



F1515

550/650/700

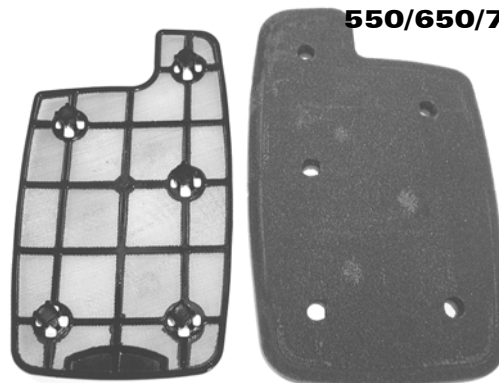

CD747

1000

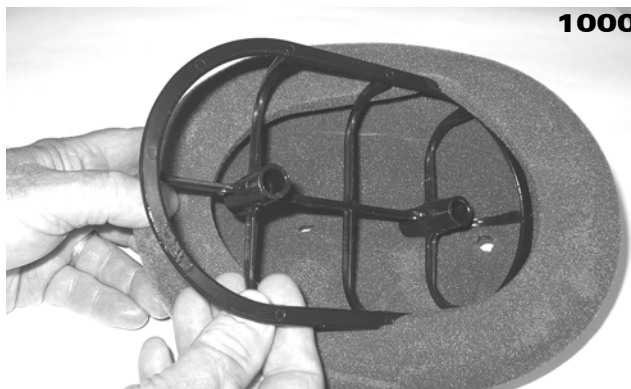

GZ019

4. Fill a wash pan larger than the element with a non-flammable solvent; then dip the element in the solvent and wash it.

■NOTE: Foam Air Filter Cleaner and Foam Air Filter Oil are available from Arctic Cat.

5. Squeeze the element by pressing it between the palms of both hands to remove excess solvent. Do not twist or ring the element or it will develop cracks.
6. Dry the element.
7. Put the element in a plastic bag; then pour in air filter oil and work the oil into the element.
8. Squeeze the element to remove excess oil.

**CAUTION**

A torn air filter can cause damage to the ATV engine. Dirt and dust may get inside the engine if the element is torn. Carefully examine the element for tears before and after cleaning it. Replace the element with a new one if it is torn.

9. Clean any dirt or debris from inside the air cleaner.
10. Install the air filter/frame assembly and cover.
11. Install the storage compartment and cover.

**CHECKING AND CLEANING DRAINS**

1. Inspect the drains beneath the main housing for debris and for proper sealing.

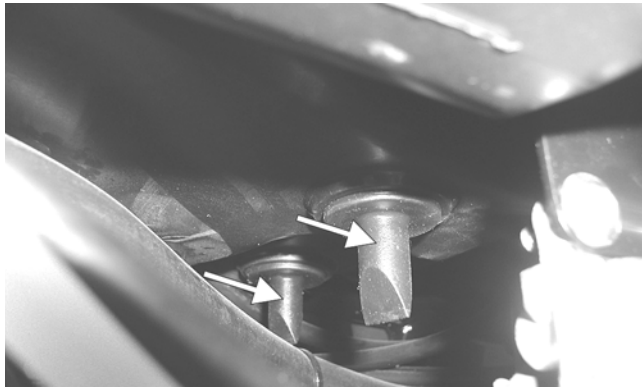

KX045A

2. Replace any drain that is cracked or shows any signs of hardening or deterioration.

**CAUTION**

The drain to the right is the clean air section of the filter housing. Any leak of this drain will allow dirt into the engine intake causing severe engine damage.

3. Wipe any accumulation of oil or gas from the filter housing and drains.

**Valve/Tappet Clearance**

To check and adjust valve/tappet clearance, use the following procedure.

1. Remove the timing inspection plug; then remove the tappet covers and spark plug(s) (for more detailed information, see Section 3 - Servicing Top-Side Components).

**NOTE:** On the H2 models, remove the crankshaft end cap and install the special cap screw (left-hand threads) to rotate the engine.

2. Rotate the crankshaft to the TDC position on the compression stroke (front cylinder on the H2 models).



GZ063

**NOTE:** At this point, the rocker arms and adjuster screws must not have pressure on them.

**Feeler Gauge Procedure**

- A. Using a feeler gauge, check each valve/tappet clearance. If clearance is not within specifications, loosen the jam nut and rotate the tappet adjuster screw until the clearance is within specifications. Tighten each jam nut securely after completing the adjustment.

**CAUTION**

The feeler gauge must be positioned at the same angle as the valve and valve adjuster for an accurate measurement of clearance. Failure to measure the valve clearance accurately could cause valve component damage.

**VALVE/TAPPET CLEARANCE**

Intake	0.101 mm (0.004 in.)
Exhaust	0.152 mm (0.006 in.)

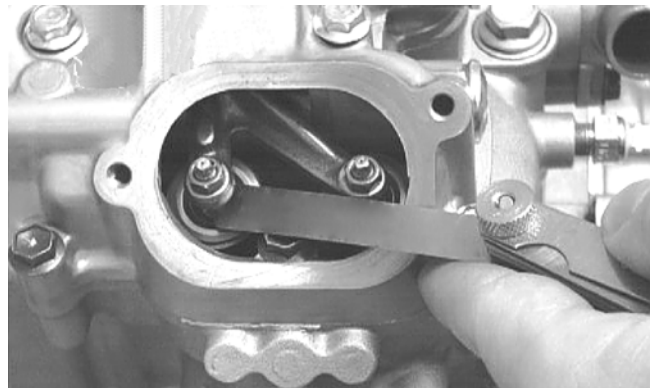

CC007DC

- B. On the H2 models, rotate the engine 270° to the TDC position of the rear cylinder; then repeat step A.



GZ059

### Valve Adjuster Procedure

■NOTE: The seat, storage compartment cover assembly, compartment box, air filter/filter housing, and left-side/right-side splash panels must be removed for this procedure.

- A. Place Valve Clearance Adjuster onto the jam nut securing the tappet adjuster screw; then rotate the valve adjuster dial clockwise until the end is seated in the tappet adjuster screw.
- B. While holding the valve adjuster dial in place, use the valve adjuster handle and loosen the jam nut; then rotate the tappet adjuster screw clockwise until friction is felt.
- C. Align the valve adjuster handle with one of the marks on the valve adjuster dial.
- D. While holding the valve adjuster handle in place, rotate the valve adjuster dial counterclockwise until proper valve/tappet clearance is attained.

■NOTE: Refer to the appropriate specifications in Feeler Gauge Procedure sub-section for the proper valve/tappet clearance.

■NOTE: Rotating the valve adjuster dial counterclockwise will open the valve/tappet clearance by 0.05 mm (0.002 in.) per mark.

- E. While holding the adjuster dial at the proper clearance setting, tighten the jam nut securely with the valve adjuster handle.
  - F. Rotate the engine 270° to the TDC position of the rear cylinder; then repeat steps A-E for the rear cylinder.
3. Install the timing inspection plug; then on the H2 models, remove the cap screw and install the crankcase end cap.
  4. Place the tappet covers into position making sure the proper cap screws are with the proper cover. Tighten the cap screws securely.
  5. Install the spark plug(s).

## Testing Engine Compression

To test engine compression, use the following procedure.

1. Remove the high tension lead(s) from the spark plug(s).
2. Using compressed air, blow any debris from around the spark plug(s).

### ⚠ WARNING

Always wear safety glasses when using compressed air.

3. Remove the spark plug(s); then attach the high tension lead(s) to the plug(s) and ground the plug(s) on the cylinder head(s) well away from the spark plug hole(s).

2

4. Attach the Compression Tester Kit.

■NOTE: The engine should be warm (operating temperature) and the battery full charged for an accurate compression test. Throttle must be in the wide-open throttle (WOT) position. In the event the engine can not be run, cold values are included.

5. While holding the throttle lever in the full-open position, crank the engine over with the electric starter until the gauge shows a peak reading (five to 10 compression strokes).

COMPRESSION		
Model	PSI Hot (WOT)	PSI Cold (WOT)
450	95-115	N/A
550	120-140	80-120
650/700	125-145	100-140
1000 (Front)	125-145	80-120
1000 (Rear)	165-185	150-190

6. If compression is abnormally low, inspect the following items.
  - A. Verify starter cranks engine over at normal speed (approximately 400 RPM).
  - B. Gauge functioning properly.
  - C. Throttle lever in the full-open position.
  - D. Valve/tappet clearance correct.
  - E. Valve not bent or burned.
  - F. Valve seat not burned.

■NOTE: To service valves, see Section 3.

7. Pour 29.5 ml (1 fl oz) of oil into the spark plug hole, reattach the gauge, and retest compression.
8. If compression is now evident, service the piston rings (see Section 3).



## Spark Plug(s)

A light brown insulator indicates that a plug is correct. A white or dark insulator indicates that the engine may need to be serviced or the carburetor (if equipped) may need to be adjusted. To maintain a hot, strong spark, keep the plug free of carbon.

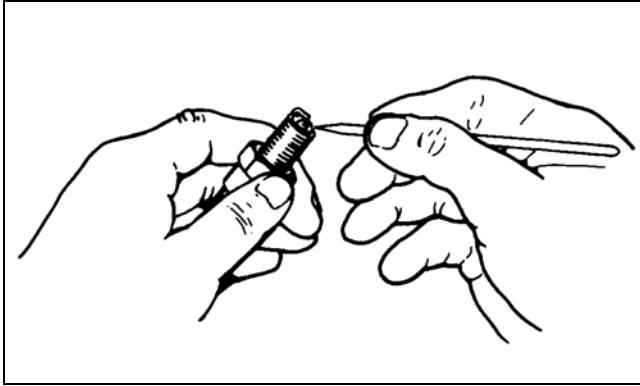

ATV-0051

### CAUTION

Before removing a spark plug, be sure to clean the area around the spark plug. Dirt could enter engine when removing or installing the spark plug.

Adjust the gap to 0.7-0.8 mm (0.028-0.032 in.) for proper ignition. Use a feeler gauge to check the gap.

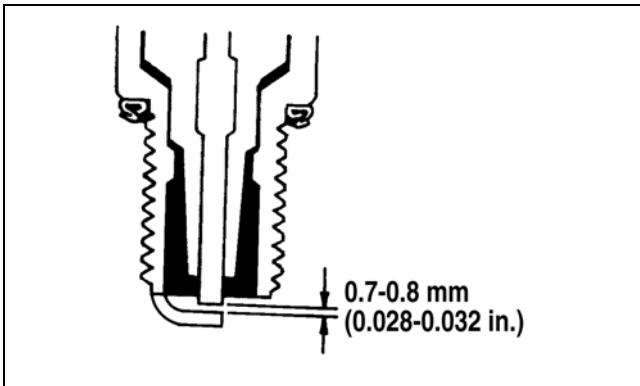

ATV0052C

When installing the spark plug, be sure to tighten it securely. A new spark plug should be tightened 1/2 turn once the washer contacts the cylinder head. A used spark plug should be tightened 1/8 - 1/4 turn once the washer contacts the cylinder head.

## Muffler/Spark Arrester

At the intervals shown in the Periodic Maintenance Chart, clean the spark arrester using the following procedure.

### ⚠ WARNING

Wait until the muffler cools to avoid burns.

[www.mymowerparts.com](http://www.mymowerparts.com)

1. Remove the three cap screws securing the spark arrester assembly to the muffler; then loosen and remove the arrester.

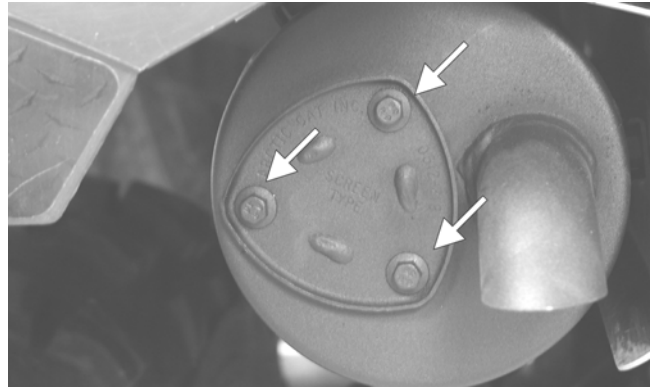

CF105A

2. Using a suitable brush, clean the carbon deposits from the screen taking care not to damage the screen.

■ **NOTE:** If the screen or gasket is damaged in any way, it must be replaced.

3. Install the spark arrester assembly with gasket; then secure with the three cap screws. Tighten to 48 in.-lb.

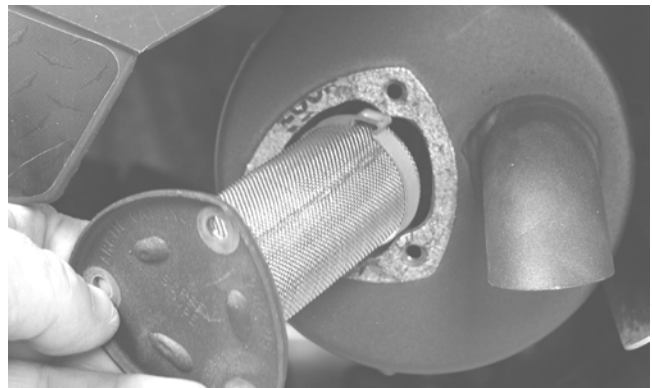

CF104

## Engine/Transmission Oil - Filter - Strainer

### OIL - FILTER

The engine should always be warm when the oil is changed so the oil will drain easily and completely.

1. Park the ATV on level ground.
2. Remove the oil level stick/filler plug.

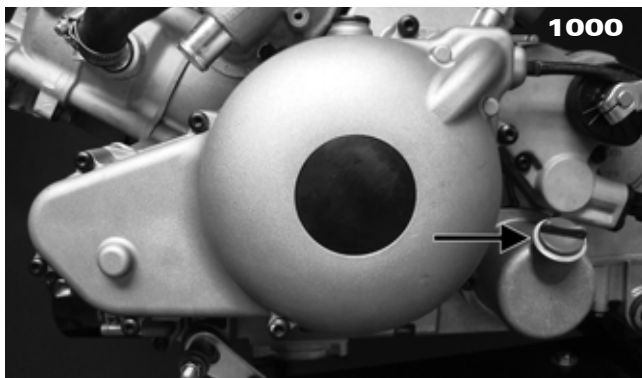
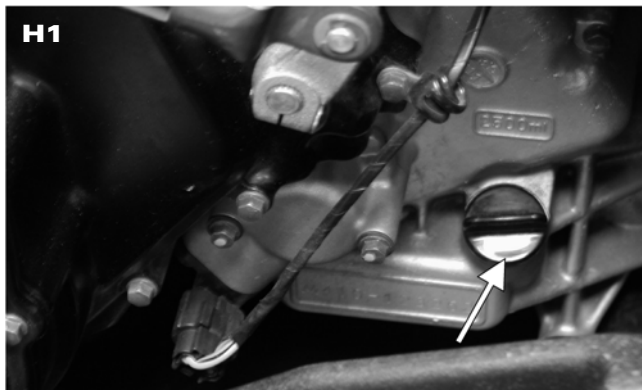

3. Remove the drain plug from the bottom of the engine and drain the oil into a drain pan.

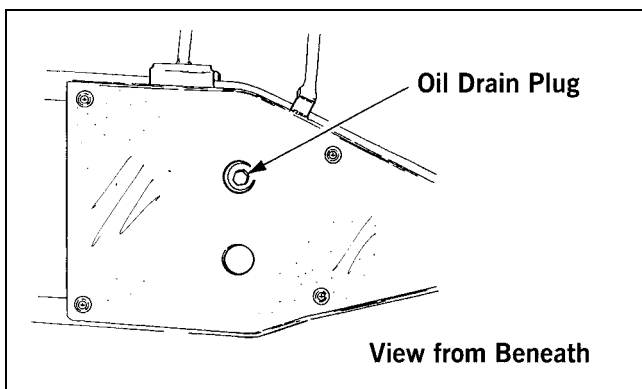

4. Remove the oil filter plug from the filter mounting boss (located on the front side of the transmission case) and allow the filter to drain completely. Install the plug and tighten securely.

5. Using the adjustable Oil Filter Wrench and a suitable wrench, remove the old oil filter.

**NOTE:** Clean up any excess oil after removing the filter.

6. Apply oil to a new filter O-ring and check to make sure it is positioned correctly; then install the new oil filter. Tighten securely.

**NOTE:** Install a new O-ring each time the filter is replaced.

7. Install the engine drain plug and tighten to 16 ft-lb. Pour the specified amount of the recommended oil in the filler hole. Install the oil level stick/filler plug.

**CAUTION**

Any oil used in place of the recommended oil could cause serious engine damage. Do not use oils which contain graphite or molybdenum additives. These oils can adversely affect clutch operation. Also, not recommended are racing, vegetable, non-detergent, and castor-based oils.

8. Start the engine (while the ATV is outside on level ground) and allow it to idle for a few minutes.

9. Turn the engine off and wait approximately one minute.

10. Remove the oil level stick and wipe it with a clean cloth.

11. Install the oil level stick and thread into the engine case.

12. Remove the oil level stick; the oil level must be within the operating range but not exceeding the upper mark.

**2**



GZ461A

**CAUTION**

Do not over-fill the engine with oil. Always make sure that the oil level is not above the upper mark.

13. Inspect the area around the drain plug and oil filter for leaks.

**STRAINER**

1. Remove the belly panel.

2. Remove the cap screws securing the oil strainer cap; then remove the cap.

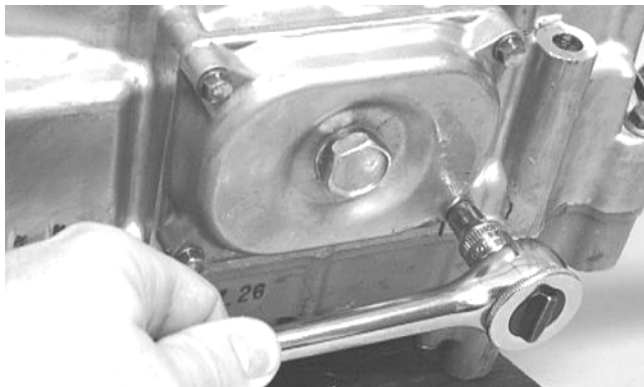

CC091D

- Remove the two cap screws securing the strainer; then remove the strainer.

■NOTE: Thoroughly clean any sealant from the oil strainer cap.

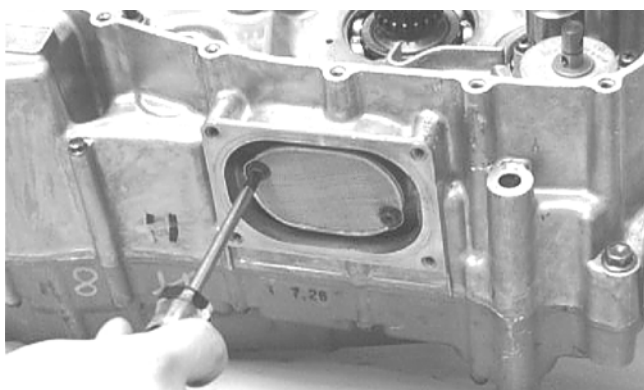

CC163D

### AT THIS POINT

To check/service oil strainer, see Section 3.

- Place the oil strainer into position beneath the crankcase and secure with the cap screws. Tighten securely.
- Place the strainer cap into position on the strainer making sure silicone sealant is applied; then secure with the cap screws. Tighten securely.



CC091D

- Install the belly panel.

## Liquid Cooling System

■NOTE: Debris in front of the engine or packed between the cooling fins of the radiator can reduce cooling capability. Using a garden hose, wash the radiator to remove any debris preventing air flow.

### CAUTION

Arctic Cat does not recommend using a pressure washer to clean the radiator core. The pressure may bend or flatten the fins causing restricted air flow, and electrical components on the radiator could be damaged. Use only a garden hose with spray nozzle at normal tap pressure.

The cooling system capacity can be found in Section 1. The cooling system should be inspected daily for leakage and damage. If leakage or damage is detected, take the ATV to an authorized Arctic Cat ATV dealer for service. Also, the coolant level should be checked periodically.

### CAUTION

Continued operation of the ATV with high engine temperature may result in engine damage or premature wear.

■NOTE: High engine RPM, low vehicle speed, or heavy load can raise engine temperature. Decreasing engine RPM, reducing load, and selecting an appropriate transmission gear can lower the temperature.

When filling the cooling system, use a coolant/water mixture which will satisfy the coldest anticipated weather conditions of the area in accordance with the coolant manufacturer's recommendations. While the cooling system is being filled, air pockets may develop; therefore, run the engine for five minutes after the initial fill, shut the engine off, and then fill the cooling system to the bottom of the stand pipe in the radiator neck.

### Checking/Filling

- On the 700/1000, remove the two screws from the front of the radiator access panel. On the 450/550/650, remove the four screws securing the radiator access panel.



F1465A





FI476

2. On the 700/1000, lift the front of the access panel; then slide the panel forward to disengage the two rear tabs.
3. On the 700/1000, move the panel rearward until free of the rack. On the 450/550/650, move the panel forward until free of the ATV.
4. On Mud Pro models, remove four cap screws securing the snorkel housing to the front inspection panel; then remove two cap screws from the rear of the snorkel housing.

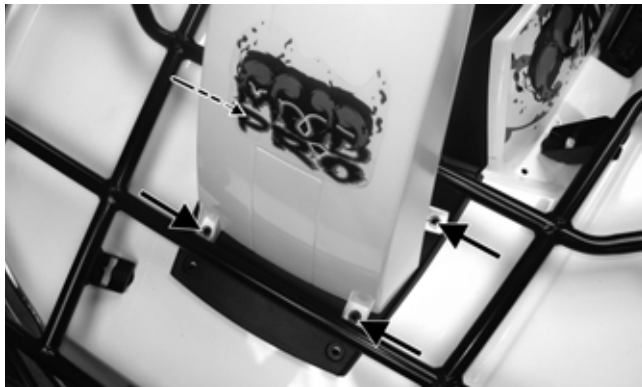

MP006A

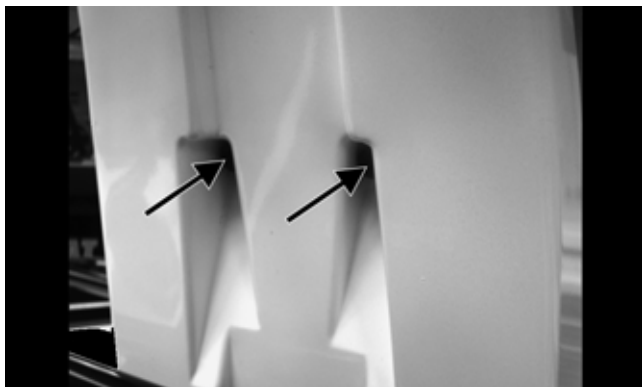

MP007A

5. Separate the front of the snorkel housing from the rear; then remove the snorkel housing.



MP003

6. Remove two reinstallable rivets and remove the splash guard. The radiator cap can now be accessed in front of the snorkels.
7. Carefully rotate the radiator cap counterclockwise to release pressure; then remove the cap.

2

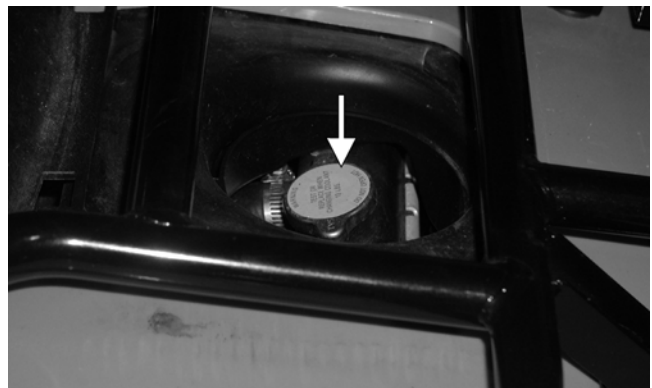

CF142A

8. Add coolant as necessary; then install the radiator cap and access panel or snorkel housing.

■NOTE: Use a good quality, biodegradable glycol-based, automotive-type antifreeze.

**WARNING**

Never check the coolant level when the engine is hot or the cooling system is under pressure.

**CAUTION**

After operating the ATV for the initial 5-10 minutes, stop the engine, allow the engine to cool down, and check the coolant level. Add coolant as necessary.

**Front Differential/Rear Drive Lubricant**

■NOTE: On the 700 Mud Pro and 1000 models, the rear drive incorporates a shock-limiting clutch pack in the gear case input assembly that is designed to cushion driveline shock.



**CAUTION**

Any lubricant used in place of the recommended gear case lubricant could result in premature failure of the shock limiter. Do not use any lubricant containing graphite or molybdenum additives or other friction-modified lubricants as these may cause severe damage to shock limiter components.

When changing the lubricant, use approved SAE 80W-90 hypoid gear lube.

To check lubricant, remove the fill plug; the lubricant level should be 1 in. below the threads of the plug. If low, add SAE approved 80W-90 hypoid gear lubricant as necessary.

To change the lubricant, use the following procedure.

1. Place the ATV on level ground.
2. Remove each fill plug.

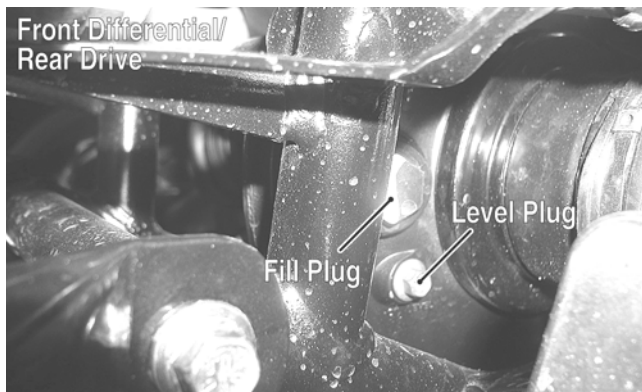

AL677C

3. Drain the lubricant into a drain pan by removing in turn the drain plug from each.

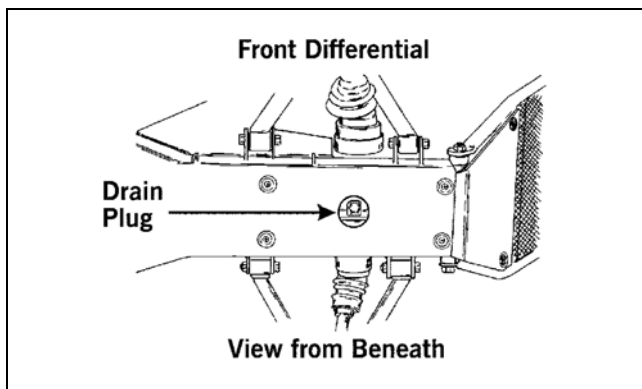

ATV0082A

Rear Drive

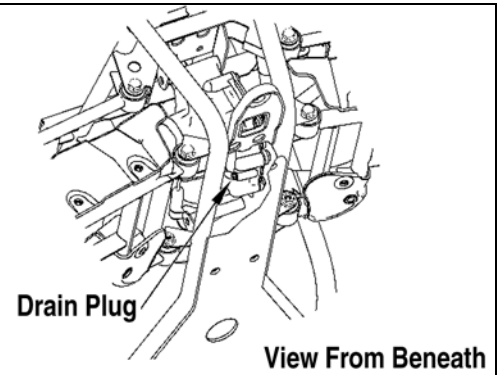

737-651B

4. After all the lubricant has been drained, install the drain plugs and tighten to 45 in.-lb.
5. Pour the appropriate amount of approved SAE 80W-90 hypoid gear lubricant into the filler hole.
6. Install the fill plugs.

■NOTE: If the differential/rear drive lubricant is contaminated with water, inspect the drain plug, fill plug, and/or bladder.

**CAUTION**

Water entering the outer end of the axle will not be able to enter the rear drive unless the seals are damaged.

**Nuts/Bolts/Cap Screws**

Tighten all nuts, bolts, and cap screws. Make sure rivets holding components together are tight. Replace all loose rivets. Care must be taken that all calibrated nuts, bolts, and cap screws are tightened to specifications (see Section 1).

**Headlights/Taillight-Brakelight**

■NOTE: The bulb portion of a headlight is fragile. HANDLE WITH CARE. When replacing a headlight bulb, do not touch the glass portion of the bulb. If the glass is touched, it must be cleaned with a dry cloth before installing. Skin oil residue on the bulb will shorten the life of the bulb.

**WARNING**

Do not attempt to remove a bulb when it is hot. Severe burns may result.

To replace a headlight bulb, use the following procedure.

1. Rotate the bulb assembly counterclockwise and remove from the headlight housing; then disconnect from the wiring harness.

2. Connect the new bulb assembly to the wiring harness connector; then insert into the headlight housing and rotate fully clockwise.

To replace the taillight-brakelight bulb, use the following procedure.

1. Turn the bulb socket assembly counterclockwise and remove from the housing.

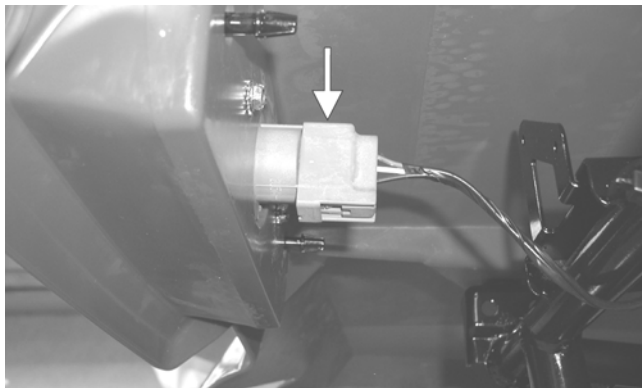

CF135A

2. Pull the bulb straight out of the socket; then insert a new bulb.

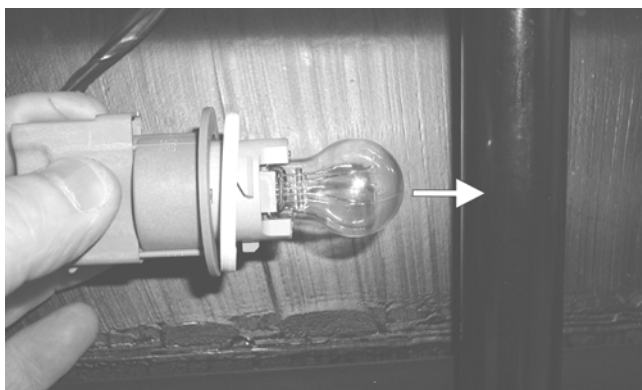

CF132A

3. Insert the bulb socket assembly into the housing and turn it clockwise to secure.

### CHECKING/ADJUSTING HEADLIGHT AIM

The headlights can be adjusted vertically and horizontally. The geometric center of the HIGH beam light zone is to be used for vertical and horizontal aiming.

1. Position the ATV on a level floor so the headlights are approximately 6.1 m (20 ft) from an aiming surface (wall or similar aiming surface).

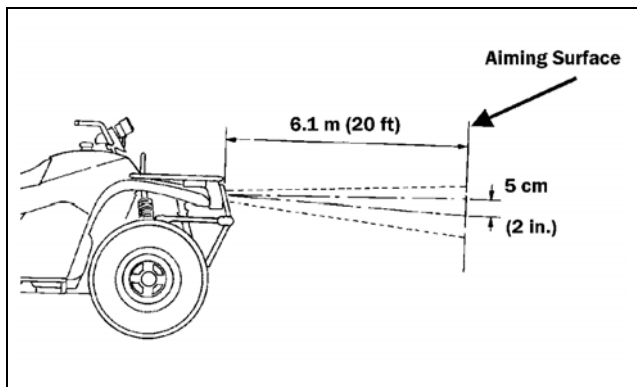

ATV-0070C

**NOTE:** There should be an average operating load on the ATV when adjusting the headlight aim.

2. Measure the distance from the floor to the mid-point of each headlight.
3. Using the measurements obtained in step 2, make horizontal marks on the aiming surface.
4. Make vertical marks which intersect the horizontal marks on the aiming surface directly in front of the headlights.
5. Switch on the lights. Make sure the HIGH beam is on. DO NOT USE LOW BEAM.
6. Observe each headlight beam aim. Proper aim is when the most intense beam is centered on the vertical mark 5 cm (2 in.) below the horizontal mark on the aiming surface.
7. Adjust each headlight by turning the adjuster knob clockwise to raise the beam or counterclockwise to lower the beam.

2

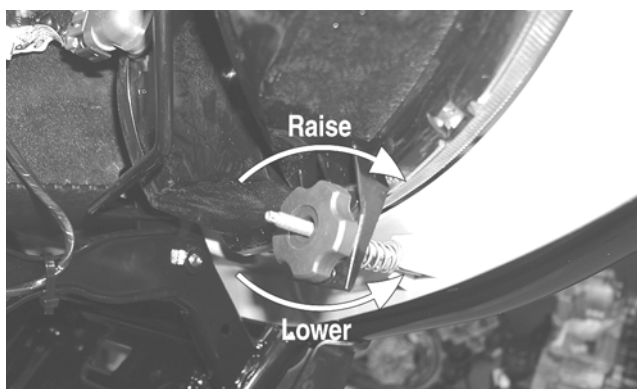

CD714A